

GRADE 1

Mathematics

Teacher Toolkit:
CAPS Aligned Lesson Plans
and Resources

TERM 4

Acknowledgement:

The lesson plans and resources in this document were initially developed by the Gauteng Department of Education as part of the Gauteng Primary Literacy and Mathematics Strategy. They are being used in KwaZulu-Natal under a memorandum of agreement between the two provinces. They have been revised for the context of KZN on the advice of district and provincial officials.

Published in 2020 by Jika iMfundo.

Jik'iMfundo is a programme to improve learning outcomes, funded by the National Education Collaboration Trust, the KwaZulu-Natal Department of Education and others.

The Programme to Improve Learning Outcomes (PILO)
The Shed, The Pines, 9 Gordon Hill Road, Parktown, 2193
Tel: + 27 10 880 2431
Email: admin@pilo.co.za

© The National Education Collaboration Trust (NECT)

A partnership involving business, civil society, government and labour that strives to improve education outcomes.

The National Education Collaboration Trust
Ground Floor, Block D, Lakefield Office Park, 272 West Avenue, Centurion, 0163
Tel: +27 12 752 6200
Email: info@nect.org.za
Web: www.nect.org.za

No part of this publication may be reproduced without prior permission from the NECT.

ISBN: 978-1-990918-03-2

Materials development by the PILO team along with representatives from the districts and province.

Publishing management by The Word Horse, www.wordhorse.co.za
Design by COMPRESS.dsl, www.compressdsl.com
Typesetting by The Maas Group, www.themaasgroup.com

CONTENTS

About the Lesson Plans and Resources _____	2	Lesson 25: Groups of 5 and groups of 2 up to 20 _____	80
Lesson Plan Outline _____	5	Week 6 _____	83
Week 1 _____	8	Lesson 26: Sharing 5s up to 20 _____	83
Lesson 1: Number 16 – place value _____	8	Lesson 27: Sharing 2s up to 20 _____	86
Lesson 2: Number 17 – place value _____	11	Lesson 28: Sharing with remainders _____	89
Lesson 3: Number 18 – place value _____	14	Lesson 29: Data _____	92
Lesson 4: Number 19 – place value _____	17	Lesson 30: Data _____	95
Lesson 5: Number 20 – place value _____	20	Week 7 _____	98
Week 2 _____	23	Lesson 31: Geometric patterns _____	98
Lesson 6: Capacity _____	23	Lesson 32: 2-D shapes – recognition _____	101
Lesson 7: Ordinal numbers _____	26	Lesson 33: 2-D shapes – round and straight sides _____	104
Lesson 8: Ordinal numbers _____	29	Lesson 34: 2-D shapes – size and colour _____	107
Lesson 9: Addition and subtraction _____	32	Week 8 _____	110
Lesson 10: Addition and subtraction _____	35	Lesson 35: Symmetry _____	110
Week 3 _____	38	Lesson 36: Doubling _____	113
Lesson 11: Addition and subtraction _____	38	Lesson 37: Halving _____	116
Lesson 12: Addition and subtraction _____	41	Lesson 38: Time _____	119
Lesson 13: Addition and subtraction – money _____	44	Printable Resources _____	122
Lesson 14: Addition and subtraction – money _____	47		
Lesson 15: 3-D objects – balls and boxes _____	50		
Week 4 _____	53		
Lesson 16: Position and views _____	53		
Lesson 17: Position and views _____	56		
Lesson 18: Mass _____	59		
Lesson 19: Mass _____	62		
Lesson 20: Number patterns – 2s, 5s and 10s to 100 _____	65		
Week 5 _____	68		
Lesson 21: Number patterns – 2s, 5s and 10s to 100 _____	68		
Lesson 22: 5s and 2s – repeated addition up to 20 _____	71		
Lesson 23: 5s and 2s – repeated addition up to 20 _____	74		
Lesson 24: Groups of 5 and groups of 2 up to 20 _____	77		

ABOUT THE LESSON PLANS AND RESOURCES

The lesson plans and resources in this book are part of the Teacher Toolkit for Mathematics Grade 1 Term 4. The other documents in the toolkit are:

- a CAPS Aligned Planner, Tracker and Assessment Resources
- a bilingual CAPS Learner Activity Book
- a bilingual Dictionary of Mathematical Terms.

A variety of printable resources that you can copy for yourself and/or your learners are included at the end of the lesson plans in this book. They include:

- a) Resource sheets:** These comprise a variety of teaching and learning aids that are needed in certain lessons. The specific resource sheet, and the number of copies needed, is noted in the relevant lesson plan and in the tracker so that you can prepare them in advance.
- b) Mental mathematics challenge cards:** A pack of eight mental mathematics challenge cards (solutions are provided) is included to allow for routine weekly mental mathematics activities that you can record.
- c) Enrichment activity cards:** A pack of 32 enrichment activity cards (solutions are provided) are included for learners who complete the day's classwork activities ahead of the class.

A. About the lesson plans

The lesson plans give detailed information about how to teach a CAPS-aligned lesson every day. By following the lesson plans, you will ensure that you cover the content and assessment tasks specified in the curriculum and give your learners the best possible chance of developing the knowledge and skills required for Mathematics in this grade.

1. Curriculum alignment

The lessons are sequenced according to the topics in the CAPS and weighted according to requirements given there, and the programme of assessment is accommodated. Every lesson shows the CAPS content and skill being focussed on in the lesson.

2. Links to the DBE workbooks

Links are given in the lessons to all appropriate DBE worksheets. Note that the pages referred to are all from the 2017 edition of the DBE workbook. This changes very little from year to year, but if you use a different edition of the workbook, you should check that the worksheet on the same page in this different edition is still appropriate for your purpose.

Bilingual learner material is provided in the LoLT of the school in accordance with the Foundation Phase language policy.

3. Broad overview of the content of the lesson plans

Each lesson plan provides a set of steps to guide you in delivering the lesson. In addition, it contains learner activities that will help learners develop the concepts and skills set for the lesson. These include the required daily mental mathematics activity, whole class oral activities led by the teacher, classwork and homework activities, as well as answers for these. All the classwork and homework activities are also given in the Learner Activity Books, so that learners do not need to waste time copying them down. In Grade 1, learners write in in these activity books, and so need a new one each term. In the other grades, activity books should not be written in and should be returned at the end of each term for use the following year.

4. Assessment

The programme of assessment suggested in the lesson plans and tracker is adaptable and can be adjusted to comply with the CAPS as amended by Circular S1 of 2017 and provincial responses to this. The lesson plans and tracker provide a number of resources to support both formal and informal assessment in this programme, as noted below:

- Oral and practical activities which you can use to assess learners as you observe and interact with them in class are provided in the tracker. Rubrics

and checklists with criteria for this assessment are provided in the tracker, at the end of the table for the week in which the assessment is suggested.

- There is an item bank of written assessment questions, with marking memos in the tracker. Items that are relevant to a specific lesson are noted in the resources column for the lesson in the tracker.
- A complete overview of the programme of assessment for the term is given in the tracker. This shows you when it is suggested you carry out both formal (and informal) assessment tasks which are oral, practical and written. This will assist you in planning and monitoring your assessment programme.
- There is also recommended mark record sheet in the tracker. This has been drawn up to assist you as you record your marks on SA-SAMS.

5. *Managing the lesson programme*

A set of orientation activities on eight different topics aligned with the CAPS baseline assessment requirements is provided for the start of the term. You should use all or a selection of these activities in the first week of term before the formal teaching of the numbered lesson plans begins.

The formal curriculum for Term 4 of Grade 1 is covered in a set of 38 numbered, fully developed lesson plans, paced to cover a 40-day teaching term. There are two consolidation lessons in the term – one in Week 7 and one in Week 8. You can use this time to catch up, remediate or consolidate the content covered in the term's formal lessons. Learners could complete the worksheets from the DBE workbook related to topics taught in the term if they did not manage to do them in the course of the term.

Each lesson is designed to last 90 minutes. If your school's timetable has different period lengths, you will have to adjust the amount of work done in each lesson to accommodate this. However, each school should allow seven hours for Mathematics each week, and it should be possible to fit in all the work for the week, even if the lengths of periods are not the same as in the lesson plans.

6. *Sequence adherence and pacing*

Each lesson and its contents have been carefully sequenced. It is therefore important that lessons are not skipped. Should you miss a Mathematics lesson for any reason, you should continue the next day from where you last left off. Do not leave a lesson out. You may need to speed up the pace of delivery to catch up a missed lesson by covering the lesson concept content of two consecutive days in one day. To do this you could cut out or cut back on some of the routine activities like mental mathematics or homework reflection to save time until you are back on track with the expected delivery of the plans. You need to prepare very well as this will help you to manage the full set of lessons at the appropriate pace.

7. *Lesson preparation*

The lesson plans provide a detailed lesson design for you to follow. However, to deliver the lessons successfully **you must do the necessary preparation yourself**. The information below outlines some key aspects of preparation.

- a) **Term focus:** Start by looking at the CAPS document and **orientating** yourself to the CAPS content focus for the term. It is important that you are clear about the content focus, as this will frame everything you do in your Mathematics lessons during the term.
- b) **Prepare resources:** The resources needed for each lesson are listed in each lesson plan and in the tracker. It is very important that you check what is required for each lesson ahead of time, so that you have all your resources ready for use every day (e.g. counters, number boards, paper cut-outs, examples of shapes, etc.).
 - **Your lessons will not succeed if you have not prepared properly for them.**
 - If you do not have all the necessary resources readily available, see how best you can improvise, e.g. get learners to collect bottle tops or small stones to be used for counting, or make your own flard cards/number boards using pieces of cardboard and a marker pen. Collect empty cool drink cans, cereal boxes, washing powder boxes, plastic bottles, etc. for the **shop activity** in the week long in advance, so that you have all the necessary goods to stock your shop.

- Use newspapers and magazines to cut out pictures that could be used in your teaching. If you have access to the internet, search for and print out pictures that you may need to use as illustrations in your lessons.
- c) **Prepare for the written classwork and homework activities:** When preparing your lessons, check the lesson activity requirements. In some instances you will need to write information or draw some diagrams on the board that you will use while you do the interactive whole-class-teaching component of the lesson. Also mark the homework activities as often as you can, so that you can give useful feedback to the learners each day, and be aware of any difficulties learners are having as soon as they become apparent.
- d) **Prepare to teach the concepts and skills associated with the lesson topic:** Think carefully about what it is that you will teach your learners in the lesson. Prepare a short introduction to the topic, so that you can explain it in simple terms to your learners. Make sure you have prepared for the teaching of the concepts before you teach – you need to be able to explain new Mathematics content and skills to the learners. Be sure you have gone through the oral teaching activities provided in the lesson plans. Also make sure that you have thought about how to use the resources in the lesson effectively. This preparation needs to be done in advance, so that you do not waste time during the lesson. Be sure you are familiar with the sequence of activities in the lesson plan. Prepare yourself to assist learners with any questions they might have during the lesson. Also give some thought to how you will accommodate learners with barriers to learning.
- e) **Lesson pace:** Think about how much time you will spend on each activity. It is important to plan how you will manage the pace of the lesson carefully; otherwise you will not manage to cover all the lesson content. Not all learners work at the same pace. You need to determine the pace – be guided by the average learner and the recommendations in the lesson plans. Be careful not to slow down to the pace of the slowest learners as this will disadvantage the other learners.
- f) **Organisation of learners:** Think about how you will organise learners when they do the classwork activities. Will they work alone, in pairs or in small groups? How will you organise the pairs or groups if you choose to use them? You need to organise the learners quickly at the beginning of the lesson, so that you do not waste too much time on this.
- g) **Inclusive education:** Consider the needs of any learners with barriers to learning in your class, and how best you can support them. The DBE has published some excellent materials to support you in working with learners with learning barriers. Two such publications are:
 Directorate Inclusive Education, Department of Basic Education (2011) *Guidelines for Responding to Learner Diversity in the Classroom Through Curriculum and Assessment Policy Statements*. Pretoria. www.education.gov.za, www.thutong.doe.gov.za/InclusiveEducation.
- Directorate Inclusive Education, Department of Basic Education (2010) *Guidelines for Inclusive Teaching and Learning. Education White Paper 6. Special needs education: Building an inclusive education and training system*. Pretoria. www.education.gov.za, www.thutong.doe.gov.za/InclusiveEducation.

LESSON PLAN OUTLINE

Lesson Plan Outline

Each lesson plan has several components. Information about each is given in the table below. This information tells you how to use each of the components of the lesson plans and how they fit together to create a well-paced and properly scaffolded Mathematics lesson each day. You need to read this outline as you prepare each lesson until you are fully familiar with the general lesson plan components, pace and structure.

Lesson topic	Each lesson has a topic with specific detail about the day's lesson.
CAPS topics	The CAPS content related to the day's lesson is given here, together with the reference number for this content in the expansion of content section in the CAPS document for this term. You are encouraged to look at the CAPS to read about the selected curricular topics for the day.
Lesson vocabulary	A list of all mathematical terms used in the lesson is given here. The terms, with full explanations and diagrams, are also provided in the bilingual lesson vocabulary Dictionary that is part of your Toolkit. Go through the lesson vocabulary each day as you prepare for the lesson. These terms are important, as they are the language of Mathematics that each learner needs to learn and understand in order to build a solid foundation and understanding of this subject. It is important to explain these words to your learners and to practise using them with your learners during the lesson.
Prior knowledge and lesson concept	<p>The prior knowledge and lesson concept section gives information about content that learners should have learnt in earlier grades that will be built on in this lesson.</p> <ul style="list-style-type: none"> • You need to read through this section when you do your lesson preparation. • No time is allocated to this part of the plan because it does not form part of the teaching of the day's lesson. • The information about prior knowledge may help you to assist learners who struggle to understand the content of the lesson because there are gaps in the prior knowledge on which the lesson is based. You can use the information about prior knowledge to help you identify such gaps and to diagnose learners' needs in relation to content they do not yet know that may be preventing them from understanding the day's lesson. • Remediation may be needed on prior knowledge that you notice is not properly in place.
Assessment	<p>A reminder to refer to the tracker for the formal oral, practical or written assessment activity for the day is given here.</p> <ul style="list-style-type: none"> • On-going informal and formal oral and practical assessment should be done virtually every day in your class. This means you will record a mark for a few learners for a certain criterion from the curriculum each day. Decide how many learners to assess every day, so that you assess your whole class in the time allocated to each assessment activity. • Rubrics and checklists to guide you in giving ratings for the oral and practical assessments are given in the tracker at the end of the tracker table for each week. Each day you need to use the appropriate rubric or checklist for the assessment activity of that day. • Written test items and their memos are provided in the tracker. Links to these items are given in the resources column of the tracker to show you in which lesson they should best be used. • A <i>Suggested Assessment Record Sheet</i> that you can use to record your term marks is given in the tracker. This sheet aligns with the SA-SAMS.

Lesson Plan Outline

Remediation	<p>Optional as required. You could use these activities to assist slower learners. You need to decide, based on your observation of the learners while you are teaching the lesson content, whether to use this content and with which learners. It will be done with a smaller group of learners/individual learners while the rest of the class is working through the classwork activity from the LAB.</p>
Enrichment	<p>Optional as required. You could use these activities as extra work for fast learners or others interested in doing them.</p> <p>Activities that you can use for enrichment opportunities for learners who have completed the lesson activities are provided in a set of enrichment activity cards at the end of the lesson plan set. Ideally, you should photocopy the enrichment cards, paste them onto cardboard and laminate them, so that they can be used as a resource, not only this year, but in the future as well.</p> <p>Learners should work on these cards independently or with their peers who have also completed the classwork. They may work through the cards in any order. You may need to explain some of the activities to the learners who use them. You should tell them to ask questions if they have any.</p> <p>All learners who show an interest in the enrichment activities should be encouraged to work through the cards.</p>
Mental mathematics (15 minutes)	<p>This is the first component of the lesson. We recommend that you take at most 15 minutes to do the mental mathematics activity. There are two parts to the mental mathematics activity, a counting activity and a set of questions to drill number facts and basic mathematical strategies.</p> <p>Mental mathematics is not a concrete activity (as the title suggests). However, if there are learners who need concrete aids to complete the mental mathematics activities, we suggest that you allow them to use their fingers to count on.</p> <ul style="list-style-type: none"> • Observe which learners struggle with mental activities, and make sure you spend time to assist them to reach the required level of competence by offering remediation activities using concrete aids. • The answers to the ten mental mathematics questions are given in the answer column in the lesson plans. • It would be far better to do all ten questions per day, but if you find that your learners struggle to finish these in ten minutes, do a minimum of five questions. <p>There is a set of mental mathematics challenge cards at the end of the lesson plans. Learners write the answers to the questions given on these cards. We recommend that learners only do written mental mathematics once a week and oral mental mathematics on all the other days. You can use this work to obtain a mental mathematics activity mark each week.</p>
Correction/reflection on homework (15 minutes)	<p>This is the second component of the lesson. We recommend that you take 15 minutes to remediate and correct the previous day's homework. Read out answers to all of the homework questions. Let learners/peers mark the work. Also try to check homework yourself as often as you can.</p> <p>Choose one or two activities that you realise were problematic to work through in full with the whole class. In this part of the lesson you may reflect on the previous day's work. Allow learners the opportunity to write corrections as needed.</p>

Lesson Plan Outline

<p>Lesson content – concept development (30 minutes)</p>	<p>This is the third component of the lesson. It is the body of the lesson, in which learners are introduced to the new work planned for the day. We recommend that you actively teach your class for 30 minutes – going through the activities interactively with your learners.</p> <ul style="list-style-type: none"> • Activities on the content that you will teach with worked examples and suggested explanations are given. These activities have been carefully sequenced and scaffolded so that they support the teaching of the concepts for the day. You should work through each of these with your class. • It is important to manage the pace of the lesson carefully, otherwise you will not manage to cover all the lesson content. Once you have introduced the new concept, work through Activity 1 of the lesson with the whole class (or with learners in groups). Then immediately move on to the next activity, and provide a reasonable time for the learners to complete Activity 2, but do not wait for the last learner to finish before moving on. If there are further activities, continue pacing yourself in this way, so that you work through all of the activities in each lesson. A few activities are marked as <i>optional</i> – these need only be done if you have sufficient time.
<p>Classwork activity from Learner Activity Book (25 minutes)</p>	<p>This is the fourth component of the lesson. We recommend that you allocate 25 minutes to classwork. You could go over one or two of the classwork activities orally with the whole class before allowing the class to complete the activities independently (individually or in groups).</p> <ul style="list-style-type: none"> • Learners do most of the activities in their Mathematics books (an exercise book for learner Mathematics writing activities). Some activities are done in the DBE workbook. • You should allow the learners opportunities to do these activities alone, in pairs and in groups so that they experience working alone as well as with their peers. • Wrap up the lesson each day by giving the learners the answers to the classwork, and allow time for corrections to be written if and when necessary. <p>The bilingual Learner Activity Book contains all of the daily classwork activities.</p>
<p>Homework activity from Learner Activity Book (5 minutes)</p>	<p>This is the fifth and final component of the lesson. We have allocated five minutes to give you time to tell the learners about the homework each day. Here you find a set of activities on the day's content that you can set for your class to do for homework. This is to consolidate the Mathematics that you have taught them that day. Homework also promotes learner writing and development of their mathematical knowledge.</p> <p>The bilingual Learner Activity Book contains all of the daily homework activities.</p>
<p>Reflection</p>	<p>Each day there is a reminder to note your thoughts about the day's lesson. You will use these notes as you plan and prepare for your teaching.</p>

WEEK 1

LESSON 1: NUMBER 16 – PLACE VALUE

Teacher's notes

CAPS topics: 1.1 Count objects, 1.2 Count forwards and backwards, 1.16 Mental mathematics, 1.3 Number symbols and number names, 1.4 Describe, compare and order numbers, 1.5 Place value, 1.6 Problem solving techniques.

Lesson vocabulary: Forwards, backwards, more than, less than, describe, compare, order, number names, number sentence, number symbol.

Prior knowledge: Learners should have been taught how to:

- Recognise, identify and read number symbols **0** to **80**.
- Recognise, identify, read write number names **one** to **ten**.
- Describe, compare and order a collection of objects up to 15.

Concepts:

- Recognise, identify, read and write number symbol **16**.
- Describe, compare and order numbers up to 16.
- Recognise the place value of the two-digit number 16.

Resources: Counters, flard cards (see *Printable Resources*), whiteboards/scrap paper.

DBE workbook activities relevant to this lesson:

- DBE Worksheet 97 (pp. 66 and 67).

Assessment: Refer to the tracker for today's formal/informal oral, practical or written assessment activity.

Remediation: Give each learner 16 counters. Say: *Count out 10 counters. Put them in a group on your whiteboards/ scrap paper. Draw a circle around the group. Now count out 6 more counters. Let's count all of them. (1, 2, 3... 16.)*

Ask: *Is there an easier way to count all these counters? (We can count on from 10 because we know that there are 10 in this group.) We can say 16 is 1 ten and 6 ones. Do the same with any other available objects if necessary.*

Enrichment: See enrichment activity cards.

1. Mental mathematics

1.1 Counting (5 minutes)

- Count in ones forwards and backwards starting and ending at different numbers in the range 0–60, e.g. *Start at 11 and count on in ones. Stop at 46. Start at 41 and count back in ones. Stop at 16.*

1.2 Mental mathematics activity (10 minutes)

	What is 1 less than:	Answer
1.	16?	15
2.	13?	12
3.	18?	17
4.	11?	10
5.	15?	14

	What is 2 more than:	Answer
6.	14?	16
7.	18?	20
8.	17?	19
9.	11?	13
10.	15?	17

2. Correction/reflection on homework (15 minutes)

Reflection/remediation based on previous day's work/homework.

3. Lesson content – concept development (30 minutes)

The first five lessons extend the learners' knowledge of numbers and number names up to the number 20. In each lesson the learners work with counters. Each time they have to group ten counters together and then observe how many counters are left ungrouped. The scaffolded steps guide the learners to use the language of place value (tens and units/ones), with reference to the concrete activities that they have just done. The repetitive pattern of speech used each time the concrete activities are done will help learners to establish the concept of number being established – how to recognise, name and write number symbols for the numbers in the extended number range (15–20).



Activity 1: Learners work in groups

- Give each group of learners sixteen counters.
- Ask the learners to make a group of ten counters.
- *How many counters are left ungrouped? (6)*
- *How many have we got altogether? We can count on from 10. Let's touch the counters and count on from 10 to 16. (11, 12, 13, 14, 15, 16)*
- Ask the learners: *What can you tell me about 16? (Answer may vary but guide learners to speak about the number 16 in terms of tens and units. Assist them if necessary by modeling the answer: We can say 16 is 1 ten and 6 ones/units.)*

Activity 2: Whole class activity

- Write the number symbol and number name 16 on the board.
- Draw 16 counters on the board.
- Point to the counters on the board and ask the learners: *How many counters do you see? (Count together – 16)*
- *This is how we write the number symbol 16.* Point to the symbol 16.
- Point to the number name sixteen. *This is how we write the number name sixteen.*
- Learners must copy the symbol on their whiteboards/scrap paper.

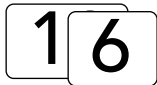
Activity 3: Whole class activity

- Give the learners flard cards. 
- Show them how to show 16 using the cards. 
- Show learners that we can say: 
- Say: *We can write this as a number sentence on the board. $10 + 6 = 16$.*

4. Classwork activity from LAB (25 minutes) (See next page)

5. Homework activity from LAB (5 minutes) (See next page)

6. Reflection on lesson



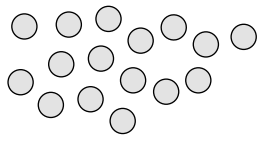
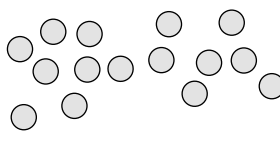
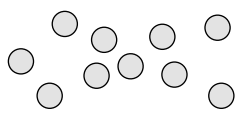
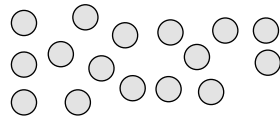

Term 4 Lesson 1: Number 16 – place value

Classwork

1. Circle 10 counters and fill in the missing numbers.

	a) <input type="text"/> ten and <input type="text"/> ones (1 ten and 6 ones)		b) <input type="text"/> ten and <input type="text"/> ones (1 ten and 5 ones)
	c) <input type="text"/> ten and <input type="text"/> ones (1 ten and 0 ones)		d) <input type="text"/> ten and <input type="text"/> ones (1 ten and 6 ones)

2. Draw blocks to show the following:

- a) 1 ten and 6 ones ()
- b) 1 ten and 5 ones ()
- c) 1 ten and 0 ones ()
- d) 1 ten and 3 ones ()

3. Fill in:

- a) $16 = 10 + \square$ (6)
- b) $16 = \square + 6$ (10)

Homework

1. Draw blocks to show the following:

- a) 1 ten and 4 ones. ()
- b) 1 ten and 2 ones. ()

2. Fill in:

- a) $15 = 10 + \square$ (5)
- b) $15 = \square + 5$ (10)

LESSON 2: NUMBER 17 – PLACE VALUE

Teacher's notes

CAPS topics: 1.1 Count objects, 1.2 Count forwards and backwards, 1.16 Mental mathematics, 1.3 Number symbols and number names, 1.4 Describe, compare and order numbers, 1.5 Place value, 1.6 Problem solving techniques.

Lesson vocabulary: Forwards, backwards, more than, less than, describe, compare, order, number names, bigger, smaller, number symbol, number name.

Prior knowledge: Learners should have been taught how to:

- Recognise, identify and read number symbols **0** to **80**.
- Recognise, identify, read write number names **one** to **ten**.
- Describe, compare and order a collection of objects up to 16.

Concepts:

- Compare numbers up to 17.
- Recognise, identify, read and write number symbol **17**.
- Describe, compare and order numbers up to 17.
- Recognise the place value of the two-digit number 17.

Resources: Counters, flard cards, whiteboards/scrap paper.

DBE workbook activities relevant to this lesson:

- DBE Worksheet 98 (pp. 68 and 69).

Assessment: Refer to the tracker for today's formal/informal oral, practical or written assessment activity.

Remediation: Give each learner 17 counters. Say: *Count out 10 counters. Put them in a group on your whiteboards/scrap paper. Draw a circle around the group. Now count out 7 more counters. Let's count all of them. (1, 2, 3... 17.)* Ask: *Is there an easier way to count all these counters? (We can count on from 10 because we know that there are 10 in this group.) We can say 17 is 1 ten and 7 ones.* Do the same with any other available objects if necessary. Compare the numbers 16 and 17 to consolidate the number 16.

Enrichment: See enrichment activity cards.

1. Mental mathematics

1.1 Counting (5 minutes)

- Count in ones forwards and backwards starting and ending at different numbers in the range 0–60, e.g. *Start at 21 and count on in ones. Stop at 56. Start at 32 and count back in ones. Stop at 5.*

1.2 Mental mathematics activity (10 minutes)

	Which is the bigger number?	Answer
1.	13, 16	16
2.	11, 10	11
3.	16, 18	18
4.	19, 20	20
5.	15, 13	15

	Which is the smaller number?	Answer
6.	14, 12	12
7.	18, 11	11
8.	16, 17	16
9.	11, 20	11
10.	19, 15	15

2. Correction/reflection on homework (15 minutes)

Reflection/remediation based on previous day's work/homework.

3. Lesson content – concept development (30 minutes)

Note that the series of lessons (1 to 5) have a similar set of activities. This is done purposefully to consolidate and build the learners' understanding.



Activity 1: Learners work in groups

- Give each group of learners seventeen counters.
- Ask the learners to make a group of ten counters.
- Ask: *How many counters are left ungrouped? (7)*
- *How many counters have we got altogether? We can count on from 10. Let's touch the counters and count on from 10 to 17. (11, 12, 13, 14, 15, 16, 17)*
- Ask: *What can you tell me about 17? (Assist them if necessary by modeling the answer: We can say 17 is 1 ten and 7 ones.)*

Activity 2: Whole class activity

- Write the number symbol 17 and number name on the board.
- Draw 17 counters on the board.
- Point to the counters on the board and ask the learners: *How many counters do you see? (17)*
(Count together – 17)
- *This is how we write the number symbol 17.* Point to the symbol 17.
- Point to the number name *seventeen*. *This is how we write the number name seventeen.*
- Learners must copy the symbol on their whiteboards/scrap paper.

Activity 3: Whole class activity

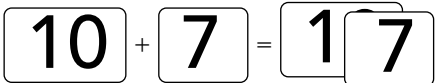
- Give the learners flard cards. 
- Show them how to show 17. 
- Show learners that we can say: 
- Say: *We can write this as a number sentence on the board. 10 + 7 = 17*

4. Classwork activity from LAB (25 minutes) (See next page)

5. Homework activity from LAB (5 minutes) (See next page)

6. Reflection on lesson



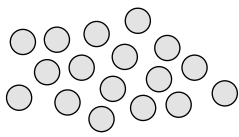
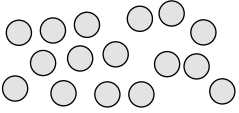
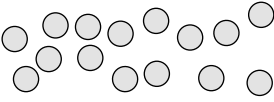
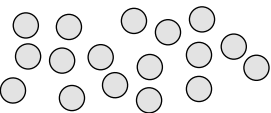

Term 4 Lesson 2: Number 17 – place value

Classwork

1. Circle 10 counters and fill in the missing numbers.

	a) <input type="text"/> ten and <input type="text"/> ones (1 ten and 7 ones)		b) <input type="text"/> ten and <input type="text"/> ones (1 ten and 6 ones)
	c) <input type="text"/> ten and <input type="text"/> ones (1 ten and 5 ones)		d) <input type="text"/> ten and <input type="text"/> ones (1 ten and 7 ones)

2. Draw blocks to show the following:

- a) 1 ten and 4 ones. ()
- b) 1 ten and 6 ones. ()
- c) 1 ten and 5 ones. ()
- d) 1 ten and 7 ones. ()

3. Fill in:

a) $17 = 10 + \square$ (7)

b) $17 = \square + 7$ (10)

Homework

1. Draw blocks to show the following:

a) 1 ten and 3 ones. ()

b) 1 ten and 0 ones. ()

2. Fill in:

a) $16 = 10 + \square$ (6)

b) $16 = \square + 6$ (10)

LESSON 3: NUMBER 18 – PLACE VALUE

Teacher's notes

CAPS topics: 1.1 Count objects, 1.2 Count forwards and backwards, 1.16 Mental mathematics, 1.3 Number symbols and number names, 1.4 Describe, compare and order numbers, 1.5 Place value, 1.6 Problem solving techniques.

Lesson vocabulary: Forwards, backwards, more than, less than, describe, compare, order, number name, number symbol, number sentence.

Prior knowledge: Learners should have been taught how to:

- Recognise, identify and read number symbols **0** to **80**.
- Recognise, identify, read write number names **one** to **ten**.
- Describe, compare and order a collection of objects up to 17.

Concepts:

- Compare numbers up to 18.
- Recognise, identify, read and write number symbol **18**.
- Describe, compare and order numbers up to 18.
- Recognise the place value of the two-digit number 18

Resources: Counters, flard cards, whiteboards/scrap paper.

DBE workbook activities relevant to this lesson:

- DBE Worksheet 99 (pp. 70 and 71).

Assessment: Refer to the tracker for today's formal/informal oral, practical or written assessment activity.

Remediation: Give each learner 18 counters. Say: *Count out 10 counters. Put them in a group on your whiteboards/ scrap paper. Draw a circle around the group. Now count out 8 more counters. Let's count all of them. (1, 2, 3... 18.)* Ask: *Is there an easier way to count all these counters? (We can count on from 10 because we know that there are 10 in this group.) We can say 18 is 1 ten and 8 ones.* Do the same with any other available objects if necessary and compare the numbers 16, 17 and 18.

Enrichment: See enrichment activity cards.

1. Mental mathematics

1.1 Counting (5 minutes)

- Count in ones forwards and backwards starting and ending at different numbers in the range 0–70, e.g. *Start at 33 and count on in ones. Stop at 62. Start at 59 and count back in ones. Stop at 27.*

1.2 Mental mathematics activity (10 minutes)

	Which is less?	Answer
1.	11 or 13?	11
2.	13 or 10?	10
3.	18 or 16?	16
4.	12 or 19?	12
5.	15 or 14?	14

	Which is more?	Answer
6.	9 or 11?	11
7.	17 or 7?	17
8.	10 or 20?	20
9.	13 or 15?	15
10.	18 or 16?	18

2. Correction/reflection on homework (15 minutes)

Reflection/remediation based on previous day's work/homework.

3. Lesson content – concept development (30 minutes)



Activity 1: Learners work in groups

- Give each group of learners eighteen counters.
- Ask the learners to make a group of ten counters.
- Ask: *How many counters are left ungrouped?* (8)
- *How many counters have we got altogether? We can count on from 10. Let's touch the counters and count on from 10 to 18. (11, 12, 13, 14, 15, 16, 17, 18)*
- Ask: *What can you tell me about 18?* (Assist them if necessary by modeling the answer: *We can say 18 is 1 ten and 8 ones.*)

Activity 2: Whole class activity

- Write the number symbol 18 and number name on the board.
- Draw 18 counters on the board.
- Point to the counters on the board and ask the learners: *How many counters do you see?* (Count together – 18)
- Point to the symbol 18. *This is how we write the number symbol 18.*
- Point to the number name *eighteen*. *This is how we write the number name eighteen.*
- Learners must copy the symbol on their whiteboards/scrap paper.

Activity 3: Whole class activity

- Give the learners flard cards. 
- Show them how to show 18. 
- Show learners that we can say: 
- Say: *We can write this as a number sentence on the board. 10 + 8 = 18*

4. Classwork activity from LAB (25 minutes) (See next page)

5. Homework activity from LAB (5 minutes) (See next page)

6. Reflection on lesson







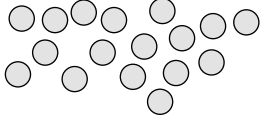
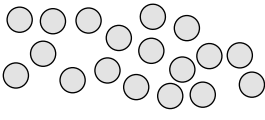
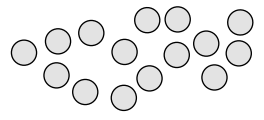
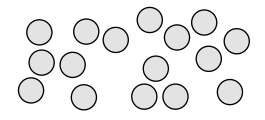

Term 4 Lesson 3: Number 18 – place value

Classwork

1. Circle 10 counters and fill in the missing numbers.

	<p>a) <input type="text"/> ten and <input type="text"/> ones</p> <p>(1 ten and 7 ones)</p>		<p>b) <input type="text"/> ten and <input type="text"/> ones</p> <p>(1 ten and 8 ones)</p>
	<p>c) <input type="text"/> ten and <input type="text"/> ones</p> <p>(1 ten and 5 ones)</p>		<p>d) <input type="text"/> ten and <input type="text"/> ones</p> <p>(1 ten and 6 ones)</p>

2. Draw blocks to show the following:







- a) 1 ten and 7 ones. () )
- b) 1 ten and 8 ones. () )
- c) 1 ten and 3 ones. () )
- d) 1 ten and 6 ones. () )

3. Fill in:

- a) $18 = 10 + \square$ (8)
- b) $18 = \square + 8$ (10)

Homework

1. Draw sticks to represent the following:

- a) one ten and 6 ones. ( )
- b) one ten and 8 ones. ( )
- c) one ten and 7 ones. ( )

2. Complete:

- a) $12 = 10 + \square$ (2)
- b) $12 = \square + 2$ (10)

LESSON 4: NUMBER 19 – PLACE VALUE

Teacher's notes

CAPS topics: 1.1 Count objects, 1.2 Count forwards and backwards, 1.16 Mental mathematics, 1.3 Number symbols and number names, 1.4 Describe, compare and order numbers, 1.5 Place value, 1.6 Problem solving techniques.

Lesson vocabulary: Forwards, backwards, more than, describe, compare, order, number name, number symbol, number sentence.

Prior knowledge: Learners should have been taught how to:

- Recognise, identify and read number symbols **0** to **80**.
- Recognise, identify, read write number names **one** to **ten**.
- Describe, compare and order a collection of objects up to 18.

Concepts:

- Compare numbers up to 19.
- Recognise, identify, read and write number symbol **19**.
- Describe, compare and order numbers up to 19.
- Recognise the place value of the two digit number 19

Resources: Counters, flard cards, whiteboards/scrap paper.

DBE workbook activities relevant to this lesson:

- DBE Worksheet 100 (pp. 72 and 73).

Assessment: Refer to the tracker for today's formal/informal oral, practical or written assessment activity.

Remediation: Give each learner 19 counters. Say: *Count out 10 counters. Put them in a group on your whiteboards/scrap paper. Draw a circle around the group. Now count out 9 more counters. Let's count all of them. (1, 2, 3... 19.)* Ask: *Is there an easier way to count all these counters? (We can count on from 10 because we know that there are 10 in this group.) We can say 19 is 1 ten and 9 ones.* Do the same with any other available objects if necessary.

Enrichment: See enrichment activity cards.

1. Mental mathematics

1.1 Counting (5 minutes)

- Count in ones forwards and backwards starting and ending at different numbers in the range 0–70, e.g. *Start at 48 and count on in ones. Stop at 65. Start at 67 and count back in ones. Stop at 41.*

1.2 Mental mathematics activity (10 minutes)

	What is 1 more than:	Answer
1.	18?	19
2.	15?	16
3.	11?	12
4.	19?	20
5.	12?	13

	What is 1 more than:	Answer
6.	10?	11
7.	17?	18
8.	13?	14
9.	16?	17
10.	14?	15

2. Correction/reflection on homework (15 minutes)

Reflection/remediation based on previous day's work/homework.

3. Lesson content – concept development (30 minutes)



Activity 1: Learners work in groups

- Give each group of learners nineteen counters.
- Ask the learners to make a group of ten counters.
- Ask: *How many counters are left ungrouped? (9)*
- *We can count on from 10. Let's touch the counters and count on from 10 to 19.*
(11, 12, 13, 14, 15, 16, 17, 18, 19)
- Ask: *What can you tell me about 19? (Assist them if necessary by modeling the answer: We can say 19 is 1 ten and 9 ones.)*

Activity 2: Whole class activity

- Write the number symbol 19 and number name on the board.
- Draw 19 counters on the board.
- Point to the counters on the board and ask the learners: *How many counters do you see? (19)*
(Count together – 19)
- Point to the symbol 19. *This is how we write the number symbol 19.*
- Point to the number name *nineteen*. *This is how we write the number name nineteen.*
- Learners must copy the symbol on their whiteboards/scrap paper. Discuss with the learners the relationship between 16, 17, 18 and 19.
- For example, 16 is one ten and 6 ones but 19 is one ten and 9 ones. Write the numbers on the board as you discuss them.

Activity 3: Whole class activity

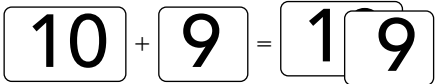
- Give the learners flard cards. 
- Show them how to show 19. 
- Show learners that we can say: 
- Say: *We can write this as a number sentence on the board. 10 + 9 = 19*

4. Classwork activity from LAB (25 minutes) (See next page)

5. Homework activity from LAB (5 minutes) (See next page)

6. Reflection on lesson

Term 4 Lesson 4: Number 19 – place value

Classwork

1. Circle 10 counters and fill in the missing numbers.

	a) <input type="text"/> ten and <input type="text"/> ones (1 ten and 9 ones)		b) <input type="text"/> ten and <input type="text"/> ones (1 ten and 7 ones)
	c) <input type="text"/> ten and <input type="text"/> ones (1 ten and 8 ones)		d) <input type="text"/> ten and <input type="text"/> ones (1 ten and 5 ones)

2. Draw blocks to show the following:

- a) 1 ten and 2 ones. ()
- b) 1 ten and 8 ones. ()
- c) 1 ten and 6 ones. ()
- d) 1 ten and 9 ones. ()

3. Fill in:

- a) $19 = 10 + \square$ (9)
- b) $19 = \square + 9$ (10)

Homework

1. Draw sticks to represent the following:

- a) one ten and 9 ones. ()
- b) one ten and 7 ones. ()
- c) one ten and 8 ones. ()

2. Complete:

- a) $14 = 10 + \square$ (4)
- b) $14 = \square + 4$ (10)

LESSON 5: NUMBER 20 – PLACE VALUE

Teacher's notes

CAPS topics: 1.1 Count objects, 1.2 Count forwards and backwards, 1.16 Mental mathematics, 1.3 Number symbols and number names, 1.4 Describe, compare and order numbers, 1.5 Place value, 1.6 Problem solving techniques.

Lesson vocabulary: Forwards, backwards, more than, less than, describe, compare, order, number name, number symbol, number sentence, bigger, smaller.

Prior knowledge: Learners should have been taught how to:

- Recognise, identify and read number symbols **0** to **80**.
- Recognise, identify, read write number names **one** to **ten**.
- Describe, compare and order a collection of objects up to 19.

Concepts:

- Compare numbers up to 20.
- Recognise, identify, read and write number symbol **20**.
- Describe, compare and order numbers up to 20.
- Recognise the place value of the two digit number 20

Resources: Counters, flard cards, whiteboards/scrap paper.

DBE workbook activities relevant to this lesson:

- DBE Worksheet 101 (pp. 74 and 75).

Assessment: Refer to the tracker for today's formal/informal oral, practical or written assessment activity.

Remediation: Give each learner 20 counters. Say: *Count out 10 counters. Put them in a group on your whiteboards/ scrap paper. Draw a circle around the group. Now count out 10 more counters. Put them in a group. Draw a circle around the group. Let's count all of them. (1, 2, 3.... 20.)* Ask: *Is there an easier way to count all these counters? (We can count in tens because we know that there are 10 in each group – 10, 20.) We can say 20 is 2 tens and 0 ones. Do the same with any other available objects if necessary.*

Enrichment: See enrichment activity cards.

1. Mental mathematics

1.1 Counting (5 minutes)

- Count in ones forwards and backwards starting and ending at different numbers in the range 0–80, e.g. *Start at 53 and count on in ones. Stop at 79. Start at 75 and count back in ones. Stop at 50.*

1.2 Mental mathematics activity (10 minutes)

	Complete the following:	Answer
1.	What is 1 less than 18?	17
2.	What is 1 more than 15?	16
3.	What is 2 less than 11?	9
4.	What is 2 more than 18?	20
5.	Which is bigger: 2 or 12?	12

	Complete the following:	Answer
6.	What is 1 less than 20?	19
7.	What is 1 more than 17?	18
8.	What is 2 less than 13?	11
9.	What is 2 more than 6?	8
10.	Which is smaller: 18 or 14?	14

2. Correction/reflection on homework (15 minutes)

Reflection/remediation based on previous day's work/homework.

3. Lesson content – concept development (30 minutes)

Activity 1: Learners work in groups

- Give each group of learners twenty counters.
- Ask the learners to make groups of ten counters.
- Ask: *How many groups of ten counters can we make? (2) How many counters are left ungrouped? (0)*
- *We can count in tens. Let's touch the groups and count in tens. (10, 20)*
- Ask: *What can you tell me about 20? (Assist them if necessary by modeling the answer: We can say 20 is 2 tens and 0 ones.)*
- Discuss the difference between 10 and 20 in terms of groups of 10. *(10 is one group of ten and 20 is two groups of ten.)*
- Revise how many ones make 10 and how many ones make 20. *(There are ten ones in 10 and there are twenty ones in 20.)*

Activity 2: Whole class activity

- Write the number symbol and number name on the board.
- Draw 20 counters on the board.
- Point to the counters on the board and ask the learners: *How many counters do you see? (20)* (Count together – 20)
- Point to the symbol 20. *This is how we write the number symbol twenty.*
- Point to the number name twenty. *This is how we write the number name twenty.*
- Learners must copy the symbol on their whiteboards/scrap paper.

Activity 3: Whole class activity

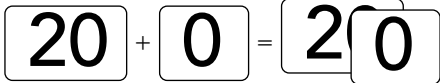
- Give the learners flard cards. 
- Show learners that we can say: 
- Say: *We can write this as a number sentence on the board. 20 + 0 = 20*
- Discuss the use of the 0 as a place holder in the number 20. It shows that there are 'no units' in the units place. (And there are 2 tens in the tens place.)

4. Classwork activity from LAB (25 minutes) (See next page)

5. Homework activity from LAB (5 minutes) (See next page)

6. Reflection on lesson







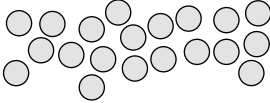
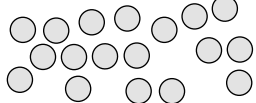
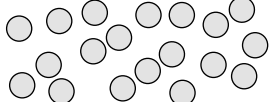
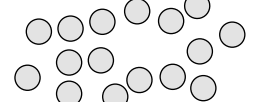

Term 4 Lesson 5: Number 20 – place value

Classwork

1. Circle 10 counters and fill in the missing numbers.

	a) <input type="text"/> ten and <input type="text"/> ones (2 tens and 0 ones)		b) <input type="text"/> ten and <input type="text"/> ones (1 ten and 8 ones)
	c) <input type="text"/> ten and <input type="text"/> ones (1 ten and 9 ones)		d) <input type="text"/> ten and <input type="text"/> ones (1 ten and 6 ones)

2. Draw blocks to show the following:

- a) 2 tens and 0 ones. () )
- b) 1 tens and 8 ones. () )
- c) 1 tens and 9 ones. () )
- d) 1 tens and 2 ones. () )

3. Fill in:

- a) $20 = 20 + \square$ (0)
- b) $20 = \square + 10$ (10)

Homework

1. Fill in to show tens and units:

- a) $11 = 10 + \square$ (1)
- b) $11 = \square + 1$ (10)
- c) $18 = 10 + \square$ (8)
- d) $18 = \square + 8$ (10)
- e) $13 = 10 + \square$ (3)
- f) $13 = \square + 3$ (10)

WEEK 2

LESSON 6: CAPACITY

Teacher's notes

CAPS topics: 1.2 Count forwards and backwards, 1.16 Mental mathematics, 4.4 Capacity.

Lesson vocabulary: Forwards, backwards, capacity, estimate, measure, compare, most, more, least, less, non-standard measures, order, record, container, cup, unit (of measurement).

Prior knowledge: Learners should have been taught how to:

- Compare and order the amount of liquid (volume) in two containers placed next to each other. Learners check by pouring into a third container if necessary.
- Compare and order the amount of liquid that two containers can hold if filled (capacity).
- Use language to talk about the comparison, e.g. more than, less than, full, empty.
- Estimate, measure, compare, order and record the capacity of containers by using non-standard measures, e.g. spoons and cups.

Concepts:

- Estimate, measure, compare, order and record the capacity of containers by using non-standard measures, e.g. spoons and cups.

Resources: Containers of various shapes and sizes, e.g. cups, spoons, jugs, yoghurt tubs, ice cream tubs, margarine tubs, plastic cold drink bottles, scrap paper – one per each group of learners.

DBE workbook activities relevant to this lesson:

- DBE Worksheet 126 (p. 125).

Assessment: Refer to the tracker for today's formal/informal oral, practical or written assessment activity.

Remediation: Show the learners two containers. Ask: *Which container do you think will hold the most water/sand? How many cups of water/sand will be needed to fill each container?* Learners need to be encouraged to estimate. Help the learners to measure how many cups of water/sand are needed to fill each container. Ask: *Was your estimate correct?*

Enrichment: See enrichment activity cards.

1. Mental mathematics

1.1 Counting (5 minutes)

- Count forwards and backwards in twos between 0–100.

1.2 Mental mathematics activity (10 minutes)

	Complete the following:	Answer
1.	$7 + 1 = \underline{\quad}$	8
2.	$10 - 2 = \underline{\quad}$	8
3.	$4 + 1 = \underline{\quad}$	5
4.	$9 - 6 = \underline{\quad}$	3
5.	$5 + 5 = \underline{\quad}$	10

	Complete the following:	Answer
6.	$8 - 5 = \underline{\quad}$	3
7.	$9 + 1 = \underline{\quad}$	10
8.	$3 + 6 = \underline{\quad}$	9
9.	$7 - 6 = \underline{\quad}$	1
10.	$6 - 6 = \underline{\quad}$	0

2. Correction/reflection on homework (15 minutes)

Reflection/remediation based on previous day's work/homework.

3. Lesson content – concept development (30 minutes)

This lesson provides learners with an opportunity to recap the concept of capacity. Remember to use all of the vocabulary and encourage the learners to use all of the vocabulary as well. Refer to the Jika iMfundo dictionary if you need to for definitions and examples of the vocabulary used in this lesson.

Activity 1: Learners work in groups

- Give the learners three different containers, e.g. a small yoghurt tub, an ice cream tub and a margarine tub.
- Ask: *Which container do you think has the biggest capacity?* (Ice cream tub.)
- *Which container do you think has the smallest capacity?* (Yoghurt tub.)
- Ask the learners to take a cup and then measure how many cups of water or sand will fill each container.
- Make sure that the learners fill each container right to the top and emphasise that filled 'to capacity' is filled to the top.

Activity 2: Learners work in groups

- Give each group of learners a sheet of scrap paper.
- In this activity learners will record the findings from the previous activity.
- Ask the learners to draw the three different containers on the paper and then record the number of cups of water/sand that is required to fill each container.
- The learners can then write *most* and *least* under the correct pictures.

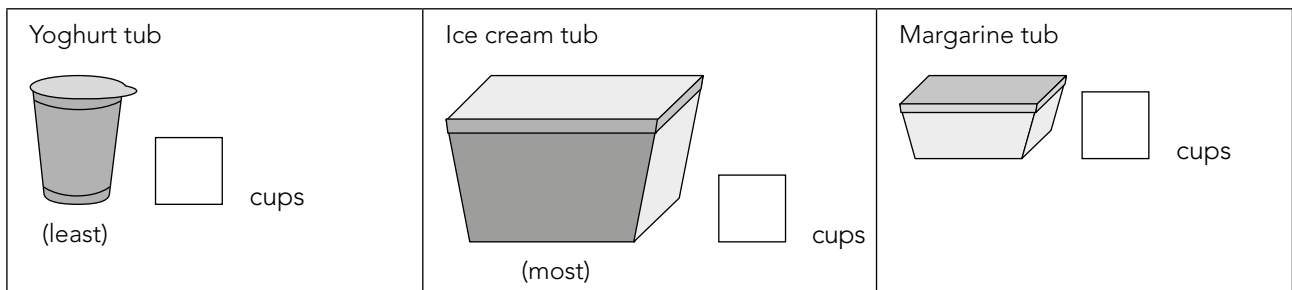

4. Classwork activity from LAB (25 minutes) (See next page)

5. Homework activity from LAB (5 minutes) (See next page)

6. Reflection on lesson



Term 4 Lesson 6: Capacity

Classwork

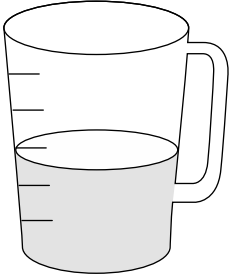
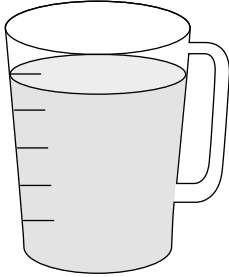
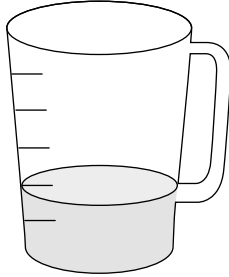
1. Circle the container that has the most. Draw a cross over the container that has the least.

a)		b)		c)	
		(most)		(least)	

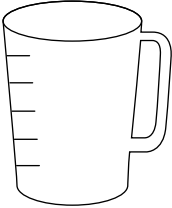
2. Are the containers full or empty? Colour the correct word.

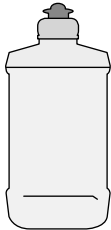
	full		(full)		(full)
	(empty)		empty		empty

3. Solve the following problem. Draw the picture to help you.

Gogo uses 4 cups of milk to make a pudding. If she doubles the recipe, how much milk will she need?

Answer:

() (8) cups of milk

Homework

- Mom needs 2 apples to make an apple pie. If she doubles the recipe, how many apples will she need?
($2 + 2 = 4$ apples)
- Find three different containers at home. Draw them in your homework book.
- Circle the one that you think will hold the most water in red. Label it – **most**.
- Circle the one that you think will hold the least water in blue. Label it – **least**.

LESSON 7: ORDINAL NUMBERS

Teacher's notes

CAPS topics: 1.1 Count objects, 1.2 Count forwards and backwards, 1.16 Mental mathematics, 1.4 Describe, compare and order numbers.

Lesson vocabulary: Forwards, backwards, less than, order, number line, ordinal number, first, second, third, fourth, fifth, sixth, seventh, eighth, ninth, tenth, last, place, position, circle, triangle.

Prior knowledge: Learners should have been taught how to:

- Recognise, identify and read number symbols **0** to **80**.
- Describe, compare and order a collection of objects up to 20.
- Count out objects reliably to 40.

Concepts:

- Use ordinal numbers to show order, place or position.

Resources: Whiteboards/scrap paper, coloured pencils, chairs.

DBE workbook activities relevant to this lesson:

- DBE Worksheet 105 (pp. 82 and 83).

Assessment: Refer to the tracker for today's formal/informal oral, practical or written assessment activity.

Remediation: Draw ten stick people on the board. Use different colours or shapes for each stick person's clothing. Then point and name each stick person's position on the board. Say: *First, second, third, fourth, fifth, sixth, seventh, eighth, ninth, tenth or last*. Ask the learners to point and repeat each position after you. Ask: *What colour is the third person's clothes? What shape is the sixth person's skirt?* etc.

Enrichment: See enrichment activity cards.

1. Mental mathematics

1.1 Counting (5 minutes)

- Count forwards and backwards in twos between 0–100.

1.2 Mental mathematics activity (10 minutes)

	Which is less?	Answer
1.	13 or 15?	13
2.	19 or 17?	17
3.	11 or 12?	11
4.	20 or 18?	18
5.	14 or 12	12

	Which is less?	Answer
6.	10 or 20?	10
7.	9 or 19?	9
8.	16 or 15?	15
9.	13 or 10?	10
10.	14 or 16?	14

2. Correction/reflection on homework (15 minutes)

Reflection/remediation based on previous day's work/homework.

3. Lesson content – concept development (30 minutes)

Ordinal number concept is different to pure number concept. Ordinal numbers are used to indicate the position in an ordered set of objects. Learners were introduced to ordinal numbers in Grade R but this is the Grade 1 learners' first opportunity to learn more about ordinal numbers. Refer to the *Jika iMfundo* dictionary if you need to for definitions and examples of the vocabulary used in this lesson.

Activity 1: Whole class activity

- Using the activity that follows, recap how you use ordinal numbers to denote position – write the words and number symbols first (1st), second (2nd), third (3rd), fourth (4th) and fifth (5th) on the board as examples of ordinal numbers.
- Draw five objects on the board, for example:



- Ask the learners (in a random order) what position each shape is in. For example: *Which is the third shape in the row of shapes I have drawn?* (The triangle is the third shape.) Etc.

Activity 2: Whole class activity

- Place 10 chairs in the front of the class.
- Call up one learner and say: *Sit on the second chair.*
- Discuss with them (if necessary) how to find the second chair.
- Call up another learner and say: *Sit on the eighth chair.*
- Call up more learners and ask them to sit on the first/third/fourth/fifth/sixth/seventh/ninth/tenth chair.
- When all the chairs are occupied, ask the rest of the learners:
 - *Who is sitting on the seventh chair?*
 - *Who is sitting on the last chair?*
- Continue asking questions:
 - *Who is sitting on the first/third/fourth/fifth/sixth/ninth/tenth chair?*

Activity 3: Whole class activity

Ask the learners to draw 10 squares on their whiteboards/scrap paper. Give the following instructions:

- Cross out the sixth square.
- Draw a triangle in the ninth square.
- Write a number 3 in the fifth square.
- Draw a circle in the third square.
- Write a number 8 in the first square.
- Draw a face in the last square.

(Answer:

8		○		3	⊗			△	☺
---	--	---	--	---	---	--	--	---	---

)

4. Classwork activity from LAB (25 minutes) (See next page)

5. Homework activity from LAB (5 minutes) (See next page)

6. Reflection on lesson

Term 4 Lesson 7: Ordinal numbers

Classwork

FINISH



1. Answer the following. Circle the correct answer.

a) Who came first?	buck	(cheetah)
b) Who came last?	(snail)	tortoise
c) Who came third?	buck	(rabbit)
d) Who came seventh?	(elephant)	cat
e) Who came second?	giraffe	(buck)
f) Who came eighth?	(frog)	cat
g) Who came fourth?	elephant	(dog)
h) Who came ninth?	(tortoise)	snail
i) Who came fifth?	cheetah	(cat)
j) Who came sixth?	(giraffe)	dog

2. Draw 10 circles in your maths book:

(Learners must draw ten circles and follow the instructions. Colours cannot be shown in this guide but you should check that they colour in the correct circles. Help them to use other ways of showing the circles in the different positions if they don't have all the colours, e.g. write the ordinal numbers – 1st, 2nd, 3rd, 4th, etc.)

- Colour the third circle red.
- Colour the ninth circle blue.
- Colour the fourth circle green.
- Colour the last circle yellow.
- Colour the seventh circle black.

Homework

Draw ten triangles in your homework book:

(As above learners must draw ten triangles and follow the instructions. Check that they have coloured the triangles in the different positions correctly according to the instructions, or that they can tell you in another way which triangles is in which position, e.g. write the ordinal numbers – 1st, 2nd, 3rd, 4th, etc.)

- Colour the second triangle green.
- Colour the eighth triangle red.
- Colour the fifth triangle yellow.
- Colour the ninth triangle black.
- Colour the sixth triangle blue.

LESSON 8: ORDINAL NUMBERS

Teacher's notes

CAPS topics: 1.1 Count objects, 1.2 Count forwards and backwards, 1.16 Mental mathematics, 1.4 Describe, compare and order numbers.

Lesson vocabulary: Describe, compare, order, forwards, backwards, number line, first, second, third, fourth, fifth, sixth, seventh, eighth, ninth, tenth, last, add, ordinal number, place, position, order, right hand side, left hand side, right, left, circle, triangle, square.

Prior knowledge: Learners should have been taught how to:

- Recognise, identify and read number symbols **0** to **80**.
- Describe, compare and order a collection of objects up to 20.
- Count out objects reliably to 40.

Concepts:

- Describe, compare and order numbers up to 20.
- Use ordinal numbers to show order, place or position.

Resources: Whiteboards/scrap paper, coloured pencils.

DBE workbook activities relevant to this lesson:

- N/A

Assessment: Refer to the tracker for today's formal/informal oral, practical or written assessment activity.

Remediation: Draw ten counters on the board. Use different colours or shapes to differentiate between them. Then point and name each counter on the board. Say: *This counter is first/second/third/ fourth/fifth/sixth/seventh/eighth/ninth/tenth or last.* Ask the learners to point and repeat after you. Ask: *What colour is the third counter? What shape is the sixth counter? etc.*

Enrichment: See enrichment activity cards.

1. Mental mathematics

1.1 Counting (5 minutes)

- Count forwards and backwards in fives between 0–100.

1.2 Mental mathematics activity (10 minutes)

	Add the following:	Answer
1.	$1 + 8 = \underline{\quad}$	9
2.	$2 + 5 = \underline{\quad}$	7
3.	$7 + 3 = \underline{\quad}$	10
4.	$5 + 4 = \underline{\quad}$	9
5.	$3 + 5 = \underline{\quad}$	8

	Add the following:	Answer
6.	$5 + 1 = \underline{\quad}$	6
7.	$3 + 4 = \underline{\quad}$	7
8.	$8 + 0 = \underline{\quad}$	8
9.	$6 + 4 = \underline{\quad}$	10
10.	$9 + 1 = \underline{\quad}$	10

2. Correction/reflection on homework (15 minutes)

Reflection/remediation based on previous day's work/homework.

3. Lesson content – concept development (30 minutes)

In this lesson learners consolidate ordinal number concept by locating objects in a given ordinal position and by naming the position of an object in an ordered set of objects.

Activity 1: Whole class activity

- Learners draw 10 circles on their whiteboards/scrap paper. Do the following as a class:

Cross out the ninth circle.	Draw a face in the third circle.
Draw a triangle in the last circle.	Write a number 5 in the first circle.
Write a number 8 in the fourth circle.	Draw a square in the seventh circle.

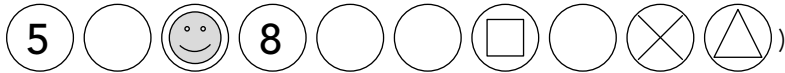
(Answer: )





- Ask learners: *Is the first circle on the left-hand side or the right-hand side?* (Show children which is which, if necessary.) *Why do you say that?* (Guide the children to respond: The first circle is on the left-hand side because we read from left to right, so we start on the left.)

Activity 2: Whole class activity

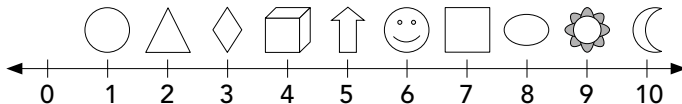
Learners work in groups of four.

- Draw a number line from one to ten on the board before the lesson.
- Draw a little picture/shape above each number. E.g.



- Ask the learners to draw the following on their whiteboards/scrap paper:
- Draw the picture which is sixth. ()
- Draw the picture which is second. ()
- Draw the picture which is ninth. ()
- Draw the picture which is first. ()
- Draw the picture which is last. ()

Activity 3: Whole class activity

- Point to the number line that you have drawn on the board and ask:
- In which position is the square?* (Seventh)
- In which position is the moon?* (Tenth)
- In which position is the circle?* (First)
- In which position is the arrow?* (Fifth)
- In which position is the box?* (Fourth)
- Guide the children to see that the number line provides a clear indication of where the first picture is by asking questions such as:
 - What number is underneath the first picture?* (1)
 - So that tells us that the first picture is number 1 in the row.*
 - What number is underneath the second picture?* Etc.

4. Classwork activity from LAB (25 minutes) (See next page)

5. Homework activity from LAB (5 minutes) (See next page)









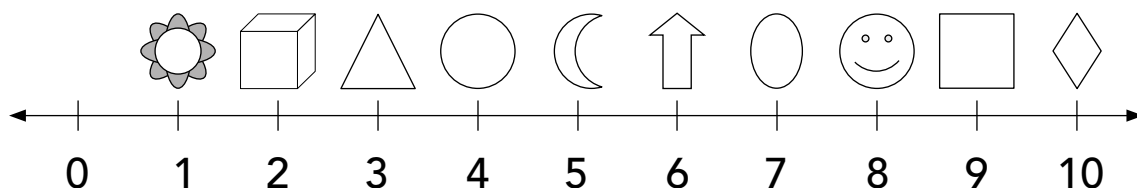











6. Reflection on lesson

Term 4 Lesson 8: Ordinal numbers

Classwork

1. Look at the number line and answer the following. Circle the correct answer.



Which is second?			Which is ninth?		
Which is last?			Which is fourth?		
Which is sixth?			Which is eighth?		
Which is seventh?			Which is first?		
Which is fifth?			Which is third?		

2. Draw ten small circles in your maths book:

(Learners must draw ten circles and follow the instructions. Colours cannot be shown in this guide but you should check that they colour in the correct circles. Help them to use other ways of showing the circles in the different positions if they don't have all the colours, e.g. write the ordinal numbers – 1st, 2nd, 3rd, 4th, etc.)

- Colour the second circle red.
- Colour the sixth circle blue.
- Colour the fifth circle green.
- Colour the tenth circle yellow.
- Colour the eighth circle black.

Homework

Draw ten triangles in your homework book:

(As above learners must draw ten triangles and follow the instructions. Check that they have coloured the triangles in the different positions correctly according to the instructions, or that they can tell you in another way which triangle is in which position, e.g. write the ordinal numbers – 1st, 2nd, 3rd, 4th, etc.)

- Colour the third triangle black.
- Colour the fourth triangle red.
- Colour the seventh triangle blue.

LESSON 9: ADDITION AND SUBTRACTION

Teacher's notes

CAPS topics: 1.1 Count objects, 1.2 Count forwards and backwards, 1.16 Mental mathematics, 1.6 Problem-solving techniques, 1.7 Addition and subtraction, 1.13 Addition and subtraction.

Lesson vocabulary: Forwards, backwards, addition, add, plus, more, subtraction, subtract, minus, take away, less, equals, the same as, makes, number sentence, symbol (operations).

Prior knowledge: Learners should have been taught how to:

- Recognise, identify and read number symbols **0** to **80**.
- Solve word problems using various techniques and explain solutions to problems up to 15.
- Add and subtract up to 15.

Concepts:

- Addition and subtraction and use of appropriate symbols (+, -, =, □).
- Solving word problems.

Resources: Whiteboards/scrap paper, counters.

DBE workbook activities relevant to this lesson:

- DBE Worksheet 102 (pp. 76 and 77).

Assessment: Refer to the tracker for today's formal/informal oral, practical or written assessment activity.

Remediation: Ask the learners to show you 12 counters. Ask them to add 4 counters. Ask them to count the counters that they now have. Help them to write the number sentence. ($12 + 4 = 16$) Learners can count all (1, 2, 3, 4, 5, 6, 7, 8, 9, 10, 11, 12, 13, 14, 15, 16) or they can count on. (12: 13, 14, 15, 16). Ask the learners to show you 17 counters. Ask them to take away 2 counters. Ask them to count the counters that they now have. Help them to write the number sentence.

○○○○○○○○○○○○○○○○○○○○ (17 - 2 = 15). Learners take away 2 counters and count the counters which are left. (1, 2, 3, 4, 5, 6, 7, 8, 9, 10, 11, 12, 13, 14, 15).

Enrichment: See enrichment activity cards.

1. Mental mathematics

1.1 Counting (5 minutes)

- Count in ones forwards and backwards starting and ending at different numbers in the range 0–100, e.g. Start at 52 and count on in ones. Stop at 76. Start at 82 and count back in ones. Stop at 36.

1.2 Mental mathematics activity (10 minutes)

	Subtract the following:	Answer
1.	$10 - 8 = \underline{\quad}$	2
2.	$9 - 5 = \underline{\quad}$	4
3.	$7 - 3 = \underline{\quad}$	4
4.	$6 - 4 = \underline{\quad}$	2
5.	$7 - 7 = \underline{\quad}$	0

	Subtract the following:	Answer
6.	$9 - 1 = \underline{\quad}$	8
7.	$5 - 5 = \underline{\quad}$	0
8.	$8 - 4 = \underline{\quad}$	4
9.	$6 - 3 = \underline{\quad}$	3
10.	$7 - 5 = \underline{\quad}$	2

2. Correction/reflection on homework (15 minutes)

Reflection/remediation based on previous day's work/homework.

3. Lesson content – concept development (30 minutes)

There are six lessons this term on addition and subtraction. Learners need to consolidate their understanding of these two operations and the relationship between them in these lessons. Remind learners that 'counting on' and 'counting back' are related (they do similar things – just one does it forwards and one does it backwards) encourage them to make this link. Remember that the more opportunities learners have to practice doing addition and subtraction the better. Do as many examples with them as possible – both numeric and in word problems.

Term 4 Lesson 9: Addition and subtraction

Classwork

- Fill in the missing numbers and draw the counters.
 - $11 + 4 = (15)$ (○○○○○○○○○○○○ ○○○○)
 - $13 + 5 = (18)$ (○○○○○○○○○○○○ ○○○ ○○○○○)
 - $14 + 1 + 3 = (18)$ (○○○○○○○○○○○○ ○○○○ ○ ○○○)
 - $17 - 6 = (11)$ (○○○○○○○○○○○○ ○~~○○○○○○~~)
 - $15 - 2 = (13)$ (○○○○○○○○○○○○ ○○○~~○○~~)
 - $16 - 3 = (13)$ (○○○○○○○○○○○○ ○○○~~○○○~~)
- Solve the word problems:
 - I have 10 marbles. I win 3 more. How many marbles do I have now?
($10 + 3 = 13$. I have (13) marbles.)
 - I see 14 birds. 2 fly away. How many are left?
($14 - 2 = 12$. There are (12) birds left.)

Homework

Fill in the missing numbers and draw the counters.

- $14 + 5 = \underline{\quad}$ ($14 + 5 = 19$) (○○○○○○○○○○○○ ○○○○ ○○○○○)
- $18 - 4 = \underline{\quad}$ ($18 - 4 = 14$) (○○○○○○○○○○○○ ○○○○~~○○○○~~)

LESSON 10: ADDITION AND SUBTRACTION

Teacher's notes

CAPS topics: 1.1 Count objects, 1.2 Count forwards and backwards, 1.16 Mental mathematics, 1.6 Problem-solving techniques, 1.7 Addition and subtraction, 1.13 Addition and subtraction.

Lesson vocabulary: Forwards, backwards, addition, add, plus, more, subtraction, subtract, minus, take away, less, equals, the same as, makes, symbol (operation), bigger.

Prior knowledge: Learners should have been taught how to:

- Recognise, identify and read number symbols **0** to **80**.
- Count out objects reliably to 40.
- Solve word problems using various techniques and explain solutions to problems up to 15.
- Add and subtract up to 15.

Concepts:

- Addition and subtraction.
- Use appropriate symbols (+, -, =, □).
- Solve word problems.

Resources: Whiteboards/scrap paper, counters.

DBE workbook activities relevant to this lesson:

- DBE Worksheet 103 (pp. 78 and 79).

Assessment: Refer to the tracker for today's formal/informal oral, practical or written assessment activity.

Remediation: Learners write the following on their whiteboards/scrap paper: $2 + 11 = \underline{\quad}$. Ask the learners to re-write the sum starting with the bigger number ($11 + 2 = \underline{\quad}$). The learners then work out the answer by counting on ($11 + 2 = 13$). Do the same with: $4 + 13 = (13 + 4 = 17)$.

Enrichment: See enrichment activity cards.

1. Mental mathematics

1.1 Counting (5 minutes)

- Count in ones forwards and backwards starting and ending at different numbers in the range 0–100, e.g. *Start at 29 and count on in ones. Stop at 69. Start at 97 and count back in ones. Stop at 71.*

1.2 Mental mathematics activity (10 minutes)

	Which is less?	Answer
1.	11 or 13?	11
2.	19 or 12?	12
3.	16 or 8?	8
4.	20 or 2?	2
5.	10 or 15?	10

	Which is more?	Answer
6.	19 or 7?	19
7.	14 or 11?	14
8.	17 or 13?	17
9.	10 or 20?	20
10.	8 or 16?	16

2. Correction/reflection on homework (15 minutes)

Reflection/remediation based on previous day's work/homework.

3. Lesson content – concept development (30 minutes)

In the first activity of this lesson you revise number concept with learners and identification of the bigger number when given a pair of numbers. The purpose of this revision is to get learners to focus on the bigger of a pair of numbers which they will use to count on from when they add.

Activity 1: Whole class activity

- Write numbers 1 to 10 on the board.
- Point to 4 and 7.
- Ask learners which number is bigger. (7)
- Do the same with: 5 and 9 (9), 2 and 6 (6), 10 and 1 (10), 7 and 2 (7).
- Write the numbers 11 to 20 on the board.
- Point to 16 and 11.
- Ask learners which number is bigger. (16)
- Do the same with: 15 and 19 (19), 16 and 12 (16), 11 and 10 (11), 17 and 12 (17).
- Give learners any number between 1 and 20 and ask them to give you a number that is bigger.
- Ask the learners if it is easier/quicker to start with the bigger or the smaller number when counting on or back when doing addition or subtraction sums. (The bigger number because it's quicker to count the smaller number rather than the bigger number.)

Activity 2: Whole class activity

Write an addition sum (e.g. $4 + 12 = \underline{\quad}$) on the board.

- Ask learners which is the bigger number. (12)
- Ask them if it would be quicker to count on 4 or to count on 12. (4)
- Rearrange $4 + 12$ as $12 + 4$ and count on from 12. Learners count on from 12: 13, 14, 15, 16.
- Ask: *Does it matter if I change the question from $4 + 12$ to $12 + 4$?* (No – the answer will be the same. I can interchange the pair of numbers being added when I am adding.)
- Write the following on the board and ask learners to place the bigger number first and then to count on:
 $3 + 15 = \underline{\quad}$ ($15 + 3 = 18$)
 $5 + 14 = \underline{\quad}$ ($14 + 5 = 19$)
 $7 + 12 = \underline{\quad}$ ($12 + 7 = 19$)
 $6 + 11 = \underline{\quad}$ ($11 + 6 = 17$)

Activity 3: Whole class activity

Solve the following word problem with your learners.

- Nolutando has 5 apples. Silo gave her 11 apples. How many apples does she have now?
- Ask *What is the question?* (How many apples does she have now?)
- Ask *What are the numbers?* (11 apples and 5 apples)
- Now pack it out with counters. ○○○○○○○○○○○○ ○○○○○○
- Ask *Should we add or subtract the numbers?* (Add)
- Show it with your counters and then write the number sentence. ($11 + 5 = 16$)
- If there is time make up more similar word problems for learners to solve. (Ask the learners to make up some problems if they would like to try.)

4. Classwork activity from LAB (25 minutes) (See next page)

5. Homework activity from LAB (5 minutes) (See next page)

6. Reflection on lesson

Term 4 Lesson 10: Addition and subtraction

Classwork

1. Which is the bigger number?

- a) 5 or 7? (7)
- b) 3 or 8? (8)
- c) 11 or 6? (11)
- d) 15 or 12? (15)
- e) 8 or 18? (18)
- f) 20 or 17? (20)

2. Add the following. Write the bigger number first.

- a) $4 + 12$ ($12 + 4 = 16$)
- b) $2 + 17$ ($17 + 2 = 19$)
- c) $3 + 16$ ($16 + 3 = 19$)
- d) $5 + 15$ ($15 + 5 = 20$)

3. Solve the following. You can make a drawing to help you.

Shakira had 4 oranges. Peter gave her 13 oranges. How many oranges does she have now?
($13 + 4 = 17$ ○○○○○○○○○○○○○ ○○○ ○○○○)

Homework

1. Add the following. Write the bigger number first.

- a) $5 + 13$ ($13 + 5 = 18$)
- b) $2 + 16$ ($16 + 2 = 18$)
- c) $3 + 11$ ($11 + 3 = 14$)
- d) $4 + 12$ ($12 + 4 = 16$)
- e) $6 + 14$ ($14 + 6 = 20$)

WEEK 3

LESSON 11: ADDITION AND SUBTRACTION

Teacher's notes

CAPS topics: 1.1 Count objects, 1.2 Count forwards and backwards, 1.16 Mental mathematics, 1.6 Problem-solving techniques, 1.7 Addition and subtraction, 1.13 Addition and subtraction.

Lesson vocabulary: Forwards, backwards, addition, add, plus, more, subtraction, subtract, minus, take away, less, equals, the same as, makes, smaller, bigger.

Prior knowledge: Learners should have been taught how to:

- Recognise, identify and read number symbols **0** to **80**.
- Solve word problems using various techniques and explain solutions to problems up to 15.
- Add and subtract up to 15.

Concepts:

- Addition and subtraction and use appropriate symbols (+, -, =, □).
- Solve word problems.
- Practice number bonds to 10.

Resources: Counters, Unifix blocks.

DBE workbook activities relevant to this lesson:

- DBE Worksheet 104 (pp. 80 and 81).

Assessment: Refer to the tracker for today's formal/informal oral, practical or written assessment activity.

Remediation: Give the learners 10 counters. Ask them to place 7 counters on the table. Ask: *How many more do you need to make 10?* (3) Do the same with: 1 and 9; 2 and 8; 4 and 6; 5 and 5. Now help the learners to add 7 and 5 by taking 3 away from the 5 and adding it to the 7 to make 10. $7 + 5 = \underline{\quad}$ ($7 + 3 + 2 = 12$).

Enrichment: See enrichment activity cards.

1. Mental mathematics

1.1 Counting (5 minutes)

- Count forwards and backwards in tens from any multiple between 0 and 100.
E.g. forwards 30, 40, 50...
backwards 100, 90, 80...

1.2 Mental mathematics activity (10 minutes)

	Complete the following:	Answer
1.	Which is less: 9 or 19?	9
2.	Which is more: 2 or 5?	5
3.	Which is smaller: 17 or 13?	13
4.	Add: $5 + 5 = \underline{\quad}$	10
5.	Subtract: $9 - 6 = \underline{\quad}$	3

	Complete the following:	Answer
6.	Which is less: 14 or 11?	11
7.	Which is more: 16 or 6?	16
8.	Which is bigger: 10 or 0?	10
9.	Add: $4 + 3 = \underline{\quad}$	7
10.	Subtract: $8 - 6 = \underline{\quad}$	2

2. Correction/reflection on homework (15 minutes)

Reflection/remediation based on previous day's work/homework.

3. Lesson content – concept development (30 minutes)

In this lesson learners find out how to simplify an addition sum by changing the numbers in the sum to make the calculation easier. But the changes they do need to compensate (make up for each other) so that the actual overall sum does not change. Look carefully at the examples before you teach this lesson so that you can explain the compensation to the learners.

Activity 1: Learners work in groups

- Give learners Unifix blocks.
- Ask the learners to place six blocks on the table. Ask them to add four blocks.



- Ask the learners how many blocks they have now. (10)
- Show the learners how you can swap the 10 loose blocks for a rod. (10 blocks connected.)



- Do the same with: 1 and 9; 2 and 8; 3 and 7; 5 and 5.
- Ask: *What was the total in each of the sums we just calculated?* (10)
- Remind learners that 10 units is the same as 1 ten. When we get 10 units we regroup to make 1 ten.

Activity 2: Learners work in groups

- Show the learners how to change a number to ten and then add or subtract ones. This strategy can be taught with quite low number ranges and later applied to higher numbers.

- Give learners 20 loose blocks.

- Ask learners to arrange the blocks to show $9 + 6 = \underline{\quad}$



- Ask the learners: *How many more do we need to add to 9 to make a ten?* (1)
- So, you can take away 1 from the 6 and add it to the 9 to make 10.
- Ask: *How did we change the sum?* (We subtracted from one number and added to the other number to make the calculation more simple.)
- Therefore $9 + 6$ can be written as $10 + 5 = 15$. Show it with Unifix blocks.



- Do the same with the following (in each case discuss the numeric working you do to change the sum):
 - $7 + 5 = \underline{\quad}$ ($10 + 2 = 12$)
 - $9 + 6 = \underline{\quad}$ ($10 + 5 = 15$)
 - $8 + 3 = \underline{\quad}$ ($10 + 1 = 11$)
 - $7 + 6 = \underline{\quad}$ ($10 + 3 = 13$)
 - $8 + 4 = \underline{\quad}$ ($10 + 2 = 12$)

4. Classwork activity from LAB (25 minutes) (See next page)

5. Homework activity from LAB (5 minutes) (See next page)

6. Reflection on lesson

Term 4 Lesson 11: Addition and subtraction

Classwork

1. Write number sentences for the following:

a)   ($10 + 5 = 15$)

b)   ($10 + 3 = 13$)

c)   ($10 + 6 = 16$)

d)  ($8 + 4 = 12$)

e)   ($10 + 2 = 12$)

f)  ($7 + 4 = 11$)

g)   ($10 + 1 = 11$)

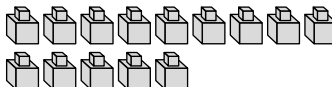
h)  ($9 + 5 = 14$)

i)   ($10 + 4 = 14$)

Homework

Write number sentences for the following:

1.  ($8 + 6 = 14$)

2.   ($10 + 4 = 14$)

3.  ($7 + 6 = 13$)

4.  ($9 + 2 = 11$)

5.   ($10 + 1 = 11$)

LESSON 12: ADDITION AND SUBTRACTION

Teacher's notes

CAPS topics: 1.1 Count objects, 1.2 Count forwards and backwards, 1.16 Mental mathematics, 1.6 Problem-solving techniques, 1.7 Addition and subtraction, 1.13 Addition and subtraction.

Lesson vocabulary: Forwards, backwards, addition, add, plus, more, subtraction, subtract, minus, take away, less than, equals, the same as, makes, symbol (operations), number line, number sentence.

Prior knowledge: Learners should have been taught how to:

- Recognise, identify and read number symbols **0** to **80**.
- Solve word problems using various techniques and explain solutions to problems up to 15.
- Add and subtract up to 15.

Concepts:

- Addition and subtraction.
- Use appropriate symbols (+, -, =, □)
- Solve word problems.
- Practice number bonds to 10.

Resources: Whiteboards/scrap paper.

DBE workbook activities relevant to this lesson:

- DBE Worksheet 72 (pp. 16 and 17).

Assessment: Refer to the tracker for today's formal/informal oral, practical or written assessment activity.

Remediation: Ask learners to put their finger on number 14 on their number line which was drawn in the whole-class activity. Ask learners to then jump forwards to 20. Ask learners how many jumps they made. (6) Ask learners to give you the verbal number sentence. ($14 + 6 = 20$) Ask learners to put their finger on 17 on their number line. Ask learners to jump backwards 5 places. Ask learners what number they landed on. (12) Ask learners to give you the verbal number sentence. ($17 - 5 = 12$) Repeat with other numbers.

Enrichment: See enrichment activity cards.

1. Mental mathematics

1.1 Counting (5 minutes)

- Count forwards and backwards in tens from any multiple between 0 and 100.

1.2 Mental mathematics activity (10 minutes)

	What is 1 more than	Answer
1.	18?	19
2.	11?	12
3.	17?	18
4.	14?	15
5.	19?	20

	What is 1 less than	Answer
6.	13?	12
7.	10?	9
8.	16?	15
9.	7?	6
10.	18?	17

2. Correction/reflection on homework (15 minutes)

Reflection/remediation based on previous day's work/homework.

3. Lesson content – concept development (30 minutes)

In this lesson learners work with number lines to add and subtract. Working with number lines helps learners to consolidate number concept, the relative size of numbers and to enable learners to visualise how things change when you add or subtract. It also helps learners to move away from counting and counters to do working when they add or subtract.

Activity 1: Whole class activity

- Ask learners to each draw a number line on their whiteboards/scrap paper.

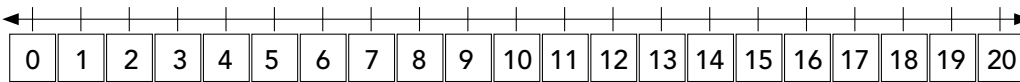

- Ask learners to put their finger on the number 11.
- Ask learners: *How many jumps will it take you to get from 11 to 19?* (8)
- *How can we write this as a number sentence?* ($11 + \underline{\quad} = 19$; $11 + 8 = 19$)
- Repeat with other numbers.

Activity 2: Whole class activity

- Ask learners to each draw a number line on their whiteboards/scrap paper.

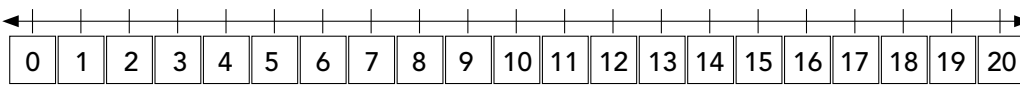

- Ask learners to put their finger on the number 17.
- Ask learners to jump backwards from 17 to 9, counting the jumps as they go. (1, 2, 3, 4, 5, 6, 7, 8 jumps.)
- Ask *How many jumps did you count?* (8)
- Ask *So, if we started on 17, jumped back 8, and landed on 9 – what does this ask us?* ($17 - 8 = 9$)
- Repeat with other numbers.

Activity 3: Whole class activity

Give learners addition and subtraction word problems. Learners can use a number line to help them solve the problems.

- Khulile has 15 marbles which are blue or green. 11 marbles are blue. How many marbles are green? (4 marbles.)
- Eva had 20 flowers. She gave 13 away. How many flowers are left? (7 flowers.)
- Kira has 18 pencils which are yellow or red. 12 pencils are yellow. How many pencils are red? (6 pencils.)
- Lindo had 14 books. He gave 9 to his friend. How many books does Lindo have left? (5 books.)
- Make up other word problems (ask learners to help if they would like to) so that there is lots of practice doing word problems.

4. Classwork activity from LAB (25 minutes) (See next page)

5. Homework activity from LAB (5 minutes) (See next page)

6. Reflection on lesson

Term 4 Lesson 12: Addition and subtraction

Classwork

1. Use the number lines to solve the following problems.

(NOTE: The number lines given for the solutions show unit counting. This corresponds to the style of counting demonstrated in the lesson. If learners show counting on the number line using other jumps, for example jumping in 2s or 3s or something else, this should also be accepted if is done correctly.)

a) $7 + \square = 13$ (6)

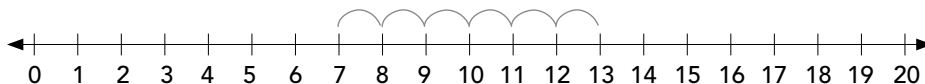

b) $9 + \square = 17$ (8)

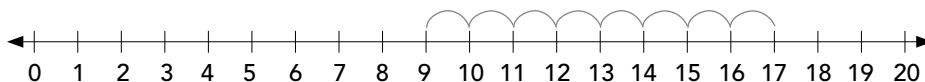

c) $19 - 3 = \square$ (16)

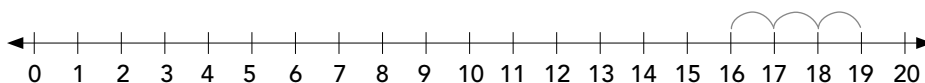

d) $16 - 7 = \square$ (9)

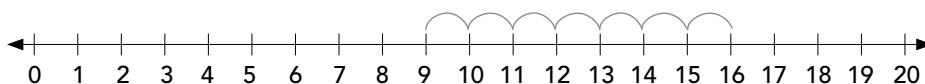

2. Solve the following:

a) $12 + \square = 19$ (7)

b) $13 - 5 = \square$ (8)

c) $9 + \square = 20$ (11)

d) $16 - 6 = \square$ (10)

e) $7 + \square = 15$ (8)

f) $20 - 4 = \square$ (16)

3. Solve the following problems:

a) Annie has 13 apples. 4 apples are red. How many are green?

($4 + \square = 13$; $4 + 9 = 13$; 9 apples are green.)

b) Jaco had 17 marbles. He lost 5. How many marbles did he have left?

($17 - 5 = \square$; $17 - 5 = 12$; 12 marbles.)

Homework

1. Solve the following:

a) $11 + \square = 16$ (5)

b) $16 - 4 = \square$ (12)

c) $10 + \square = 20$ (10)

d) $19 - 5 = \square$ (14)

LESSON 13: ADDITION AND SUBTRACTION – MONEY

Teacher's notes

CAPS topics: 1.2 Count forwards and backwards, 1.16 Mental mathematics, 1.6 Problem-solving techniques, 1.7 Addition and subtraction, 1.13 Addition and subtraction, 1.11 Money.

Lesson vocabulary: Forwards, backwards, addition, add, plus, more than, subtraction, minus, take away, less, equals, the same as, makes, money, change, coins, notes, value, rands, cents, number sentence, recognise, identify, totals, amount.

Prior knowledge: Learners should have been taught how to:

- Recognise, identify and read number symbols **0** to **80**.
- Solve word problems using various techniques and explain solutions to problems up to 20.
- Add and subtract up to 20.
- Recognise and identify South African coins.

Concepts:

- Recognise and identify South African coins 10c, 20c, 50c, R1,00, R2, R5; and bank notes R10, R20.
- Add and subtract up to 20.
- Solve money problems involving totals and change to R20 and in cents up to 20c cents.

Resources: Whiteboards/scrap paper, cut-out coins and notes (see *Printable Resources* Term 3), if possible also an actual R10 and a R20 note to show learners.

DBE workbook activities relevant to this lesson:

- DBE Worksheet 107 (pp. 86 and 87).

Assessment: Refer to the tracker for today's formal/informal oral, practical or written assessment activity.

Remediation: Revise the value of the coins and notes with the learners: 5c, 10c, 20c, 50c, R1, R2, R5, R10, R20. Draw two five cent coins on the board. Ask: *How much money do I have?* (10c) Help the learners to write the number sentence ($5c + 5c = 10c$). Draw a five rand coin and a two rand coin on the board. Ask: *How much money do I have?* (R7) Help the learners to write the number sentence ($R5 + R2 = R7$).

Enrichment: See enrichment activity cards.

1. Mental mathematics

1.1 Counting (5 minutes)

- Count forwards and backwards in tens from any multiple between 0 and 100.
E.g. forwards 20, 30, 40...
backwards 90, 80, 70...

1.2 Mental mathematics activity (10 minutes)

	What is 2 more than	Answer
1.	9?	11
2.	5?	7
3.	8?	10
4.	12?	14
5.	15?	17

	What is 2 more than	Answer
6.	18?	20
7.	11?	13
8.	17?	19
9.	13?	15
10.	16?	18

2. Correction/reflection on homework (15 minutes)

Reflection/remediation based on previous day's work/homework.

3. Lesson content – concept development (30 minutes)

This lesson integrates teaching about money with the teaching of operations. As we no longer have a 5c coin in South Africa we do not need to teach learners what the 5c coin looks like. We have included examples with addition of 10c coins since the minimum requirement for Grade 1 is to add up to 20 in Term 4. If your learners are able to go beyond 20c in the context of money you should include other questions for them to do. The rands coins are useful for doing addition using money because the rand amounts on the coins are smaller (R2 and R5 fall well within the number range for Grade 1 addition and subtraction).

Activity 1: Whole class activity

- Draw simple pictures of the 10c, 20c, 50c, R1, R2 and R5 coins on the board.
- Discuss each coin with the learners. Ask learners to describe each coin (size, colour, edging, number symbols, flower/bird/animal, etc).
- Ask learners: *Which is more – R5 or 50c?* (R5)
- *Why do you say that?* (Cents are small amounts of money; rands are bigger amounts of money.)
- Remind the learners how to write each amount of money. (10c, 20c, 50c, R1, R2, R5)
- Call out an amount and ask the learners to write it down on their whiteboards/scrap paper.
E.g. Say: *Ten cents* – learners write 10c; *twenty cents* – learners write 20c; etc.

Activity 2: Whole class activity

- Show the learners an actual R10 note. Pass it around for everyone to look at.
- Discuss the note with the learners (colour, picture, number symbol, security features, etc).
- Show the learners how to write ten rand (R10) and encourage them to write **R10** down on their whiteboards/scrap paper.
- Introduce twenty rand in the same manner.
- Discuss this word problem with the class: *I go to the shop and buy a loaf of bread for R9. I pay with a R20/R10 note. How much change do I get?* (R11 or R1.)

Activity 3: Whole class activity

- Draw two 10c coins on the board.
- Ask: *How much money do you see?* (20c)
- Ask: *How did you work that out?* (I added the value of the two coins: $10c + 10c = 20c$.)
Encourage the learners to draw the money on their whiteboards/scrap paper and write down the number sentence.
- Draw a R2 coin and a R10 note on the board.
- Ask: *How much money do I have?* (R12).
- Ask: *How did you work that out?* (I added the value of the two coins: $R10 + R2 = R12$.) Encourage the learners to draw the money on their slates/whiteboards and write down the sum.

4. Classwork activity from LAB (25 minutes) (See next page)

5. Homework activity from LAB (5 minutes) (See next page)

6. Reflection on lesson

Term 4 Lesson 13: Addition and subtraction – money

Classwork

1. Add the following:

a) $10c + 10c + 10c = \square$ (30c)

b) $R1 + R2 + R5 = \square$ (R8)

2. Subtract the following:

a) $20c - 10c = \square$ (10c)

b) $R20 - R15 = \square$ (R5)

3. Solve the following:

a) Sam picked up 10c. He gets 10c pocket money and Granny gives him 10c. How much money does he have?

($10c + 10c + 10c = 30c$. He has 30c.)

b) Mohammed has 10c and he spends nothing. How much money does he have?

($10c - 0 = 10c$. He has 10c.)

Homework

1. Solve the following:

a) Sipho has R5, mom gives him R5 and granny gives him R5 more.

How much money does he have now? ($R5 + R5 + R5 = R15$. Sipho has R15 now.)

b) I have R15. I buy an ice-cream for R2 and a sweet for R3. How much change will I get?

($R15 - R2 - R3 = R10$. I get R10 change.)

LESSON 14: ADDITION AND SUBTRACTION – MONEY

Teacher's notes

CAPS topics: 1.2 Count forwards and backwards, 1.16 Mental mathematics, 1.6 Problem-solving techniques, 1.7 Addition and subtraction, 1.13 Addition and subtraction, 1.11 Money.

Lesson vocabulary: Forwards, backwards, addition, add, plus, more than, subtraction, minus, take away, less, equals, the same as, makes, money, change, coins, notes, value, rands, cents, operation, recognise, identify, total.

Prior knowledge: Learners should have been taught how to:

- Recognise, identify and read number symbols **0** to **80**.
- Count out objects reliably to 40.
- Solve word problems using various techniques and explain solutions to problems up to 20.
- Add and subtract up to 20.
- Recognise and identify South African coins.

Concepts:

- Recognise and identify South African coins 10c, 20c, 50c, R1, R2, R5; and bank notes R10, R20.
- Solve money problems involving totals and change to R20 and in cents up to 20c cents.

Resources: Cut-out coins and notes (see *Printable Resources* Term 3).

DBE workbook activities relevant to this lesson:

- DBE Worksheet 108 (pp. 88 and 89).

Assessment: Refer to the tracker for today's formal/informal oral, practical or written assessment activity.

Remediation: Solve the problems step-by-step with your learners. I have 10c. I bought a sweet for 10c. How much change did I get? Ask: *What is the question?* (How much change did I get?) *What are the numbers?* (10c and 10c.) *What basic operation will you use?* (Subtraction.) *What word asks you what basic operation to choose?* (Change.) *Show it with your money.* Help the learners to write the number sentence ($10c - 10c = 0$).

Enrichment: See enrichment activity cards.

1. Mental mathematics

1.1 Counting (5 minutes)

- Count forwards and backwards in tens from any multiple between 0 and 100.
E.g. forwards 50, 60, 70...
backwards 70, 60, 50...

1.2 Mental mathematics activity (10 minutes)

	What is 2 less than	Answer
1.	9?	7
2.	15?	13
3.	18?	16
4.	12?	10
5.	17?	15

	What is 2 less than	Answer
6.	16?	14
7.	11?	9
8.	14?	12
9.	20?	18
10.	19?	17

2. Correction/reflection on homework (15 minutes)

Reflection/remediation based on previous day's work/homework.

3. Lesson content – concept development (30 minutes)

Activity 1: Learners work in groups

- Give each group of learners some cut-out money (coins and notes).
- Ask the learners to show you 10c.
- Discuss the different coins used to make 20c.
(10c + 10c; 20c)
- Take away 10c. How did you do this?



- Show me R10. Take away R7. How did you do this?
(Discuss that one R10 note is the same as the following: a R5 coin, two R2 coins, and a R1 coin.)

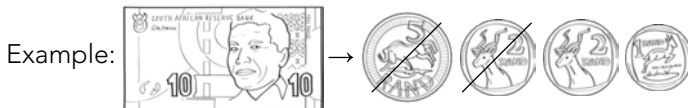

Activity 2: Whole class activity

- Solve the problems step-by-step with your learners.
- *I have R20. I bought sweets for R6. How much change did I get?*
- Ask: *What is the question?* (How much change did I get?)
- *What are the numbers?* (R20 and R6.)
- *What basic operation will you use?* (Subtraction.)
- *What word asks you what basic operation to choose?* (Change.)
- *Show it with your money.*



- Help the learners to write a number sentence. ($R20 - R6 = R14$)
- Another example: *I had 20c. I bought a toffee for 10c. What change did I get?* (10c)

4. Classwork activity from LAB (25 minutes) (See next page)

5. Homework activity from LAB (5 minutes) (See next page)

6. Reflection on lesson

Term 4 Lesson 14: Addition and subtraction – money

Classwork

1. How many different combinations can you draw for R20? We did the first one for you.

	(Multiple answers)
---	--------------------

2. Solve the following:

- Judy's birthday was on Sunday. She got R5 from her sister, R2 from her brother and R10 from her cousin. How much money did she get altogether? ($R5 + R2 + R10 = R17$)
- Rose's mom bought a scarf for R17. She paid with two R10 notes. How much change did she get? ($R20 - R17 = R3$)
- William bought a sweet for R11. He paid with a R10 note and a R5 coin. How much change did he get? ($R15 - R11 = R4$)

Homework

1. How many different combinations can you draw for R15? We did the first one for you.

	(Multiple answers)
---	--------------------

2. Solve the following:

John bought bread for R8. He paid for it with a R10 note. How much change did he get?
($R10 - R8 = R2$)

LESSON 15: 3-D OBJECTS – BALLS AND BOXES

Teacher's notes

CAPS topics: 1.2 Count forwards and backwards, 1.16 Mental mathematics, 3.2 3-D shapes.

Lesson vocabulary: Forwards, backwards, 3-D object, ball-shaped, box-shaped, roll, slide, flat surface, curved surface, bigger, recognise, describe, sort, compare.

Prior knowledge: Learners should have been taught how to:

- Recognise, identify and read number symbols **0** to **80**.
- Count out objects reliably to 40.
- Recognise and name 3-D objects in the classroom and in pictures in terms of: ball shapes (spheres); box shapes (prisms).
- Describe, sort and compare 3-D objects in term of: size; colour; objects that roll/slide.

Concepts:

- Recognise and name 3-D objects in the classroom and in pictures in terms of: ball shapes (spheres); box shapes (prisms).
- Describe, sort and compare 3-D objects in terms of: flat or curved surfaces; objects that can roll or slide.

Resources: Ball-shaped objects, box-shaped objects, pictures of ball-shaped and box-shaped objects (see *Printable Resources*).

DBE workbook activities relevant to this lesson:

- DBE Worksheet 106 (pp. 84 and 85).

Assessment: Refer to the tracker for today's formal/informal oral, practical or written assessment activity.

Remediation: Give the learners some ball-shaped objects and box-shaped objects. Discuss whether each object has a curved surface or a flat surface. Experiment on the ramp to see whether the objects can roll or slide or both. Say: *Objects which have round surfaces can roll and objects which have flat surfaces can slide and objects which have both round and flat surfaces can roll and slide.*

Enrichment: See enrichment activity cards.

1. Mental mathematics

1.1 Counting (5 minutes)

- Count forwards and backwards in fives from any multiple between 0 and 100.
E.g. forwards 40, 45, 50...
backwards 100, 95, 90...

1.2 Mental mathematics activity (10 minutes)

	Which number is bigger?	Answer
1.	16 or 10	16
2.	9 or 14	14
3.	15 or 11	15
4.	17 or 19	19
5.	19 or 7	19

	Which number is bigger?	Answer
6.	12 or 13	13
7.	20 or 19	20
8.	14 or 16	16
9.	18 or 8	18
10.	11 or 13	13

2. Correction/reflection on homework (15 minutes)

Reflection/remediation based on previous day's work/homework.

3. Lesson content – concept development (30 minutes)

There is one lesson this term on 3-D objects. Remember to collect as many different examples of ball- and box-shaped objects to bring to the lesson. It is very important for learners to work with real examples of 3-D objects while they are learning about them. In this lesson you consolidate learners' knowledge about the characteristics of ball- and box-shaped objects (slide/roll; curved/flat faces). In the first activity learners work with real objects while in the second activity they look at pictures of real objects. When they look at the pictures they draw on their experience with the real objects to visualize the real objects in the pictures.

Activity 1: Learners work in groups

- Give each group of learners some ball-shaped and box-shaped objects
- Ask the learners to sort the objects into two piles: ball-shaped objects and box-shaped objects.
- Walk around the classroom and identify any ball-shaped objects and box-shaped objects found in the classroom.
- Ask the learners the following questions:
 - *What does a ball look like?* (It is round.)
 - *What does a book look like?* (It looks like a box.)
 - *Can a ball slide?* (No)
 - *Can a box slide?* (Yes)
 - *Can a ball roll?* (Yes)
 - *Can a box roll?* (No)
- Discuss the difference between rolling and sliding and the types of objects that can roll/slide.
- Learners must build a small ramp by placing one end of a large book on top of another book. They can then experiment with the balls and boxes to determine whether the objects can slide or roll or both.
- Discuss: *Objects which have both round and flat surfaces can roll and slide.*
- Ask: *Do you know any shapes that have curved and flat faces?* (A cool drink can.)

Activity 2: Learners work in groups

- Give the learners pictures of boxes and balls.
- Ask the learners to look at a ball-shaped object.
- Ask: *Does the ball-shaped object have a flat or curved surface?* (Curved surface.)
- Ask the learners to look at a box-shaped object.
- Ask: *Does the box-shaped object have flat or curved surfaces?* (Flat surfaces.)
- Sort the pictures into three piles:
 - objects which have a curved surface;
 - objects which have flat surfaces;
 - objects which have both curved and flat surfaces.

4. Classwork activity from LAB (25 minutes) (See next page)

5. Homework activity from LAB (5 minutes) (See next page)

6. Reflection on lesson

Term 4 Lesson 15: 3-D objects – balls and boxes

Classwork

(Learners may draw the shapes in their books for this lesson if you do not have old newspapers/magazines for them to cut pictures from.)

(Learners answers will vary. Check their work to make sure they found the right kind of objects and followed the instructions correctly.)

1. Find two ball and two box pictures and paste them in your maths book. For example:



2. Colour all the objects that can slide **blue** and the objects that can roll **red**.

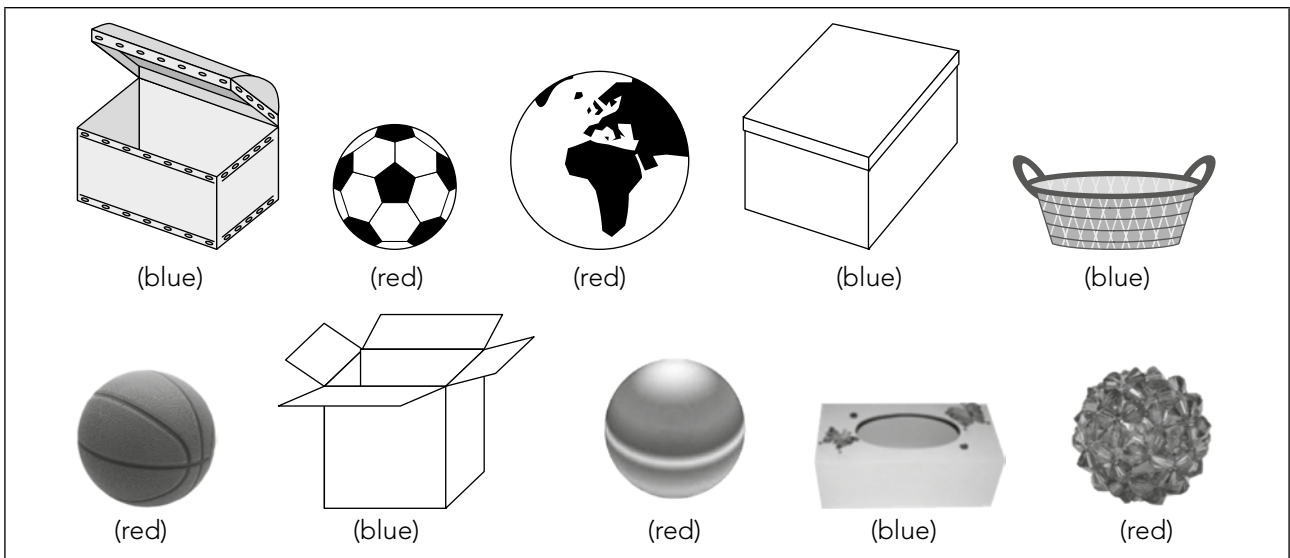

Homework

(Learners answers will vary. Check their work to make sure they found the right kind of objects and followed the instructions correctly.)

1. Find a ball-shaped object. Draw and label it.
2. Find a box-shaped object. Draw and label it.

WEEK 4

LESSON 16: POSITION AND VIEWS

Teacher's notes

CAPS topics: 1.2 Count forwards and backwards, 1.16 Mental mathematics, 3.1 Position, orientation and views.

Lesson vocabulary: Forwards, backwards, view, front, back, top, bottom, side, in front of, behind, next to, on top of, under, inside, below, beside, left, right, smaller, directions.

Prior knowledge: Learners should have been taught how to:

- Recognise, identify and read number symbols **0** to **80**.
- Apply the language of position learnt when following directions.
- Match different views of the same everyday object.

Concepts:

- Follow directions to move around the classroom.
- Follow instructions to place one object in relation to another, e.g. put the counter inside the box.
- Identify different views of the same everyday object.

Resources: Objects in the classroom, counters, empty boxes.

DBE workbook activities relevant to this lesson:

- DBE Worksheet 116 (pp. 104 and 105).

Assessment: Refer to the tracker for today's formal/informal oral, practical or written assessment activity.

Remediation: Ask the learners to do the following: Sit in front of, behind, on top of, on the left side of, on the right side of, under your desk. Assist where necessary by demonstrating it yourself. Give them a container and counters. Ask the learners to do the following: Put a counter in, under, beside, in front of, behind the container. Assist where necessary by demonstrating it yourself.

Enrichment: See enrichment activity cards.

1. Mental mathematics

1.1 Counting (5 minutes)

- Count forwards and backwards in fives from any multiple between 0 and 100.
E.g. forwards 60, 65, 70...
backwards 85, 80, 75...

1.2 Mental mathematics activity (10 minutes)

	Which number is smaller?	Answer
1.	16 or 12	12
2.	10 or 14	10
3.	15 or 11	11
4.	17 or 19	17
5.	19 or 13	13

	Which number is smaller?	Answer
6.	12 or 15	12
7.	20 or 19	19
8.	14 or 16	14
9.	18 or 8	8
10.	3 or 13	3

2. Correction/reflection on homework (15 minutes)

Reflection/remediation based on previous day's work/homework.

3. Lesson content – concept development (30 minutes)

In the next two lessons learners consolidate their understanding of position and direction. These topics help learners to develop their ability to visualise geometric (and other) shapes and objects. Remember to give time in this lesson to allow learners to sit and visualise. You should encourage them to close their eyes and 'look into the images they can see inside their heads' of the objects you are discussing. There is a lot of mathematical vocabulary related to positions and views. Refer to the Jika iMfundo dictionary if you need to for definitions and examples of the vocabulary used in this lesson.

Activity 1: Whole class activity

- Use a variety of classroom objects and ask the learners to show you the top, front and side views.
- Example: *Show me the top view/side view/front view of the table.*
- Etc. Use other real objects and discuss different views of the objects.

Activity 2: Whole class activity

- Ask one of the learners to stand in front of her/his desk.
- The rest of the class must say where the learner is standing, e.g. *She/he is standing in front of the desk.*
- Do the same with: behind, on top of, left, right, under.
- Ask all the learners to do the following:
 - *Sit in front of your desk.*
 - *Sit behind your desk.*
 - *Sit on top of your desk.*
 - *Sit on the left side of your desk.*
 - *Sit on the right side of your desk.*
 - *Sit under your desk.*

Activity 3: Learners work in groups

- Give each group of learners a container, e.g. their empty lunch boxes and counters.
- Say:
 - *Put a counter in the box.*
 - *Put a counter under the box.*
 - *Put a counter on top of the box.*
 - *Put a counter on the left side of the box.*
 - *Put a counter on the right side of the box.*
 - *Put a counter in front of the box.*
 - *Put a counter behind the box.*

4. Classwork activity from LAB (25 minutes) (See next page)



5. Homework activity from LAB (5 minutes) (See next page)

6. Reflection on lesson



Term 4 Lesson 16: Position and views

Classwork

1. Name the following views:

		
top view	top view	(back view)
(front view)	front view	front view
side view	(side view)	side view

2. Where is the ball?

		
behind	behind	(behind)
(next to)	next to	next to
in front of	(in front of)	in front of

3. Complete the following:

- Draw a square.
- Draw a circle inside the square.
- Draw a cross above the square.
- Draw a triangle below the square.
- Write your name on the left side of the square.

Answer:

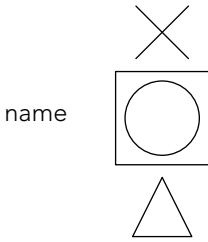

Homework

Complete the following:

- Draw a triangle.
- Draw a square on the left of the triangle.
- Draw a circle below the triangle.
- Draw a heart above the triangle.
- Write your name on the right of the triangle.

Answer:

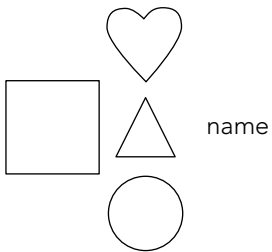

LESSON 17: POSITION AND VIEWS

Teacher's notes

CAPS topics: 1.2 Count forwards and backwards, 1.16 Mental mathematics, 3.1 Position, orientation and views.

Lesson vocabulary: Forwards, backwards, view, front, back, top, bottom, side, in front of, behind, next to, on top of, under, inside, below, beside, left, right, middle, above, more than, smaller, bigger.

Prior knowledge: Learners should have been taught how to:

- Recognise, identify and read number symbols **0** to **80**.
- Apply the language of position learnt when following directions.
- Match different views of the same everyday object.

Concepts:

- Follow directions to move around the classroom.
- Follow instructions to place one object in relation to another, e.g. put the counter inside the box.
- Identify different views of the same everyday object.

Resources: None today.

DBE workbook activities relevant to this lesson:

- N/A

Assessment: Refer to the tracker for today's formal/informal oral, practical or written assessment activity.

Remediation: Ask the learners to do the following: *Turn and show the side view of yourself, the front view of yourself and the back view of yourself.* Then ask each learner to work with a partner and show his/her front, back and side views.

Enrichment: See enrichment activity cards.

1. Mental mathematics

1.1 Counting (5 minutes)

- Count forwards and backwards in fives from any multiple between 0 and 100.
E.g. forwards 40, 45, 50...
backwards 95, 90, 85...

1.2 Mental mathematics activity (10 minutes)

	Complete the following:	Answer
1.	What is 2 less than 9?	7
2.	What is 2 more than 17?	19
3.	Which is smaller: 17 or 13?	13
4.	Which is bigger: 5 or 15?	15
5.	Add: $7 + 1 = \underline{\quad}$	8

	Complete the following:	Answer
6.	What is 2 less than 15?	13
7.	What is 2 more than 9?	11
8.	Which is smaller: 9 or 12?	9
9.	Which is bigger: 10 or 20?	20
10.	Add: $2 + 3 = \underline{\quad}$	5

2. Correction/reflection on homework (15 minutes)

Reflection/remediation based on previous day's work/homework.

3. Lesson content – concept development (30 minutes)

Activity 1: Learners work in groups

- Take learners outside.
- Ask one learner at a time to stand in front of each group.
- Ask the learner to turn and show the *side* view of her/himself, the *front* view of her/himself and the *back* view of her/himself.
- Learners can also work in pairs and demonstrate different views to each other.

Activity 2: Whole class activity

- Choose two learners who are the same height. Ask them to stand next to each other.
- Point out to the learners that they are the same height.
- Ask one of the learners to go stand on the other side of the field.
- Ask: *Do they still look the same height?* (No)
- *Are they actually still the same height?* (Yes)
- *So, why does the person on the other side of the field the class look smaller now?*
(Because s/he is further away.)
- Repeat with other learners but vary the distances between them so that learners begin to understand that objects look different when one looks at them from different positions. Learners may take it for granted that objects such as cars look small when they are far away.
- Learners can also experiment with placing their hand in front of them, to block their view of larger objects that are further away.

4. Classwork activity from LAB (25 minutes) (See next page)

5. Homework activity from LAB (5 minutes) (See next page)

6. Reflection on lesson

Term 4 Lesson 17: Position and views

Classwork

(Learners answers will vary. Check their work to make sure they drew the pictures in the correct positions according to the instructions.)

1. Draw a tree in the middle of your page.
2. Draw two large clouds above the tree.
3. Draw a sun on the right side of the clouds.
4. Draw a child sitting on the right side of the tree.
5. Draw a dog on the left side of the tree.
6. Draw flowers in front of the tree.
7. Draw grass below the tree.
8. Colour in your picture.

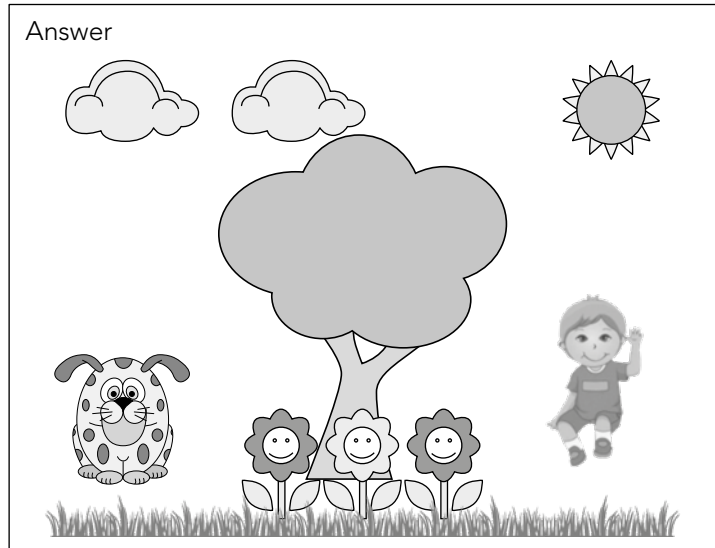

Homework

1. Draw pictures to match the sentences:

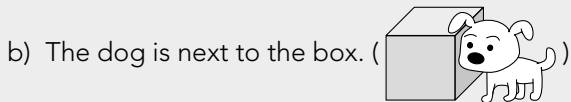
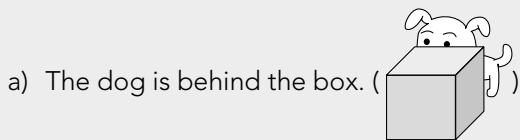

LESSON 18: MASS

Teacher's notes

CAPS topics: 1.1 Count objects, 1.2 Count forwards and backwards, 1.16 Mental mathematics, 4.3 Mass.

Lesson vocabulary: Forwards, backwards, heavy, light, heavier, lighter, heaviest, lightest, balance, more than, estimate, measure, compare, record, mass, balancing scale, non-standard measure.

Prior knowledge: Learners should have been taught how to:

- Recognise, identify and read number symbols **0** to **80**.
- Estimate, measure, compare, order and record mass using a balancing scale and non-standard measures, e.g. blocks, bricks, etc.
- Use language to talk about the comparison, e.g. light, heavy, lighter, heavier.

Concepts:

- Estimate, measure, compare, order and record mass using a balancing scale and non-standard measures, e.g. blocks, bricks, etc.
- Use language to talk about the comparison, e.g. light, heavy, lighter, heavier.

Resources: Blocks, balance scales.

DBE workbook activities relevant to this lesson:

- DBE Worksheet 121 (pp. 114 and 115).

Assessment: Refer to the tracker for today's formal/informal oral, practical or written assessment activity.

Remediation: Give the learners two objects to hold and then ask them to ask you which one is heavier/lighter. The learners check their answer by placing each object on the balance scale to find out its mass using the blocks.

Enrichment: See enrichment activity cards.

1. Mental mathematics

1.1 Counting (5 minutes)

- Count forwards and backwards in twos from any multiple between 0 and 100.
E.g. forwards 42, 44, 46...
backwards 100, 98, 96...

1.2 Mental mathematics activity (10 minutes)

	Which number is 3 more than...	Answer
1.	8?	11
2.	12?	15
3.	9?	12
4.	11?	14
5.	10?	13

	Which number is 3 more than...	Answer
6.	13?	16
7.	16?	19
8.	14?	17
9.	17?	20
10.	15?	18

2. Correction/reflection on homework (15 minutes)

Reflection/remediation based on previous day's work/homework.

3. Lesson content – concept development (30 minutes)

There are two lessons on the topic of mass this term. Learners need to consolidate their understanding of the concept and knowledge of the terminology related to the concept of mass. Remember to refer to the lesson vocabulary list (and Jika IMfundo dictionary) to recap the terminology relevant to the lesson. You need a balance scale in this lesson – one per group or one to use for demonstrating.

Activity 1: Whole class activity

- Discuss with the class that mass refers to the amount of substance an object is made of. Use examples to help them realise the difference between the mass of different objects.
- Give each group of learners two objects to hold, one in each hand.
- Ask:
 - Which object is heavier?
 - Which object is lighter?
- Place them on the balance scale to check if you were correct (in front of the class or in groups).
- Discuss: *When an object is lighter, what can we say about its mass?* (It has a lower mass – it is made of less substance.)
- Discuss: *When an object is heavier, what can we say about its mass?* (It has a higher mass – it is made of more substance.)

Activity 2: Learners work in groups

- Give each group of learners 20 blocks and a balance scale. (Do this activity as a whole class demonstration if you do not have more than one balance scale.)
- Ask learners to place the 20 blocks in the one bucket and to then find three objects that each weigh the same as the blocks.
- Ask learners to measure a variety of items, using the blocks as an arbitrary unit of measurement.
- Learners must state the unit when giving the mass, e.g. the book has the same mass as 15 blocks.
- Do the same with a ruler, pencil, eraser, etc.

Activity 3: Learners work in groups

- Give each group 20 blocks, 20 counters and a balance scale. (Do this activity as a whole class demonstration if you do not have more than one balance scale.)
- Ask the learners: *Use your blocks to measure the mass of a pencil.*
- Ask the learners: *Use your counters to measure the mass of the same pencil.*
- Ask learners: *What do you notice?* (We got a different number of blocks and counters.)
- Learners need to understand that in order to compare the mass of different objects, the same unit needs to be used.
- For example, if a ruler has a mass of 20 blocks and a pair of scissors has the mass of 20 marbles, one cannot say whether they have the same mass or not.
- Discuss why we can't compare mass if we have used different non-standard units. (Because the units are not exactly the same.)

4. Classwork activity from LAB (25 minutes) (See next page)

5. Homework activity from LAB (5 minutes) (See next page)

6. Reflection on lesson

Term 4 Lesson 18: Mass

Classwork

1. How many blocks are there on each side of the scale? For each pair:
- Which container is heavier?
 - Which container is lighter?

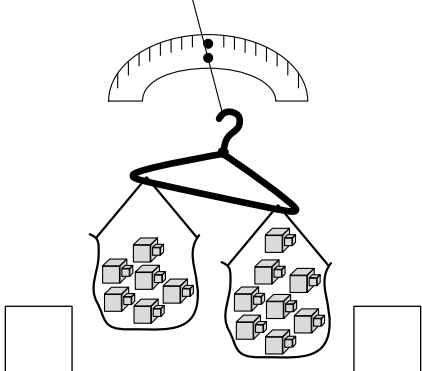
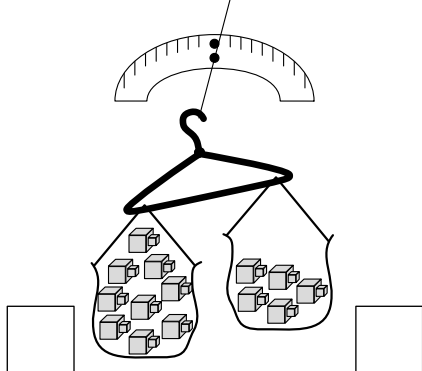
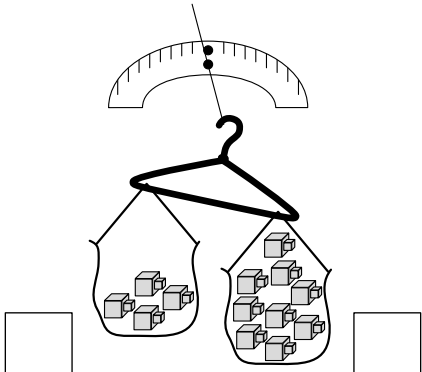
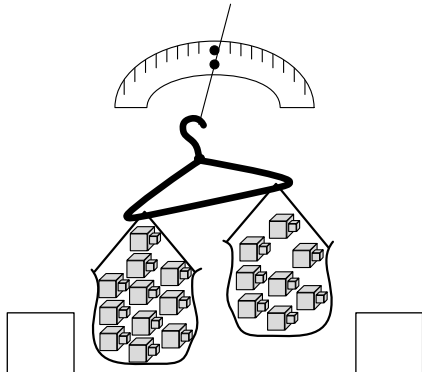
 <p>Scale 1 (6) blocks (lighter) (8) blocks (heavier)</p>	 <p>Scale 2 (9) blocks (heavier) (5) blocks (lighter)</p>
 <p>Scale 3 (4) blocks (lighter) (9) blocks (heavier)</p>	 <p>Scale 4 (11) blocks (heavier) (8) blocks (lighter)</p>

Homework

(Learners answers will vary. Check their work to make sure that the objects have been compared correctly according to mass.)

- Choose four objects from around your home.
- Write the names of the four objects you chose.
- Estimate which is the heaviest object. Draw it in your homework book.
- Estimate which is the lightest object. Draw it in your homework book.

LESSON 19: MASS

Teacher's notes

CAPS topics: 1.2 Count forwards and backwards, 1.16 Mental mathematics, 4.3 Mass.

Lesson vocabulary: Forwards, backwards, mass, heavy, light, heavier, lighter, heaviest, lightest, balance, measure, compare, less than, balancing scale, non-standard measure, equal, order, record, greater.

Prior knowledge: Learners should have been taught how to:

- Recognise, identify and read number symbols **0** to **80**.
- Estimate, measure, compare, order and record mass using a balancing scale and non-standard measures, e.g. blocks, bricks, etc.
- Use language to talk about the comparison in mass, e.g. light, heavy, lighter, heavier.

Concepts:

- Estimate, measure, compare, order and record mass using a balancing scale and non-standard measures, e.g. blocks, bricks, etc.
- Use language to talk about the comparison of mass, e.g. light, heavy, lighter, heavier.

Resources: Whiteboards/scrap paper, blocks, objects in the classroom, balance scales.

DBE workbook activities relevant to this lesson:

- N/A

Assessment: Refer to the tracker for today's formal/informal oral, practical or written assessment activity.

Remediation: Give learners 10 blocks and a balance scale. Give the learners an object to compare mass. Note that the object should have a mass between 1 and 10 blocks. Ask the learners to give feedback such as: *The eraser has the same mass as 5 blocks.* Ask the learners to find everyday objects that have a mass of between 5 blocks and 10 blocks.

Enrichment: See enrichment activity cards.

1. Mental mathematics

1.1 Counting (5 minutes)

- Count forwards and backwards in twos from any multiple between 0 and 100.
E.g. forwards 36, 38, 40...
backwards 86, 84, 82...

1.2 Mental mathematics activity (10 minutes) (Learners may use a number line)

	Which number is 3 less than...	Answer
1.	9?	6
2.	12?	9
3.	10?	7
4.	11?	8
5.	15?	12

	Which number is 3 less than...	Answer
6.	13?	10
7.	16?	13
8.	14?	11
9.	17?	14
10.	20?	17

2. Correction/reflection on homework (15 minutes)

Reflection/remediation based on previous day's work/homework.

3. Lesson content – concept development (30 minutes)

Activity 1: Learners to work in groups

- Give each group of learners 30 blocks and a balance scale. (Do this activity as a whole class demonstration if you do not have more than one balance scale.)
- Give the learners an object per group to compare mass.
- Note that the object should have a mass of between 20 and 30 blocks.
- Ask the learners to give feedback such as: *The book has the same mass as 25 blocks.*
- Ask the learners to find everyday objects that have a mass of: 5 blocks, 10 blocks, and 15 blocks.

Activity 2: Whole class activity

- Ask the learners to draw the following on their slates:
 - A balance scale that shows two objects that have the same mass.
- Ask them to point to the picture and say:
 - *The objects have the same mass. They are equal in mass.*
 - *How do we know when the mass is the same?* (There are the same number of blocks on both sides of the balance scale.)
- Ask the learners to draw the following on their whiteboards/scrap paper:
 - A balance scale that shows two objects that have different masses.
- Ask them to point to the picture and say:
 - *The objects do not have the same mass. They are different in mass.*
 - *How do we know when the mass is different?*
(There are a different number of blocks on each side of the balance.)

4. Classwork activity from LAB (25 minutes) (See next page)

5. Homework activity from LAB (5 minutes) (See next page)

6. Reflection on lesson

Term 4 Lesson 19: Mass

Classwork

1. Choose an object in your class which you think is heavier than you. Draw it.
(Learners answers will vary. Check that they have chosen appropriate objects.)
2. Choose an object in your class which you think is lighter than you. Draw it.
(Learners answers will vary. Check that they have chosen appropriate objects.)
3. Which has a greater mass? The pile on the right or the pile on the left?

a)

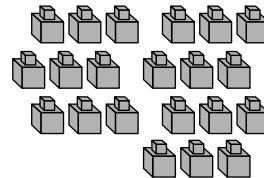
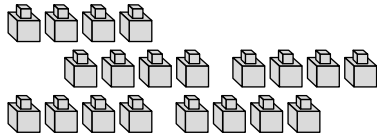

(left has greater mass – there are 20 blocks on the left and 21 blocks on the right)

b)

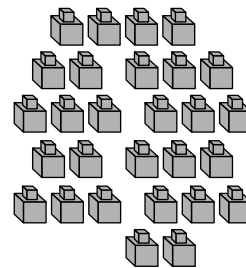
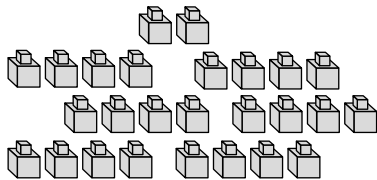

(right has greater mass – there are 26 blocks on the left and 28 blocks on the right)

c)

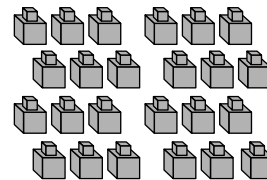
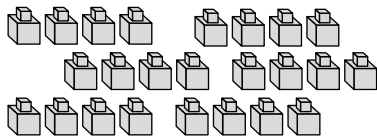

(equal mass – there are 24 blocks on the left and 24 blocks on the right)

4. Write which bag of blocks would be heavier/lighter. The first one is done for you.
 - a) 21 blocks (lighter) and 27 blocks (heavier).
 - b) 24 blocks ___ and 22 blocks _____. (heavier, lighter)
 - c) 30 blocks ___ and 20 blocks _____. (heavier, lighter)
 - d) 26 blocks ___ and 28 blocks _____. (lighter, heavier)
 - e) 23 blocks ___ and 29 blocks _____. (lighter, heavier)

Homework

(Learners answers will vary. Check that they have chosen appropriate objects according to the instructions in the questions.)

1. Choose an object at your home which you think is heavier than you. Draw it.
2. Choose an object at your home which you think is lighter than you. Draw it.

LESSON 20: NUMBER PATTERNS – 2s, 5s AND 10s TO 100

Teacher's notes

CAPS topics: 1.1 Count objects, 1.2 Count forwards and backwards, 1.16 Mental mathematics, 2.2 Number patterns.

Lesson vocabulary: How many, groups, fives, twos, tens, forwards, backwards, add, multiple, even number, odd number, number pattern, describe (number patterns).

Prior knowledge: Learners should have been taught how to:

- Recognise, identify and read number symbols **0** to **80**.
- Copy, extend and describe simple number sequences to at least 80.
- Count forwards in 5s, 2s and 10s between 0 and 80.
- Create and describe own number patterns.

Concepts:

- Counting forwards in 5s, 10s and 2s from any multiple between 0 and 100.
- Create and describe own number patterns.

Resources: 1–100 number board (see *Printable Resources*), 0–20 number lines (see *Printable Resources*), counters.

DBE workbook activities relevant to this lesson:

- DBE Worksheet 115 (pp. 102 and 103).

Assessment: Refer to the tracker for today's formal/informal oral, practical or written assessment activity.

Remediation: Give the learners a 1–100 number board and assist them with placing counters on all the fives starting at 5. As they place the counter on the numbers, they read the numbers. Do the same with counting in ones (if necessary), twos and tens.

Enrichment: See enrichment activity cards.

1. Mental mathematics

1.1 Counting (5 minutes)

- Count forwards and backwards in tens from any multiple between 0 and 100.
E.g. forwards 30, 40, 50...
backwards 100, 90, 80...

1.2 Mental mathematics activity (10 minutes)

	Add the following:	Answer
1.	$6 + 2 = \underline{\quad}$	8
2.	$9 + 1 = \underline{\quad}$	10
3.	$7 + 2 = \underline{\quad}$	9
4.	$1 + 5 = \underline{\quad}$	6
5.	$8 + 2 = \underline{\quad}$	10

	Add the following:	Answer
6.	$3 + 3 = \underline{\quad}$	6
7.	$6 + 1 = \underline{\quad}$	7
8.	$2 + 0 = \underline{\quad}$	2
9.	$4 + 1 = \underline{\quad}$	5
10.	$1 + 7 = \underline{\quad}$	8

2. Correction/reflection on homework (15 minutes)

Reflection/remediation based on previous day's work/homework.

3. Lesson content – concept development (30 minutes)

This is the first of two lessons on number patterns this term. In this lesson you revise the number patterns of 10s, 5s and 2s – counting in these patterns up to 100. Connections are made between counting patterns and multiples – to further consolidate learners' concept of multiples. The questions linking the counts to multiples are repeated – this is important as it will help learners establish their mathematical vocabulary.

Activity 1: Learners work in groups

- Give each group of learners a 1–100 number board.
- Ask them to place counters on 5, 10, 15 ... 100 and then count in fives.
- Ask learners: *What do you notice about the numbers?* (They all end in zero or five.)
- Ask: *What can we say about the multiples of 5?* (They either end in a 5 or a 0.)
- Ask them to place counters on 2, 4, 6 ... 90 and then count in twos.
- Ask learners: *What do you notice about the numbers?* (They all end in even numbers.)
- Ask: *What can we say about the multiples of 2?* (They either end in an even number or a 0.)
- Ask them to place counters on 10, 20, 30 ... 100 and then count in tens.
- Ask learners: *What do you notice about the numbers?* (They all end in a zero.)
- Ask: *What can we say about the multiples of 10?* (They either end in a 0.)

Activity 2: Learners work in groups

- Give each group of learners a 0–20 number line.
- Say: *First we will look at patterns of five on the number line.*
- Ask them to place their finger on 0 and then make a jump from 0 to 5, then from 5 to 10 and so on in fives until they get to 20.
- The learners count in fives as they make the jumps with their fingers.
- Ask learners: *What do you notice about the numbers?* (They all end in zero or five.)
- *What number comes after 20 when we count in 5s?* (25)
- Ask: *What can we say about the multiples of 5?* (They either end in a 5 or a 0.)
- Say: *Now we will look at patterns of two on the number line.*
- Ask them to place their finger on 0 and then make a jump from 0 to 2, then from 2 to 4 and so on in twos until they get to 20.
- The learners count in twos as they make the jumps with their fingers.
- Ask learners: *What do you notice about the numbers?* (They all end in even numbers.)
- *What number comes after 20 when we count in 2s?* (22)
- Ask: *What can we say about the multiples of 2?* (They either end in an even number or a 0.)
- Say: *Now we will look at patterns of ten on the number line.*
- Ask them to place their finger on 0 and then make a jump from 0 to 10, then from 10 to 20.
- The learners count in tens as they make the jumps with their fingers.
- Ask learners: *What do you notice about the numbers?* (They all end in a zero.)
- *What number comes after 20 when we count in 10s?* (30)
- Ask: *What can we say about the multiples of 10?* (They end in a zero.)

4. Classwork activity from LAB (25 minutes) (See next page)

5. Homework activity from LAB (5 minutes) (See next page)

6. Reflection on lesson

Term 4 Lesson 20: Number patterns – 2s, 5s and 10s to 100

Classwork

1. Colour all the fives red. Start at 5. Circle all the twos with a blue crayon. Start at 2.
Put a star next to all the tens.

1	(2)	3	(4)	(5)	(6)	7	(8)	9	(10)*
11	(12)	13	(14)	(15)	(16)	17	(18)	19	(20)*
21	(22)	23	(24)	(25)	(26)	27	(28)	29	(30)*
31	(32)	33	(34)	(35)	(36)	37	(38)	39	(40)*
41	(42)	43	(44)	(45)	(46)	47	(48)	49	(50)*
51	(52)	53	(54)	(55)	(56)	57	(58)	59	(60)*
61	(62)	63	(64)	(65)	(66)	67	(68)	69	(70)*
71	(72)	73	(74)	(75)	(76)	77	(78)	79	(80)*
81	(82)	83	(84)	(85)	(86)	87	(88)	89	(90)*
91	(92)	93	(94)	(95)	(96)	97	(98)	99	(100)*

2. Complete the pattern by colouring in the multiples of 5.

31	32	33	34	35	36	37	38	39	40
41	42	43	44	(45)	46	47	48	49	(50)

3. Complete the pattern by colouring in the even numbers.

61	62	63	64	65	66	67	(68)	69	(70)
71	(72)	73	(74)	75	(76)	77	(78)	79	(80)

Homework

1. Complete the pattern by colouring in the even numbers.

1	2	3	4	5	(6)	7	(8)	9	(10)
11	(12)	13	(14)	15	(16)	17	(18)	19	(20)

2. Complete the pattern by colouring in the multiples of 5.

1	2	3	4	5	6	7	8	9	10
11	12	13	14	(15)	16	17	18	19	(20)

WEEK 5

LESSON 21: NUMBER PATTERNS – 2s, 5s AND 10s TO 100

Teacher's notes

CAPS topics: 1.1 Count objects, 1.2 Count forwards and backwards, 1.16 Mental mathematics, 2.2 Number patterns.

Lesson vocabulary: Forwards, backwards, how many, groups, fives, twos, forwards, backwards, copy, extend, describe (patterns), number sentence, number pattern, subtract, multiple, smallest, largest, biggest, after, before, even number.

Prior knowledge: Learners should have been taught how to:

- Recognise, identify and read number symbols **0** to **80**.
- Copy, extend and describe simple number sequences to at least 80.
- Count forwards in 5s, 2s and 10s between 0 and 80.
- Create and describe own number patterns

Concepts:

- Copy, extend and describe simple number sequences to at least 100.
- Counting forwards in 5s, 2s and 10s between 0 and 100.
- Create and describe own number patterns.

Resources: 5x table number cards, 2x table number cards, 10x table number cards (see *Printable Resources*).

DBE workbook activities relevant to this lesson:

- DBE Worksheet 119 (pp. 110 and 111), DBE Worksheet 120 (pp. 112 and 113).

Assessment: Refer to the tracker for today's formal/informal oral, practical or written assessment activity.

Remediation: Give the learners number cards 5–100 and a number board. Ask them to use the number board to help them place the number cards in order starting at 5. Then give the learners number cards 2–100 and a number board. Ask them to use the number board to help them place the number cards in order starting at 2. Discuss the patterns of 2 and 5. Are there any numbers that are in both patterns?

Enrichment: See enrichment activity cards.

1. Mental mathematics

1.1 Counting (5 minutes)

- Count forwards and backwards in twos from any multiple between 0 and 100.
E.g. forwards 52, 54, 56...
backwards 100, 98, 96...

1.2 Mental mathematics activity (10 minutes)

	Subtract the following:	Answer
1.	$8 - 2 = \underline{\quad}$	6
2.	$10 - 1 = \underline{\quad}$	9
3.	$3 - 2 = \underline{\quad}$	1
4.	$9 - 5 = \underline{\quad}$	4
5.	$7 - 6 = \underline{\quad}$	1

	Subtract the following:	Answer
6.	$9 - 8 = \underline{\quad}$	1
7.	$6 - 4 = \underline{\quad}$	2
8.	$5 - 5 = \underline{\quad}$	0
9.	$8 - 3 = \underline{\quad}$	5
10.	$7 - 1 = \underline{\quad}$	6

2. Correction/reflection on homework (15 minutes)

Reflection/remediation based on previous day's work/homework.

3. Lesson content – concept development (30 minutes)

In this lesson learners must sort number cards (with multiplies of 2, 5 and 10) in ascending (smallest to biggest) and descending (biggest to smallest) order. Learners don't have to know the terms ascending and descending but sorting in terms of order is a very good activity for learners to consolidate number patterns and multiples. The three lesson activities give time for learners to work with each of the three sets of multiples.

Activity 1: Learners work in groups

- Place the number cards 5–100 (5x table) randomly on the learners' desks. Ask the learners to place them in order starting with the smallest number.
(5, 10, 15, 20, 25, 30, 35, 40, 45, 50, 55, 60, 65, 70, 75, 80, 85, 90, 95, 100)
- Shuffle the number cards and spread them out on the desks again. Ask the learners to place them in order starting with the biggest number.
- Ask the learners questions such as:
 - What comes after 25 when you count in 5s? (30)
 - *What comes after 80 when you count in 5s?* (85)
 - What comes before 20 when you count in 5s? (15)
 - *What comes before 50 when you count in 5s?* (45)

Activity 2: Learners work in groups

- Place the number cards 2–90 (2x table) randomly on the learners' desks.
- Ask the learners to place them in order starting with the smallest number.
(2, 4, 6, 8, 10, 12, 14, 16, 18, 20, 22, 24, 26, 28, 30, 32, 34, 36, 38, 40, 42, 44, 46, 48, 50, 52, 54, 56, 58, 60, 62, 64, 66, 68, 70, 72, 74, 76, 78, 80, 82, 84, 86, 88, 90)
- Shuffle the number cards and spread them out on the desks again. Ask the learners to place them in order starting with the biggest number.
- Ask the learners questions such as:
 - *What comes after 40 when you count in 2s?* (42)
 - *What comes before 60 when you count in 2s?* (58)
 - Ask more questions if there is time.

Activity 3: Learners work in groups

- Place the number cards 10–100 (10x table) randomly on the learners' desks.
- Ask the learners to place them in order starting with the smallest number.
(10, 20, 30, 40, 50, 60, 70, 80, 90, 100)
- Shuffle the number cards and spread them out on the desks again. Ask the learners to place them in order starting with the biggest number.
- Ask the learners questions such as:
 - *What comes after 30 when you count in 10s?* (40)
 - *What comes before 90 when you count in 10s?* (80)
 - Ask more questions if there is time.

4. Classwork activity from LAB (25 minutes) (See next page)

5. Homework activity from LAB (5 minutes) (See next page)

6. Reflection on lesson

Term 4 Lesson 21: Number patterns – 2s, 5s and 10s to 100

Classwork

1. Complete the labels on the number lines using the given numbers:

64	70	35	90	60	15	80
100	30	20	66	62	25	68

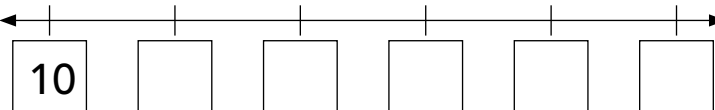
a) Count in 5s:  (10, 15, 20, 25, 30, 35)

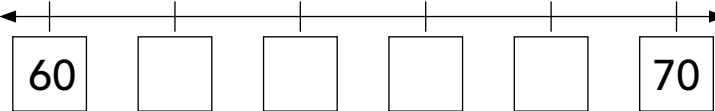
b) Count in 2s:  (60, 62, 64, 66, 68, 70)

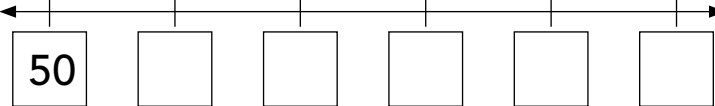
c) Count in 10s:  (50, 60, 70, 80, 90, 100)

2. Draw hops on a number line to show:

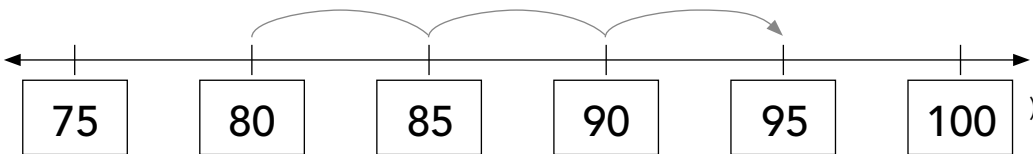
a) 85, 90, 95 ()

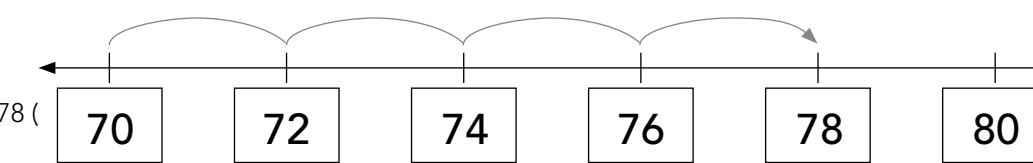
b) 72, 74, 76, 78 ()

Homework

1. Complete the pattern by colouring in the even numbers.

41	42	43	44	45	(46)	47	(48)	49	(50)
51	(52)	53	(54)	55	(56)	57	(58)	59	(60)

2. Complete the pattern by colouring in the multiples of 5.

81	82	83	84	85	86	87	88	89	90
91	92	93	94	(95)	96	97	98	99	(100)

LESSON 22: 5s AND 2s – REPEATED ADDITION UP TO 20

Teacher's notes

CAPS topics: 1.1 Count objects, 1.2 Count forwards and backwards, 1.16 Mental mathematics, 1.12 Techniques (methods or strategies), 1.14 Repeated addition leading to multiplication.

Lesson vocabulary: Forwards, backwards, groups of, add, equals, repeated addition, less than, more than, subtract, calculation, number sentence, plus, equals, symbol.

Prior knowledge: Learners should have been taught how to:

- Recognise, identify and read number symbols **0** to **80**.
- Use the following techniques when performing calculations: Concrete apparatus, drawings, building up and breaking down numbers, doubling and halving, number lines.
- Repeated addition in the range 0–15.

Concepts:

- Repeated addition in the range 0–20.
- Use the following techniques when performing calculations: concrete apparatus and drawings.

Resources: Whiteboards/scrap paper, counters.

DBE workbook activities relevant to this lesson:

- DBE Worksheet 113 (pp. 98 and 99).

Assessment: Refer to the tracker for today's formal/informal oral, practical or written assessment activity.

Remediation: Draw the following on the board: ○○○○○ ○○○○○ ○○○○○

Help the learners to write the number sentence $(5 + 5 + 5 = 15)$.

Draw the following on the board: ○○ ○○ ○○

Help the learners to write the number sentence $(2 + 2 + 2 = 6)$.

Do the same with 4 groups of 5, and 6 groups of 2.

Enrichment: See enrichment activity cards.

1. Mental mathematics

1.1 Counting (5 minutes)

- Count forwards and backwards in twos from any multiple between 0 and 100.
E.g. forwards 52, 54, 56...
backwards 100, 98, 96...

1.2 Mental mathematics activity (10 minutes)

	Complete the following:	Answer
1.	What is 3 less than 7?	4
2.	What is 3 more than 15?	18
3.	What is 3 less than 5?	2
4.	Add: $4 + 6 = \underline{\quad}$	10
5.	Subtract: $10 - 9 = \underline{\quad}$	1

	Complete the following:	Answer
6.	What is 3 less than 19?	16
7.	What is 3 more than 10?	13
8.	What is 3 more than 14?	17
9.	Add: $7 + 2 = \underline{\quad}$	9
10.	Subtract: $8 - 3 = \underline{\quad}$	5

2. Correction/reflection on homework (15 minutes)

Reflection/remediation based on previous day's work/homework.

3. Lesson content – concept development (30 minutes)

This is the first of two final lessons in Grade 1 on repeated addition leading to multiplication. In Grade 1 learners do not have to learn the multiplication sign (they record their working using repeated addition only) but it is important that they become aware of problems involving repeated addition. The adding of repeated groups of the same amount prepares them for the concept of multiplication.

The important idea to stress in these two lessons is that we can add several groups of (or lots of) a certain number. This is done by linking the addition to real objects that embody groups/lots of different numbers. These lessons revise and consolidate addition.

Activity 1: Learners work in groups

- Give each group of learners counters and their whiteboards/scrap paper.
- In this activity learners work with counters in groups and write number sentences on the board.
- Ask the learners to show you: $5 + 5 = 10$ using counters (○○○○○ ○○○○○)
We can say: *5 plus 5 equals 10.*
 - Do the same with $5 + 5 + 5 = 15$ and
 - $5 + 5 + 5 + 5 = 20$
- Ask learners to volunteer to come to the board and write the repeated addition number sentences on the board. They should first write the number sentence and then read it out to the class.
- Discuss the nature of the number sentences (repeated groups being added) and ways in which counting using the multiples of 5 can help learners calculate the answers.
- Ask the learners to show you: $2 + 2 = 4$ using counters (○○ ○○)
We can say: *2 plus 2 equals 4.*
 - Do the same with $2 + 2 + 2 + 2 + 2 + 2 = 14$ and
 - $2 + 2 + 2 + 2 + 2 + 2 + 2 = 16$
- Once again ask learners to volunteer to come to the board and write the repeated addition number sentences on the board, read what they have written and explain how they would calculate the answer using multiples of 2.

Activity 2: Learners work in groups

- In this activity learners work on their whiteboards/scrap paper.
- Ask the learners to use their whiteboards/scrap paper to draw 2 groups of 5. (They can make a similar display on their desks using counters at the same time, or they could just do the drawing).
- Ask them to draw a circle around each group.
- Then ask them to write the number sentence ($5 + 5 = 10$).
- Do the same with 3, 4 and 5 groups of 5.
- Ask the learners to use their whiteboards/scrap paper to draw 2 groups of 2.
- Ask them to draw a circle around each group.
- Then ask them to write the number sentence ($2 + 2 = 4$).
- Do the same with 7, 8, 9 and 10 groups of 2.

4. Classwork activity from LAB (25 minutes) (See next page)



5. Homework activity from LAB (5 minutes) (See next page)

6. Reflection on lesson

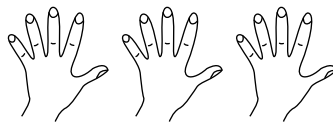
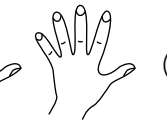

Term 4 Lesson 22: 5s and 2s – repeated addition to 20

Classwork

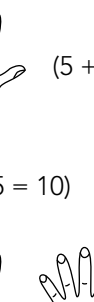
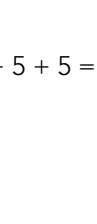

1. How many fingers are there? Write a number sentence for it.

- a)  (5 + 5 + 5 = 15)
- b)  (5 + 5 = 10)
- c)  (5 + 5 + 5 + 5 = 20)

2. How many legs are there? Write a number sentence for it.

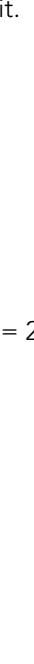

- a)  (2 + 2 + 2 + 2 = 8)
- b)  (2 + 2 + 2 = 6)
- c)  (2 + 2 + 2 + 2 + 2 + 2 = 12)

3. Write number sentences for the following:

- a)  (5 + 5 = 10)
- b)  (5 + 5 + 5 + 5 = 20)
- c)  (5 + 5 + 5 = 15)

Homework

Write number sentences for the following:

1.  (2 + 2 + 2 + 2 = 8)
2.  (2 + 2 + 2 + 2 + 2 + 2 + 2 = 14)
3.  (2 + 2 + 2 + 2 + 2 + 2 + 2 + 2 = 16)

LESSON 23: 5s AND 2s – REPEATED ADDITION UP TO 20

Teacher’s notes

CAPS topics: 1.1 Count objects, 1.2 Count forwards and backwards, 1.16 Mental mathematics, 1.12 Techniques (methods or strategies), 1.14 Repeated addition leading to multiplication.

Lesson vocabulary: Forwards, backwards, groups of, add, equals, repeated addition, less than, more than, calculation, number sentence.

Prior knowledge: Learners should have been taught how to:

- Recognise, identify and read number symbols **0** to **80**.
- Use the following techniques when performing calculations: concrete apparatus, drawings, building up and breaking down numbers, doubling and halving, number lines.
- Do repeated addition in the range 0–15.

Concepts:

- Repeated addition in the range 0–20.
- Use the following techniques when performing calculations: concrete apparatus and drawings.

Resources: Whiteboards/scrap paper, counters.

DBE workbook activities relevant to this lesson:

- DBE Worksheet 118 (pp. 108 and 109).

Assessment: Refer to the tracker for today’s formal/informal oral, practical or written assessment activity.

Remediation: Draw the following on the board: ○○○○○ ○○○○○

Help the learners to write the number sentence ($5 + 5 = 10$).

Draw the following on the board: ○○ ○○ ○○

Help the learners to write the number sentence ($2 + 2 + 2 = 6$).

Do the same with 4 groups of 5, and 6 groups of 2.

Enrichment: See enrichment activity cards.

1. Mental mathematics

1.1 Counting (5 minutes)

- Count forwards and backwards in fives from any multiple between 0 and 100.
E.g. forwards 60, 65, 70...
backwards 70, 65, 60...

1.2 Mental mathematics activity (10 minutes)

	What is 2 less than:	Answer
1.	18?	16
2.	13?	11
3.	20?	18
4.	15?	13
5.	17?	15

	What is 2 more than:	Answer
6.	10?	12
7.	15?	17
8.	12?	14
9.	17?	19
10.	11?	13



2. Correction/reflection on homework (15 minutes)

Reflection/remediation based on previous day’s work/homework.



3. Lesson content – concept development (30 minutes)

This lesson gives more time for learners to work with repeated addition. In this lesson the groups being added relate to real contexts. The number sentences should again be recorded as this is the mathematical record of the operation.

Activity 1: Whole class activity

- Work on whiteboards/scrap paper.
- Draw a flower with 5 petals on the board. ()
- Point out to the learners that this flower has 5 petals.
- Draw another flower next to the first one. ()
- *How many petals will two flowers have?* (10)
- Ask the learners to write the number sentence ($5 + 5 = 10$).
- Do the same with 3 flowers and 4 flowers.
- Ask: *Can you think of anything else that comes in 5s? Discuss their ideas and make up a few repeated addition number sentences to go with them.* (E.g. I pack biscuits in small packets with 5 biscuits in each packet. If I pack 2 packets, how many biscuits do I have?)

Activity 2: Whole class activity

- Work on whiteboards/scrap paper.
- Draw a bird with 2 legs on the board. ()
- Point out to the learners that this bird has 2 legs.
- Draw another bird next to the first one. ()
- *How many legs will two birds have?* (4)
- Ask the learners to write the number sentence ($2 + 2 = 4$).
- Do the same with 3 birds and 4 birds.
- Ask: *Can you think of anything else that comes in 2s? Discuss their ideas and make up a few repeated addition number sentences to go with them.* (E.g. There are 2 shoes in a pair of shoes. If I have 2 pairs of shoes, how many shoes do I have?)

4. Classwork activity from LAB (25 minutes) (See next page)

5. Homework activity from LAB (5 minutes) (See next page)

6. Reflection on lesson

Term 4 Lesson 23: 5s and 2s – repeated addition to 20

Classwork

1. Draw the picture and write the number sentence.

a) I have three flowers. Each flower has 5 petals. How many petals are there in total?

( $5 + 5 + 5 = 15$)

b) I see eight birds. Each bird has 2 wings. How many wings are there in total?

( $2 + 2 + 2 + 2 + 2 + 2 + 2 + 2 = 16$)

2. Write a number sentence for the following:

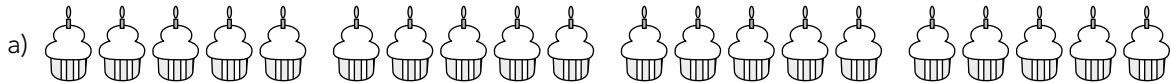

($5 + 5 + 5 + 5 = 20$)

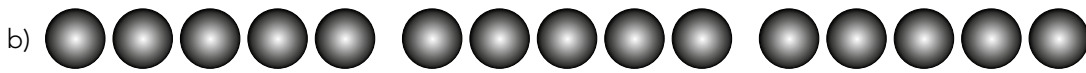

($5 + 5 + 5 = 15$)

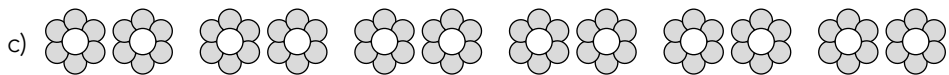

($2 + 2 + 2 + 2 + 2 + 2 = 12$)



($2 + 2 + 2 + 2 + 2 + 2 + 2 + 2 + 2 + 2 = 20$)

Homework

1. Draw the picture and write the number sentence.

a) Mom has four flowers. Each flower has 5 petals. How many petals are there in total?

( $5 + 5 + 5 + 5 = 20$)

b) I see five birds. Each bird has 2 wings. How many wings are there in total?

( $2 + 2 + 2 + 2 + 2 = 10$)

2. Write a number sentence for the following:



($2 + 2 + 2 + 2 + 2 = 10$)



($5 + 5 + 5 = 15$)

LESSON 24: GROUPS OF 5 AND GROUPS OF 2 UP TO 20

Teacher's notes

CAPS topics: 1.1 Count objects, 1.2 Count forwards and backwards, 1.16 Mental mathematics, 1.12 Techniques (methods or strategies), 1.14 Repeated addition leading to multiplication, 1.9 Grouping and sharing leading to division.

Lesson vocabulary: Groups of, equals, forwards, backwards, between, grouping.

Prior knowledge: Learners should have been taught how to:

- Recognise, identify and read number symbols **0** to **80**.
- Use the following techniques when performing calculations: concrete apparatus, drawings, building up and breaking down numbers, doubling and halving, number lines.
- Do repeated addition in the range 0–15.
- Group and share in the range 0–15.

Concepts:

- Grouping and sharing in the range 0–20.
- Use the following techniques when performing calculations: concrete apparatus and drawings.

Resources: Counters, pictures (e.g. hands, stars, pairs of socks, shoes – find your own).

DBE workbook activities relevant to this lesson:

- DBE Worksheet 112 (pp. 96 and 97).

Assessment: Refer to the tracker for today's formal/informal oral, practical or written assessment activity.

Remediation: Give the learners 20 counters. Help them to make groups of 5. (○○○○○ ○○○○○ ○○○○○ ○○○○○). Learners count the number of groups. (4)
 Help the learners to make groups of 2. (○○ ○○ ○○ ○○ ○○ ○○ ○○ ○○ ○○ ○○ ○○). Learners count the number of groups. (10)

Enrichment: See enrichment activity cards.

1. Mental mathematics

1.1 Counting (5 minutes)

- Count forwards and backwards in twos from any multiple between 0 and 100.
 E.g. forwards 48, 50, 52...
 backwards 84, 82, 80...

1.2 Mental mathematics activity (10 minutes)

	Give any number between the two given numbers:	Answer
1.	11 and 16	12/13/14/15
2.	9 and 13	10/11/12
3.	12 and 17	13/14/15/16
4.	15 and 19	16/17/18
5.	10 and 15	11/12/13/14

	Give any number between the two given numbers:	Answer
6.	8 and 14	9/10/11/12/13
7.	11 and 13	12
8.	16 and 20	17/18/19
9.	13 and 16	14/15
10.	17 and 20	18/19

2. Correction/reflection on homework (15 minutes)

Reflection/remediation based on previous day's work/homework.

3. Lesson content – concept development (30 minutes)

In this lesson (and the next one) you consolidate the learning about grouping division. When you do grouping division you know how big to make the group and you find out how many such groups you can make, using a given number of objects. Refer to the lesson vocabulary list (and Jika IMfundo dictionary) to recap the terminology relevant to the lesson.

Activity 1: Whole class activity

This short activity revises counting in 5s, as preparation for grouping into 5s.

- Show the learners a picture of 5 fingers.
- Ask *How many fingers do you see?* (5)
- *How many fingers are there on 1 hand?* (5)
- *So if there are 5 fingers in this picture, then how many hands will there be?* (1)
- Repeat with 10 fingers, 15 fingers and 20 fingers.

Activity 2: Learners work in groups

- Give each group of learners 20 counters.
- Ask learners to put the counters in groups of 5, i.e. 5 counters in a group.
(○○○○○ ○○○○○ ○○○○○ ○○○○○)
- Ask the learners: *How many groups did you make?* (4)
- Ask the learners to put out 10 counters.
- Ask them to put the counters in groups of 5.
(○○○○○ ○○○○○)
- Ask the learners: *How many groups did you make?* (2)
- Do the same with 15 counters and other numbers of counters if there is time.

Activity 3: Learners work in groups

- Learners continue working with the counters.
- Ask learners to put the counters in groups of 2, i.e. 2 counters in a group.
(○○ ○○ ○○ ○○ ○○ ○○ ○○ ○○ ○○ ○○ ○○)
- Ask the learners: *How many groups did you make?* (10)
- Ask the learners to put out 10 counters.
- Ask them to put the counters in groups of 2.
(○○ ○○ ○○ ○○ ○○)
- Ask the learners: *How many groups did you make?* (5)
- Do the same with 14 counters and other numbers of counters if there is time.

4. Classwork activity from LAB (25 minutes) (See next page)

5. Homework activity from LAB (5 minutes) (See next page)

6. Reflection on lesson

Term 4 Lesson 24: Groups of 5 and groups of 2 up to 20

Classwork

1. Draw circles to make groups of 5. How many groups did you make?

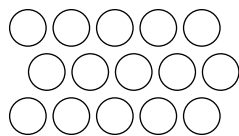
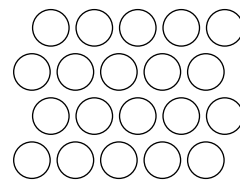
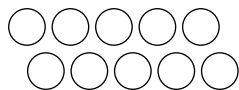
 <div style="border: 1px solid black; display: inline-block; padding: 2px 5px; margin: 5px 0;">(1)</div> (1 group of 5)	 <div style="border: 1px solid black; display: inline-block; padding: 2px 5px; margin: 5px 0;">(3)</div> (3 groups of 5)	 <div style="border: 1px solid black; display: inline-block; padding: 2px 5px; margin: 5px 0;">(4)</div> (4 groups of 5)	 <div style="border: 1px solid black; display: inline-block; padding: 2px 5px; margin: 5px 0;">(2)</div> (2 groups of 5)
---	--	---	--

2. Draw circles to make groups of 2. How many groups did you make?

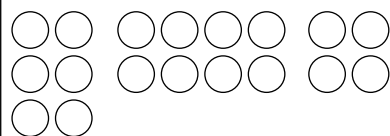
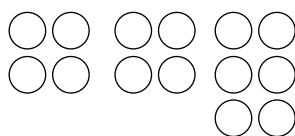
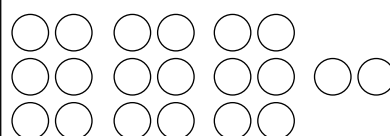
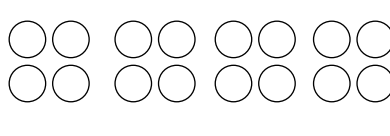
 <div style="border: 1px solid black; display: inline-block; padding: 2px 5px; margin: 5px 0;">(9)</div> (9 groups of 2)	 <div style="border: 1px solid black; display: inline-block; padding: 2px 5px; margin: 5px 0;">(7)</div> (7 groups of 2)
 <div style="border: 1px solid black; display: inline-block; padding: 2px 5px; margin: 5px 0;">(10)</div> (10 groups of 2)	 <div style="border: 1px solid black; display: inline-block; padding: 2px 5px; margin: 5px 0;">(8)</div> (8 groups of 2)

3. Draw 3 groups of 2. (○○ ○○ ○○)

4. Draw 3 groups of 5. (○○○○○ ○○○○ ○○○○)

Homework

1. Draw circles to make groups of 5. How many groups did you make?
 ○○○○○○ ○○○○○○ ○○○○○○ __ groups.
 (3 groups)

2. Draw circles to make groups of 2. How many groups did you make?
 ☆☆☆☆☆ ☆☆☆☆☆ ☆☆☆☆☆ ☆☆☆☆☆ ☆☆☆☆☆ __ groups.
 (8 groups)

3. Draw 2 groups of 5.

4. Draw 7 groups of 2.

LESSON 25: GROUPS OF 5 AND GROUPS OF 2 UP TO 20

Teacher's notes

CAPS topics: 1.1 Count objects, 1.2 Count forwards and backwards, 1.16 Mental mathematics, 1.12 Techniques (methods or strategies), 1.14 Repeated addition leading to multiplication, 1.9 Grouping and sharing leading to division.

Lesson vocabulary: Groups of, equals, forwards, backwards, add, grouping, calculation.

Prior knowledge: Learners should have been taught how to:

- Recognise, identify and read number symbols **0** to **80**.
- Use the following techniques when performing calculations: concrete apparatus, drawings, building up and breaking down numbers, doubling and halving, number lines.
- Do repeated addition in the range 0–15.
- Group and share in the range 0–15.

Concepts:

- Grouping and sharing in the range 0–20.
- Use the following techniques when performing calculations: concrete apparatus and drawings.

Resources: Counters.

DBE workbook activities relevant to this lesson:

- DBE Worksheet 117 (pp. 106 and 107).

Assessment: Refer to the tracker for today's formal/informal oral, practical or written assessment activity.

Remediation: Give the learners 20 counters. Help them to make groups of 5.

(○○○○○ ○○○○○ ○○○○○ ○○○○○)

Help the learners to count how many groups they have. Do the same with 15 and 10 counters in groups of 5.

Do the same with 16, 12 and 18 counters in groups of 2.

Enrichment: See enrichment activity cards.

1. Mental mathematics

1.1 Counting (5 minutes)

- Count forwards and backwards in tens from any multiple between 0 and 100.
E.g. forwards 20, 30, 40...
backwards 70, 60, 50...

1.2 Mental mathematics activity (10 minutes)

	Add the following:	Answer
1.	$1 + 4 + 2 = \underline{\quad}$	7
2.	$2 + 1 + 5 = \underline{\quad}$	8
3.	$2 + 3 + 4 = \underline{\quad}$	9
4.	$3 + 4 + 1 = \underline{\quad}$	8
5.	$5 + 2 + 2 = \underline{\quad}$	9

	Add the following:	Answer
6.	$4 + 2 + 4 = \underline{\quad}$	10
7.	$5 + 1 + 2 = \underline{\quad}$	8
8.	$3 + 3 + 1 = \underline{\quad}$	7
9.	$7 + 1 + 2 = \underline{\quad}$	10
10.	$8 + 1 + 0 = \underline{\quad}$	9

2. Correction/reflection on homework (15 minutes)

Reflection/remediation based on previous day's work/homework.

3. Lesson content – concept development (30 minutes)

This lesson gives more time for learners to work with grouping division. In the first activity learners work with counters to do grouping division. In the second activity word problems involving grouping division are discussed. It is important to include word problems in order for learners to use maths as a life skill and to learn how to use reasoning to find solutions to given problems.

In this lesson you could start to use the mathematical word 'divide' although you do not yet record division number sentences (unless you would like to introduce the division sign). The division sign is officially introduced in Grade 2 although you may decide to introduce it earlier in order to record a division number sentence more easily.

Activity 1: Learners work in groups

- Give each group of learners 20 counters.
- Revise grouping the counters like you did in the previous lesson.
- Ask the learners to make groups of 5. (○○○○○ ○○○○○ ○○○○○ ○○○○○)
- Ask the learners: *How many groups of 5 did you make?* (4)
- So we can say that if I divide 20 into groups of 5, I make 4 groups of 5.
- Ask the learners to make groups of 2. (○○ ○○ ○○ ○○ ○○ ○○ ○○ ○○ ○○ ○○ ○○)
- Ask the learners: *How many groups of 2 are there?* (10)
- So we can say that if I divide 20 into groups of 2, I make 10 groups of 2.
- Group other numbers of counters into 2s and 5s if you think the class need more practice before moving on to the word problems.

Activity 2: Learners work in groups of four

- Learners continue working with the 20 counters to help them solve word problems.
- *A farmer has 15 eggs. He puts 5 eggs in each box. How many boxes does he need?* (3)
Guide the children to put 15 counters into groups of 5. (○○○○○ ○○○○○ ○○○○○)
- *A man has 10 books. He puts 5 books on each shelf. How many shelves does he need?* (2)
Guide the children to put 10 counters into groups of 5. (○○○○○ ○○○○○)
- *A man has 10 dogs. He puts 2 dogs in each kennel. How many kennels does he need?* (5)
Guide the children to put 10 counters into groups of 2. (○○ ○○ ○○ ○○ ○○)
- *Mom has 14 cupcakes. She puts 2 cupcakes in each box. How many boxes does she need?* (7). Guide the children to put 14 counters into groups of 2. (○○ ○○ ○○ ○○ ○○ ○○ ○○)
- Ask learners to make up other word problems like the ones you have just done to practice grouping division. Help them to make up problems that are appropriate. The mental activity of making up word problems is a powerful learning experience.

4. Classwork activity from LAB (25 minutes) (See next page)



5. Homework activity from LAB (5 minutes) (See next page)

6. Reflection on lesson

Term 4 Lesson 25: Groups of 5 and groups of 2 up to 20

Classwork

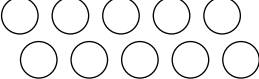
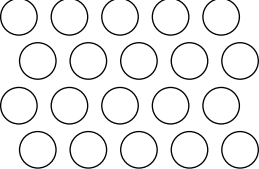
1. Draw circles to make groups of 5.

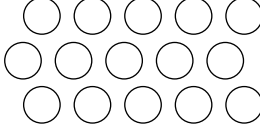
 <p>(2 groups of 5)</p>	 <p>(4 groups of 5)</p>	 <p>(1 group of 5)</p>	 <p>(3 groups of 5)</p>
--	--	--	--

2. Draw circles to make groups of 2.

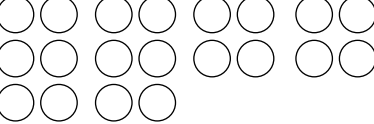
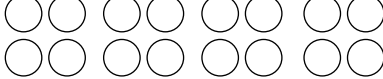
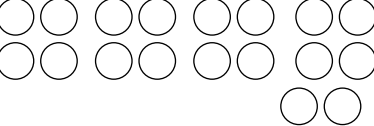
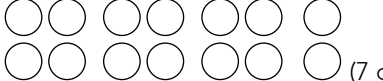
 <p>(10 groups of 2)</p>	 <p>(8 groups of 2)</p>
 <p>(9 groups of 2)</p>	 <p>(7 groups of 2)</p>

3. Solve the problems:

- Phindi puts 20 flowers into bunches. She puts 5 flowers in each bunch. How many bunches does she make? (4 bunches – 4 groups of 5.)
- Maymoona puts 12 books into piles. She puts 2 books in each pile. How many piles does she make? (6 piles – 6 groups of 2.)
- Kevin puts 18 marbles into groups of 2. How many groups does he make? (9 groups of 2.)
- Kabelo puts 15 sticks into piles of 5. How many piles does he make? (3 piles – 3 groups of 5.)

Homework

1. Solve the problems:

- Ayanda puts 16 sweets into packets. Each packet has 2 sweets. How many packets does she make? (8 packets – 8 groups of 2.)
- Bheki uses 10 building blocks to build towers. Each tower has 5 blocks. How many towers does he build? (2 towers – 2 groups of 5.)

WEEK 6

LESSON 26: SHARING 5s UP TO 20

Teacher's notes

CAPS topics: 1.1 Count objects, 1.2 Count forwards and backwards, 1.16 Mental mathematics, 1.12 Techniques (methods or strategies), 1.9 Grouping and sharing leading to division.

Lesson vocabulary: Forwards, backwards, share, between, group, equals, whole numbers, double, half, sharing, grouping, calculation.

Prior knowledge: Learners should have been taught how to:

- Recognise, identify and read number symbols **0** to **80**.
- Use the following techniques when performing calculations: concrete apparatus, drawings, building up and breaking down numbers, doubling and halving, number lines.
- Solve and explain solutions to practical problems involving equal sharing and grouping with whole numbers up to 15 and with answers that may include remainders.

Concepts:

- Solve and explain solutions to practical problems involving equal sharing and grouping with whole numbers up to 20 and with answers that may include remainders.
- Use the following techniques when performing calculations: concrete apparatus and drawings.

Resources: Whiteboards/scrap paper, counters.

DBE workbook activities relevant to this lesson:

- N/A

Assessment: Refer to the tracker for today's formal/informal oral, practical or written assessment activity.

Remediation: Learners work in groups of 5. Give each group 10 counters. Help them to share the counters between themselves (sharing between five children). Ask: *How many counters did you each get?* (2) Repeat with 20 counters and 5 children (4 counters each).

Enrichment: See enrichment activity cards.

1. Mental mathematics

1.1 Counting (5 minutes)

- Count forwards and backwards in ones from 0 and 100, starting from any number.
E.g. forwards 29, 30, 31...
backwards 77, 76, 75...

1.2 Mental mathematics activity (10 minutes)

	What is double...	Answer
1.	2?	4
2.	1?	2
3.	4?	8
4.	6?	12
5.	8?	16

	What is half of...	Answer
6.	18?	9
7.	2?	1
8.	14?	7
9.	6?	3
10.	20?	10

2. Correction/reflection on homework (15 minutes)

Reflection/remediation based on previous day's work/homework.

3. Lesson content – concept development (30 minutes)

This is the first of three lessons in which you consolidate the learning about sharing division. When you do sharing division you know how many learners (for example) you want to share things between, and you want to find out how many sweets (for example) each learner will get.

Activity 1: Whole class activity

- Give the learners counters and whiteboards/scrap paper.
- *We are going to take 15 counters and share them between 5 children.*
- Ask the learners to draw 5 children (stick figures) on their whiteboards/scrap paper.
- They must then take the 15 counters and share them between the 5 children by giving them each one counter at a time.

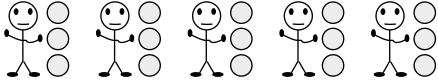

- *How many counters do they each get?* (3)
- Repeat with 20 counters and 5 children. (4)

Activity 2: Whole class activity

- Give the learners whiteboards/scrap paper so that they can draw their solutions to the word problems.
- Remind learners that sometimes when you share you may get a remainder. Explain again what a remainder is, using an example.
- If I share 3 sweets between 2 children fairly, how many sweets does each child get? (1 sweet each and one is left over. There is a remainder of 1 when I divide 3 by 2.)
- Give the learners slates/whiteboards so that they can draw their solutions to the word problems.
- Give the learners these word problems to solve:
 - *5 children share 10 sweets. How many sweets does each child get?* (2)
Learners draw: ○○ ○○ ○○ ○○ ○○
 - *5 children share 11 sweets. How many sweets does each child get?* (2 and 1 left over)
Learners draw: ○○ ○○ ○○ ○○ ○○ (2 each) ○ (1 left over)
 - *5 dogs share 15 bones. How many bones does each dog get?* (3)
Learners draw: ○○○ ○○○ ○○○ ○○○ ○○○
 - *5 dogs share 8 bones. How many bones does each dog get?* (1 and 3 left over)
Learners draw: ○ ○ ○ ○ ○ (1 each) ○ ○ ○ (3 left over)
 - *5 children share 20 books. How many books does each child get?* (4)
Learners draw: ○○○○ ○○○○ ○○○○ ○○○○ ○○○○

4. Classwork activity from LAB (25 minutes) (See next page)

5. Homework activity from LAB (5 minutes) (See next page)

6. Reflection on lesson

Term 4 Lesson 26: Sharing 5s up to 20

Classwork

1. Share the sweets in the 3 pictures below between five friends. How many sweets will each friend get?

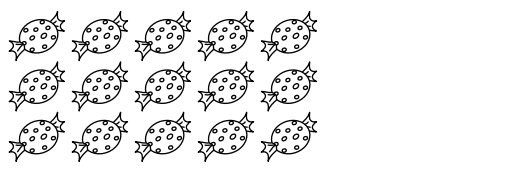
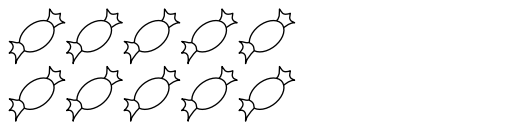
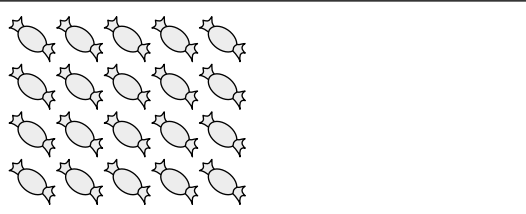
a)		<input style="width: 40px; height: 30px;" type="text"/>	(3 sweets)
b)		<input style="width: 40px; height: 30px;" type="text"/>	(2 sweets)
c)		<input style="width: 40px; height: 30px;" type="text"/>	(4 sweets)

2. Make a drawing to show the following. How many counters do they each get? Are there any counters left?

a) Share 10 counters between five children.

	They each get __ (2) counters. There are __ (0) left.
---	--

b) Share 6 counters between five children.

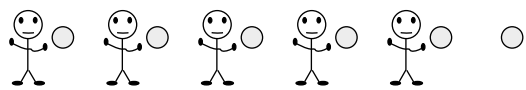
	They each get __ (1) counter. There is __ (1) left.
---	--

c) Share 11 counters between five children.

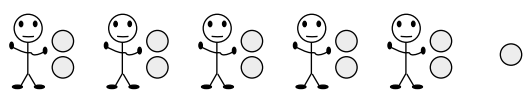
	They each get __ (2) counters. There is __ (1) left.
---	---

d) Share 20 counters between five children.

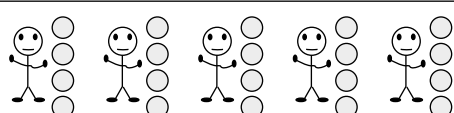
	They each get __ (4) counters. There are __ (0) left.
---	--

Homework

1. Solve the word problem. You can draw a picture to help you.

Share fifteen sweets between five children. How many sweets do they each get?

	They each get __ (3) sweets.
---	------------------------------

LESSON 27: SHARING 2s UP TO 20

Teacher's notes

CAPS topics: 1.1 Count objects, 1.2 Count forwards and backwards, 1.16 Mental mathematics, 1.12 Techniques (methods or strategies), 1.9 Grouping and sharing leading to division.

Lesson vocabulary: Forwards, backwards, share, equals, grouping, sharing, half.

Prior knowledge: Learners should have been taught how to:

- Recognise, identify and read number symbols **0** to **80**.
- Use the following techniques when performing calculations: concrete apparatus, drawings, building up and breaking down numbers, doubling and halving, number lines.
- Solve and explain solutions to practical problems involving equal sharing and grouping with whole numbers up to 15 and with answers that may include remainders.

Concepts:

- Solve and explain solutions to practical problems involving equal sharing and grouping with whole numbers up to 20 and with answers that may include remainders.
- Use the following to solve problems: concrete apparatus, drawings.

Resources: Whiteboards/scrap paper, counters.

DBE workbook activities relevant to this lesson:

- N/A

Assessment: Refer to the tracker for today's formal/informal oral, practical or written assessment activity.

Remediation: Give learners 10 counters. Help them to share the counters between 2 learners. Ask: *How many counters did you each get?* (5) Repeat with 16 counters and 2 learners. (8 counters).

Enrichment: See enrichment activity cards.

1. Mental mathematics

1.1 Counting (5 minutes)

- Count forwards and backwards in fives from any multiple between 0 and 100, starting from any number.
E.g. forwards 60, 65, 70 ...
backwards 100, 95, 90...

1.2 Mental mathematics activity (10 minutes)

	What is half of ...	Answer
1.	4?	2
2.	18?	9
3.	2?	1
4.	16?	8
5.	20?	10

	What is half of ...	Answer
6.	6?	3
7.	14?	7
8.	10?	5
9.	12?	6
10.	8?	4

2. Correction/reflection on homework (15 minutes)

Reflection/remediation based on previous day's work/homework.

3. Lesson content – concept development (30 minutes)

This lesson gives more time for learners to work with sharing division. In the first activity learners work with counters and do drawings and in the second activity word problems involving sharing division are discussed.

Activity 1: Whole class activity

- Give each group of learners 20 counters and whiteboards/scrap paper.
- *We are going to take 14 counters and share them between 2 children.*
- Ask the learners to draw 2 children (stick figures) on their whiteboards/scrap paper.
- They must then take the 14 counters and share them between the 2 children.

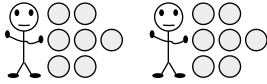

- *How many counters do they each get? (7)*
- Repeat with 10 counters and 2 children. (5)

Activity 2: Whole class activity

- Give the learners whiteboards/scrap paper so that they can draw their solutions to the word problems.
- Give the learners the following word problems to solve:

- *2 children share 12 toys. How many toys does each child get? (6)*

Learners draw: ○○○○○○ ○○○○○○

- *2 puppies share 6 biscuits. How many biscuits does each puppy get? (3)*

Learners draw: ○○○ ○○○

- *2 caterpillars share 18 leaves. How many leaves does each caterpillar get? (9)*

Learners draw: ○○○ ○○○
○○○ ○○○
○○○ ○○○

4. Classwork activity from LAB (25 minutes) (See next page)

5. Homework activity from LAB (5 minutes) (See next page)

6. Reflection on lesson

Term 4 Lesson 27: Sharing 2s up to 20

Classwork

1. Share the sweets in the 3 pictures between two friends. How many sweets will each friend get?

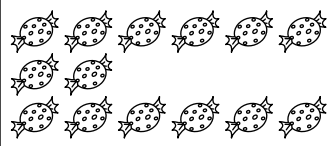
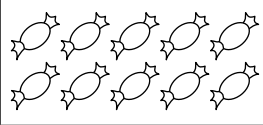
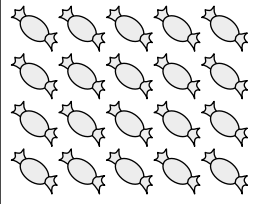
a)		<input style="width: 40px; height: 30px;" type="text"/>	(7 sweets)
b)		<input style="width: 40px; height: 30px;" type="text"/>	(5 sweets)
c)		<input style="width: 40px; height: 30px;" type="text"/>	(10 sweets)

2. Make a drawing to show the following. How many counters do they each get? How many counters are left?

a) Share 10 counters between two children.

	They each get __ (5) counters. There are __ (0) left.
--	--

b) Share 7 counters between two children.

	They each get __ (3) counters. There is __ (1) left.
---	---

c) Share 11 counters between two children.

	They each get __ (5) counters. There is __ (1) left.
---	---

d) Share 20 counters between two children.

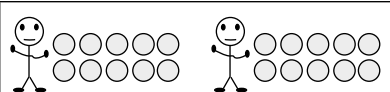
	They each get __ (10) counters. There are __ (0) left.
---	---

Homework

1. Solve the word problem. You can draw a picture to help you.

Share 18 sweets between two children. How many sweets do they each get?

) They each get __ (9) sweets.
---	--------------------------------

LESSON 28: SHARING WITH REMAINDERS

Teacher's notes

CAPS topics: 1.1 Count objects, 1.2 Count forwards and backwards, 1.16 Mental mathematics, 1.12 Techniques (methods or strategies), 1.9 Grouping and sharing leading to division.

Lesson vocabulary: Forwards, backwards, equal sharing, grouping, left over, share, explain.

Prior knowledge: Learners should have been taught how to:

- Recognise, identify and read number symbols **0** to **80**.
- Use the following techniques when performing calculations: concrete apparatus, drawings, building up and breaking down numbers, doubling and halving, number lines.
- Solve and explain solutions to practical problems involving equal sharing and grouping with whole numbers up to 15 and with answers that may include remainders.

Concepts:

- Solve and explain solutions to practical problems involving equal sharing and grouping with whole numbers up to 20 and with answers that may include remainders.
- Use the following: concrete apparatus, drawings.

Resources: Whiteboards/scrap paper, counters.

DBE workbook activities relevant to this lesson:

- DBE Worksheet 114 (pp. 100 and 101).

Assessment: Refer to the tracker for today's formal/informal oral, practical or written assessment activity.

Remediation: Give the learners 20 counters. Help them to solve the following (using the counters if they need to but try to do the calculations without counters if possible): *Share 10 sweets among three children so that they all get the same number of sweets. How many sweets did they each get? (3 and 1 left over.) Phumi shares 8 suckers with her friend. How many suckers will they each get? (4)* Do other similar problems with and without remainders.

Enrichment: See enrichment activity cards.

1. Mental mathematics

1.1 Counting (5 minutes)

- Count forwards and backwards in fives from any multiple between 0 and 100, starting from any number.
E.g. forwards 35, 40, 45...
backwards 85, 80, 75...

1.2 Mental mathematics activity (10 minutes)

	Complete the following:	Answer
1.	$__ + 2 = 9$	7
2.	$__ + 5 = 7$	2
3.	$__ + 1 = 8$	7
4.	$__ + 3 = 10$	7
5.	$__ + 4 = 6$	2

	Complete the following:	Answer
6.	$__ + 1 = 5$	4
7.	$__ + 6 = 9$	3
8.	$__ + 3 = 8$	5
9.	$__ + 4 = 7$	3
10.	$__ + 5 = 10$	5

2. Correction/reflection on homework (15 minutes)

Reflection/remediation based on previous day's work/homework.

3. Lesson content – concept development (30 minutes)

Activity 1: Whole class activity

- Give each group of learners counters and whiteboards/scrap paper.
- Work together to solve the following problem:
- *Share 16 sweets among three friends so that they all get the same number of sweets.*
- Ask the learners to draw 3 children (stick figures) on their whiteboards/scrap paper.
- They must then take the 16 sweets and share them between the 3 children.



- *How many sweets do they each get?* (5)
- *Are there any left over?* (Yes, 1.)
- Repeat with 11 sweets and 2 friends. (5 and 1 left over.)

Activity 2: Whole class activity

- Work together to solve the following problem:
- *Share 9 chocolate bars among 4 friends so that they all get the same amount of chocolate.*
- Ask the learners to draw 4 children (stick figures) on their whiteboards/scrap paper.
- They must then draw the 9 chocolate bars and share them between the 4 children.

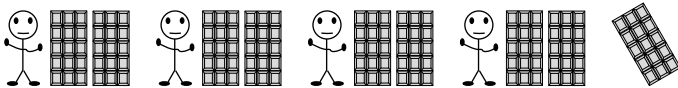

- First, each child gets 2 slabs of chocolate. There is one slab left over.
- *What do you think we can do with the bar that is left over?* (Cut it up and give each child an equal piece.)
- Each child will get 2 and a quarter slabs of chocolate. Remind learners what a quarter is – in this case one of four parts of the slab of chocolate that are equal in size.
- Repeat with 17 chocolates and 8 children. (2 and 1 left over.)

4. Classwork activity from LAB (25 minutes) (See next page)

5. Homework activity from LAB (5 minutes) (See next page)

6. Reflection on lesson

Term 4 Lesson 28: Sharing with remainders

Classwork

Solve the following. Draw a picture to help you.

1. Mom has 20 oranges. She shares them among her four children so that they all get the same number of oranges. How many oranges do they each get?

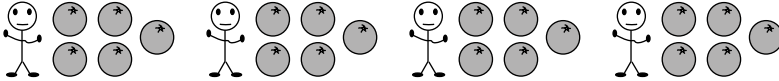
	(5 oranges)
---	-------------

2. Khwezi wants to give 16 eggs to her 3 neighbours. How many eggs will each neighbour get?

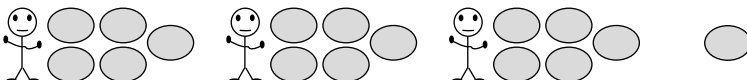
	(5 eggs and one left over)
---	----------------------------

3. Mom wants to share 7 chocolate bars between 3 children so that they all get the same amount of chocolate. How many chocolate bars will they each get?

	(2 and one left over)
---	-----------------------

4. Gogo sells 12 bananas to 6 people. How many bananas does each person get?

	(2)
--	-----

Homework

Solve the following. Draw a picture to help you.

1. You have 17 apples. You share them between 4 friends. How many apples will each friend get?



They will each get ___ apples. (4)

There will be ___ left over. (1)

LESSON 29: DATA

Teacher's notes

CAPS topics: 1.2 Count forwards and backwards, 1.16 Mental mathematics, 5.6 Analyse and interpret data.

Lesson vocabulary: Forwards, backwards, data, analyse, interpret, pictograph, circle, triangle, square, star, less than, more than.

Prior knowledge: Learners should have been taught how to:

- Collect and organise data about the class or school and answer questions posed by the teacher.
- Represent data in pictograph; Answer questions about data in pictograph.

Concepts:

- Analyse and interpret data – answer questions about data in pictographs.

Resources: Pictographs drawn on the board.

DBE workbook activities relevant to this lesson:

- DBE Worksheet 124 (pp. 120 and 121).

Assessment: Refer to the tracker for today's formal/informal oral, practical or written assessment activity.

Remediation: Draw the following pictograph on the board.

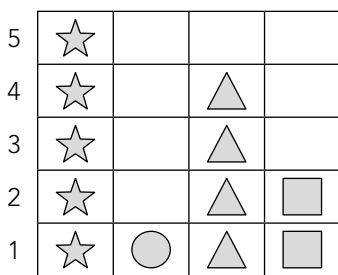

Discuss with the learners and assist them in answering the questions.

- How many squares are there? __ (2)
- How many triangles are there? __ (4)
- What can you tell me about the stars?
(There are 5 stars, the stars have the most.)
- What can you tell me about the circles?
(There is only 1 circle, the circles have the least.)

Enrichment: See enrichment activity cards.

1. Mental mathematics

1.1 Counting (5 minutes)

- Count forwards and backwards in ones from 0 and 100, starting from any number.

1.2 Mental mathematics activity (10 minutes)

	Complete the following:	Answer
1.	Complete: $__ + 3 = 6$	3
2.	Complete: $__ + 5 = 9$	4
3.	What is 2 less than 19?	17
4.	What is 2 more than 14?	16
5.	Which is less: 12 or 11?	11

	Complete the following:	Answer
6.	Complete: $__ + 1 = 5$	4
7.	Complete: $__ + 1 = 10$	9
8.	What is 2 less than 10?	8
9.	What is 2 more than 12?	14
10.	Which is more: 20 or 19?	20

2. Correction/reflection on homework (15 minutes)

Reflection/remediation based on previous day's work/homework.

3. Lesson content – concept development (30 minutes)

This term there are two final lessons for the year on Data Handling. You should use them to consolidate learning of the Data Handling concepts. Remember to refer to the Jika iMfundo dictionary if you need to for definitions and examples of the Data Handling vocabulary.

Activity 1: Whole class activity

- Preparation: Draw the following pictograph on the board. (Remember to also write the key on the board.)

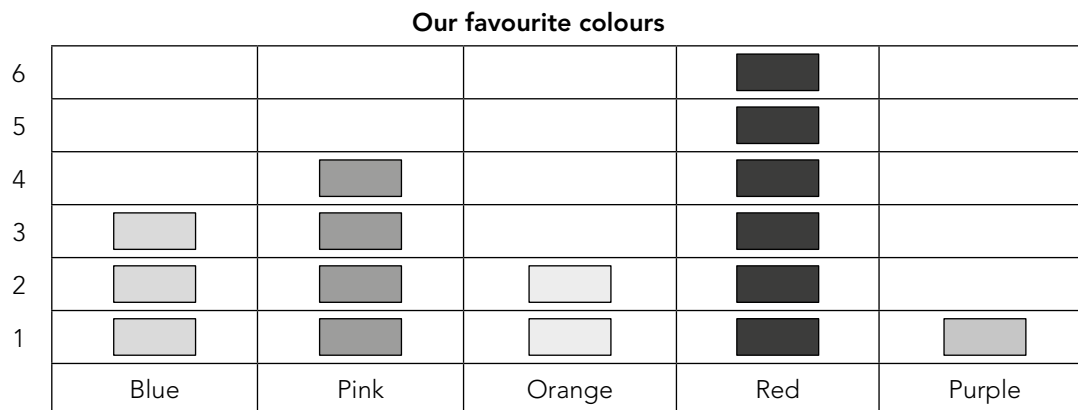

Key:  = one object

- Discuss the pictograph with the class. A pictograph summarises data that has been collected. This is a pictograph showing data about favourite colours.
- How do we know what the graph is about?* (We look at the title of the graph.)
- How do we know what each picture in the pictograph shows us?* (We look at the key of the graph.)
- What does the pictograph show?* (Favourite colours of some learners.)
- Which group has the most objects?* (Red group.)
- Which group has the least objects?* (Purple group.)
- Which group has more than the orange group but less than the pink group?* (Blue group.)

Activity 2: Whole class activity

- Discuss the following questions with the class with reference to the pictograph:
- How many children like the colour blue?* (3)
- How many children like the colour pink?* (4)
- What can you tell me about the colour orange?* (2 children like orange, more children like orange than purple, fewer children like orange than pink/blue/red.)
- What can you tell me about the colour red?* (6 children like red, red is the favourite colour.)
- What can you tell me about the colour purple?* (Only 1 child likes purple, purple is the least favourite colour.)

4. Classwork activity from LAB (25 minutes) (See next page)

5. Homework activity from LAB (5 minutes) (See next page)











6. Reflection on lesson

Term 4 Lesson 29: Data

Classwork

1. Look at the pictograph.

We like apples

5			
4			
3			
2			
1			
	Red apples	Yellow apples	Green apples













2. Answer the following:

- How many learners like green apples? (5)
- How many learners like red apples? (3)
- How many learners like yellow apples? (2)
- How many more learners like green apples than yellow apples? (3)
- How many more learners like red apples than yellow apples? (1)
- Which apple is the most popular? (Green apples)
- Which apple is the least popular? (Yellow apples)

Homework

Answer the questions about the pictograph:

- How many children like bananas? (5)
- How many fewer oranges are there than bananas? (4)
- How many more apples are there than strawberries? (1)
- Which is the favourite fruit? (Banana)
- Which is the least favourite fruit? (Orange)

Fruit				
5				
4				
3				
2				
1				
	Apple	Banana	Orange	Strawberry

LESSON 30: DATA

Teacher's notes

CAPS topics: 1.1 Count objects, 1.2 Count forwards and backwards, 1.16 Mental mathematics, 5.6 Analyse and interpret data.

Lesson vocabulary: Forwards, backwards, data, analyse, interpret, pictograph, more than, less than, triangle, circle, star, square.

Prior knowledge: Learners should have been taught how to:

- Recognise, identify and read number symbols **0** to **80**.
- Collect and organise data about the class or school and answer questions posed by the teacher.
- Represent data in pictograph.
- Answer questions about data in pictograph.

Concepts:

- Analyse and interpret data – answer questions about data in pictographs.

Resources: Pictographs drawn on the board.

DBE workbook activities relevant to this lesson:

- DBE Worksheet 125 (pp. 122 and 123).

Assessment: Refer to the tracker for today's formal/informal oral, practical or written assessment activity.

Remediation: Draw the following pictograph on the board. Discuss it with the learners and help them to answer the questions.

5		●		
4		●		↑
3	▲	●		↑
2	▲	●	■	↑
1	▲	●	■	↑
	Triangle	Circle	Square	Arrow

- How many arrows are there? __ (4)
- How many triangles are there? __ (3)
- What can you tell me about the circles?
(There are 5 circles, circles have the most.)
- What can you tell me about the squares?
(There are 2 squares, squares have the least.)

Enrichment: See enrichment activity cards.

1. Mental mathematics

1.1 Counting (5 minutes)

- Count forwards and backwards in ones from 0 and 100, starting from any number.

E.g. forwards 42, 43, 44...

backwards 81, 80, 79...

1.2 Mental mathematics activity (10 minutes)

	Which number is 3 more than...	Answer
1.	10?	13
2.	4?	7
3.	12?	15
4.	15?	18
5.	11?	14

	Which number is 3 less than...	Answer
6.	13?	10
7.	20?	17
8.	17?	14
9.	16?	13
10.	19?	16

2. Correction/reflection on homework (15 minutes)

Reflection/remediation based on previous day's work/homework.

3. Lesson content – concept development (30 minutes)

Activity 1: Whole class activity

- Preparation: Draw the following pictograph and its key on the board.
- Discuss the pictograph on the board.

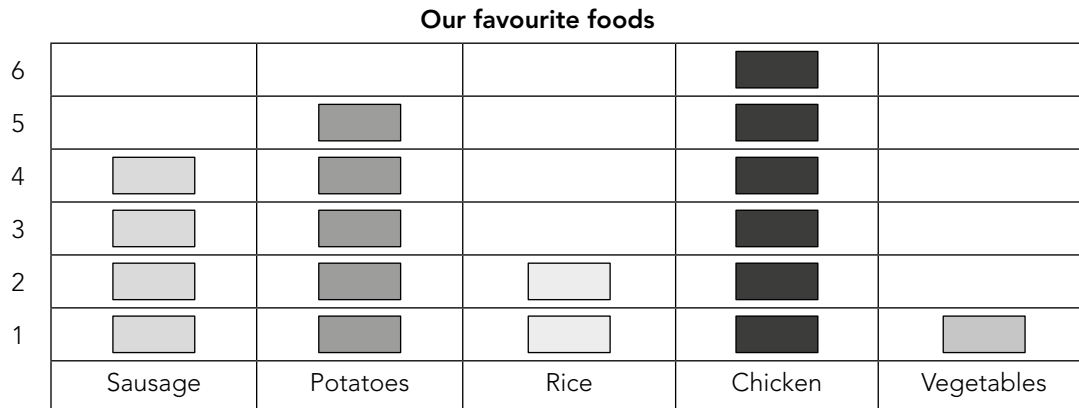

Key:  = one child

- What does the pictograph show? (Favourite foods of some learners.)
- How are the objects grouped? (According to favourite foods.)
- How many children like sausages? (4)
- How many children like rice? (2)
- Which food group has more than the sausages but less than the chicken? (Potatoes.)
- Etc.

Activity 2: Whole class activity

- Discuss the following questions with the class.
- The questions are not specific and there may be more than one answer that is correct. It will be good if learners offer different answers and you can allow free discussion of the different possibilities.
- Open discussion will stimulate learners to think widely about possible answers when they interpret graphs.
- If learners struggle with the more open questions you could get the discussion going by asking more direct questions such as:
- How many children like potatoes? (5) and so on.
- What can you tell me about potatoes? (5 children like potatoes; potatoes are the second favourite; more children like potatoes than sausages/rice/vegetables.)
- What can you tell me about vegetables? (Only 1 child likes vegetables; vegetables are the least favourite.)
- What can you tell me about chicken? (6 children like chicken, chicken is the favourite.)
- Etc.

4. Classwork activity from LAB (25 minutes) (See next page)

5. Homework activity from LAB (5 minutes) (See next page)



6. Reflection on lesson

Term 4 Lesson 30: Data

Classwork

- Data on favourite toys for pictograph:
Doll: 3; Truck: 2; Teddy bear: 4; Ball: 5
- Complete the pictograph.
(Learners must draw the icons in the pictograph using the given data values.)

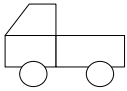
Favourite toys













5				
4				
3				
2				
1				
	 Doll	 Truck	 Teddy bear	 Ball

- Answer the following:
 - How many learners like dolls? (3)
 - How many learners like teddy bears? (4)
 - How many learners like balls? (5)
 - Which toy is the most popular? (Balls)
 - Which toy is the least popular? (Trucks)

Homework

Answer the questions about the pictograph:

- How many squares are there? (5)
- How many arrows are there? (1)
- How many triangles are there? (2)
- How many circles are there? (4)
- Which group has the most objects? (Square)
- Which group has the least objects? (Arrow)

Shapes we see				
5				
4				
3				
2				
1				
	Triangle	Circle	Square	Arrow

WEEK 7

LESSON 31: GEOMETRIC PATTERNS

Teacher's notes

CAPS topics: 1.2 Count forwards and backwards, 1.16 Mental mathematics, 2.1 Geometric patterns.

Lesson vocabulary: Forwards, backwards, geometric pattern, shapes, copy, create, extend, repeat, describe, line, shape, object, more than.

Prior knowledge: Learners should have been taught how to:

- Copy, extend and describe in words simple patterns made with physical objects and drawings of lines, shapes or objects.
- Create and describe own geometric patterns with physical objects and by drawing lines, shapes or objects.
- Describe own patterns.

Concepts:

- Identify, describe in words and copy geometric patterns in nature, from everyday life and from our cultural heritage.
- Create own geometric patterns with physical objects by drawing lines, shapes or objects.
- Describe own patterns.

Resources: Paper, crayons, collected objects, e.g. leaves.

DBE workbook activities relevant to this lesson:

- DBE Worksheet 127 (pp. 126 and 127).

Assessment: Refer to the tracker for today's formal/informal oral, practical or written assessment activity.

Remediation: Look around the classroom and identify patterns, e.g. the windows. Ask: *Do the windows have lines going across? Do the windows have lines going down? Is the pattern repeated in any way?* Talk about the pattern.

Enrichment: See enrichment activity cards.

1. Mental mathematics

1.1 Counting (5 minutes)

- Count forwards and backwards in twos from any multiple between 0 and 100, starting from any number.
E.g. forwards 22, 24, 26...
backwards 46, 44, 42...

1.2 Mental mathematics activity (10 minutes)

	What is 2 more than...	Answer
1.	13?	15
2.	11?	13
3.	14?	16
4.	4?	6
5.	8?	10

	What is 2 more than...	Answer
6.	18?	20
7.	9?	11
8.	17?	19
9.	15?	17
10.	10?	12

2. Correction/reflection on homework (15 minutes)

Reflection/remediation based on previous day's work/homework.

3. Lesson content – concept development (30 minutes)

The topic of geometric patterns provides an opportunity to recap naming of shapes (and talking about their characteristics, such as size). It also consolidates general thinking about patterns – sequences which develop and grow according to a rule. The rule for a geometric pattern is often found by counting and so geometric patterns link to number patterns as well.

Activity 1: Whole class activity

- Take the learners outside to each collect some leaves.
- Each learner needs to use one leaf, but they should collect a few leaves, in case some break or get damaged in some way.
- Ask the learners to look at the shapes of their leaves.
- Discuss the similarities and differences.
- Show the learners how to make a leaf rubbing: place leaf upside down on slate/whiteboard, place sheet of paper on top of leaf, rub the leaf with a pencil or crayon through the paper lightly – the shape of the leaf will emerge.
- Ask the learners to each make a few rubbings of the leaf they collected.
- They can then paste these leaf rubbings in a pattern on paper. E.g.



- Learners could make a pattern using more than one leaf if they want to, or using the leaf pointing in different directions.

Activity 2: Whole class activity

- Share your leaf patterns as a class.
- Allow some of the learners (those who want to and according to the amount of time left for this part of the lesson) to show their leaf rubbing patterns to the class and to describe how they made their patterns up using the shape in a regular way. (Give as many learners as possible the opportunity to present and explain the pattern they made.)

4. Classwork activity from LAB (25 minutes) (See next page)

5. Homework activity from LAB (5 minutes) (See next page)

6. Reflection on lesson

Term 4 Lesson 31: Geometric patterns

Classwork

1. Complete these patterns on the huts.
2. Colour them in when you have finished.

a)

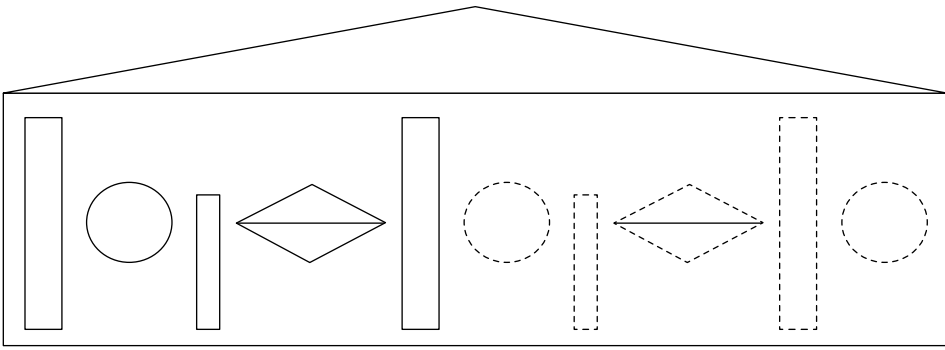

b)

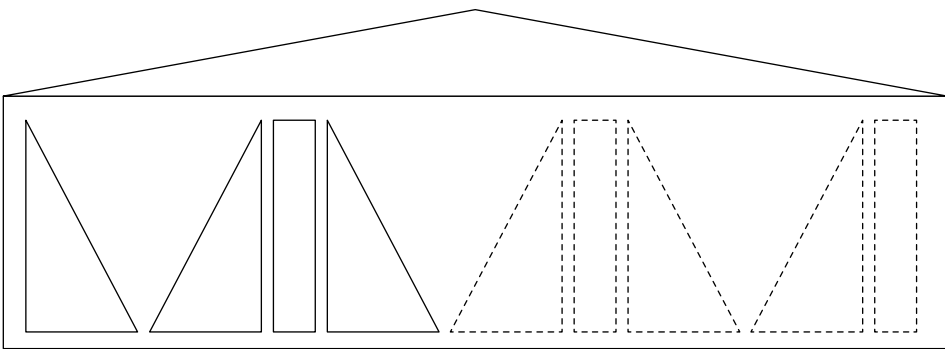

c)

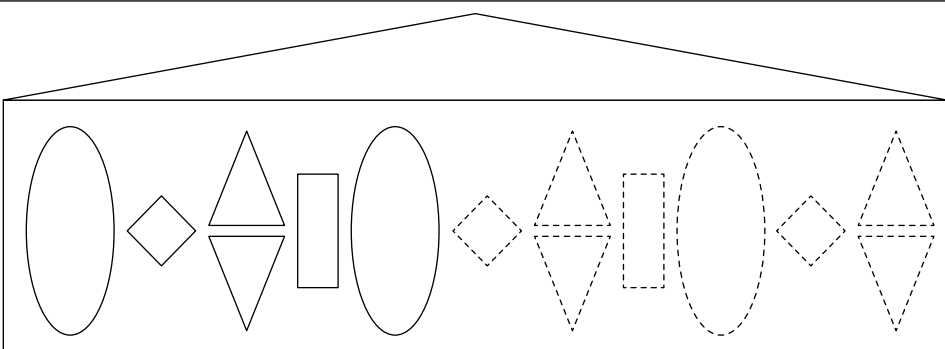

Homework

1. Find a leaf in your garden. Make rubbings of it in your homework book to form a pattern.

LESSON 32: 2-D SHAPES – RECOGNITION

Teacher's notes

CAPS topics: 1.2 Count forwards and backwards, 1.16 Mental mathematics, 3.3 2-D shapes.

Lesson vocabulary: Forwards, backwards, 2-D shape, circles, triangles, squares, recognise, name.

Prior knowledge: Learners should have been taught how to:

- Recognise, identify and read number symbols **0** to **80**.
- Count out objects reliably to 40.
- Recognise and name 2-D shapes: circles, triangles, squares.
- Describe, sort and compare 2-D shapes in terms of: size, colour, straight sides, round sides.

Concepts:

- Recognise and name 2-D shapes: circles, triangles, squares.

Resources: Pictures of different squares, circles and triangles (see *Printable Resources*), whiteboards/scrap paper.

DBE workbook activities relevant to this lesson:

- DBE Worksheet 109 (pp. 90 and 91).

Assessment: Refer to the tracker for today's formal/informal oral, practical or written assessment activity.

Remediation: Give learners shapes (triangles, squares and circles) of various sizes. Help learners to sort the shapes according to their shape. Ask learners to show you a square. Ask them to describe the shape to you. (Four sides, sides are straight.) Ask learners to show you a circle. Ask them to describe the shape to you. (Round, no straight sides.) Ask learners to show you a triangle. Ask them to describe the shape to you. (Three sides, sides are straight.)

Enrichment: See enrichment activity cards.

1. Mental mathematics

1.1 Counting (5 minutes)

- Count forwards and backwards in ones from 0 and 100, starting from any number.
E.g. forwards 42, 43, 44...
backwards 81, 80, 79...

1.2 Mental mathematics activity (10 minutes)

	Complete the following:	Answer
1.	$4 + 5 + 1 = \underline{\quad}$	10
2.	$2 + 1 + 4 = \underline{\quad}$	7
3.	$3 + 3 + 3 = \underline{\quad}$	9
4.	$1 + 5 + 1 = \underline{\quad}$	7
5.	$2 + 2 + 2 = \underline{\quad}$	6

	Complete the following:	Answer
6.	$4 + 4 + 1 = \underline{\quad}$	9
7.	$5 + 5 + 0 = \underline{\quad}$	10
8.	$2 + 3 + 4 = \underline{\quad}$	9
9.	$3 + 2 + 3 = \underline{\quad}$	8
10.	$4 + 3 + 2 = \underline{\quad}$	9

2. Correction/reflection on homework (15 minutes)

- Reflection/remediation based on previous day's work/homework.

3. Lesson content – concept development (30 minutes)

There are three lessons this term on 2-D shapes. Remember to have plenty of paper or plastic examples of the different 2-D shapes to bring to the lesson. It is very important for learners to work with real examples of 2-D shapes while they are learning about them. The focus of this lesson is the nature of the shapes in terms of number of sides and you should make sure that learners are able to recognize and name the 2-D shapes they work with.

Activity 1: Whole class activity

- Show learners a variety of squares.
- Point to different squares and ask:
 - *What shape is this?* (A square.)
 - *What is the same about these shapes?* (They are all squares, they all have 4 sides.)
 - *What is different about these shapes?* (They are different sizes.)
- Ask learners to draw a square on their whiteboards/scrap paper.

Activity 2: Whole class activity

- Show learners a variety of circles.
- Point to different circles and ask:
 - *What shape is this?* (A circle.)
 - *What is the same about these shapes?* (They are all circles, they are all round.)
 - *What is different about these shapes?* (They are different sizes.)
- Ask learners to draw a circle on their whiteboards/scrap paper.

Activity 3: Whole class activity

- Show learners a variety of triangles.
- Point to different triangles and ask:
 - *What shape is this?* (A triangle.)
 - *What is the same about these shapes?* (They are all triangle, they all have 3 sides.)
 - *What is different about these shapes?* (They are different sizes, they face different ways, the sides are not all the same length.)
- Ask learners to draw a triangle on their whiteboards/scrap paper.
- If there is time, ask learners to draw a house on their whiteboard using circles, squares and triangles.

4. Classwork activity from LAB (25 minutes) (See next page)

5. Homework activity from LAB (5 minutes) (See next page)

6. Reflection on lesson

Term 4 Lesson 32: 2-D shapes – recognition

Classwork

1. Trace the squares, circles and triangles.

a) Trace only the squares.

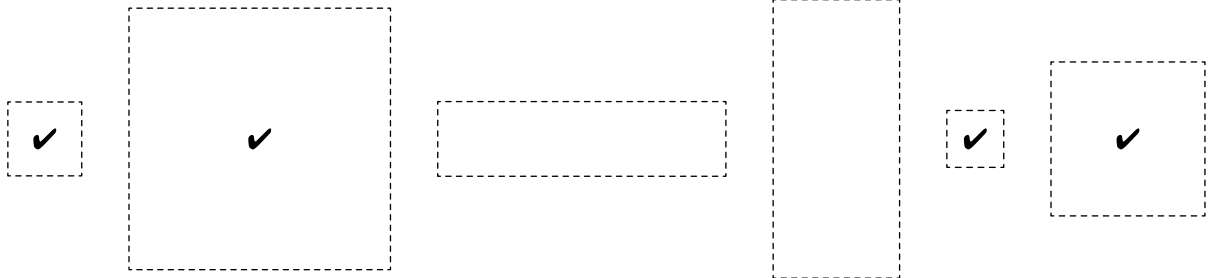

b) Trace only the circles.

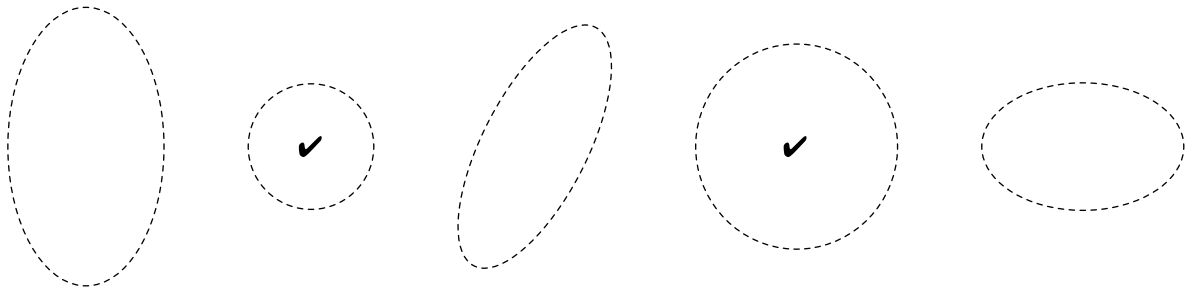

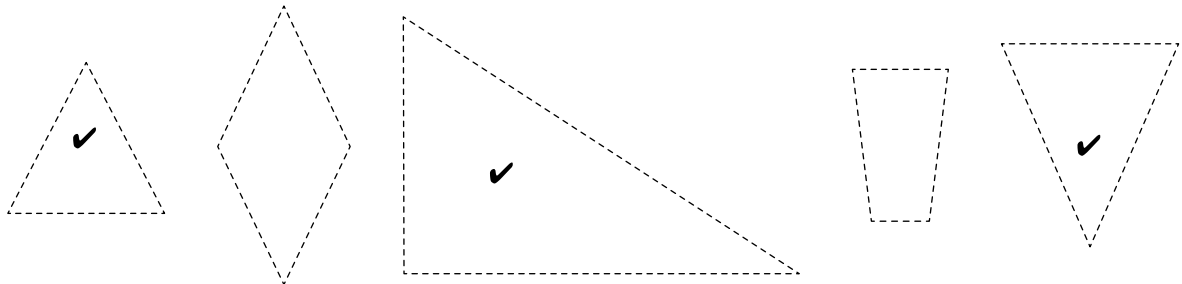

c) Trace only the triangles.



Homework

1. Draw a square. 

2. Draw a circle. 

3. Draw a triangle. 

LESSON 33: 2-D SHAPES – ROUND AND STRAIGHT SIDES

Teacher's notes

CAPS topics: 1.2 Count forwards and backwards, 1.16 Mental mathematics, 3.3 2-D shapes.

Lesson vocabulary: Forwards, backwards, 2-D shapes, circles, triangles, squares, round sides, straight sides, more than, less than, describe, sort, compare, recognise, name.

Prior knowledge: Learners should have been taught how to:

- Recognise, identify and read number symbols **0** to **80**.
- Count out objects reliably to 40.
- Recognise and name 2-D shapes: circles, triangles, squares.
- Describe, sort and compare 2-D shapes in terms of: size, colour, straight sides, round sides.

Concepts:

- Recognise and name 2-D shapes: circles, triangles, squares.
- Describe, sort and compare 2-D shapes in terms of: straight sides, round sides.

Resources: Plastic/paper shapes (triangles, squares and circles – see *Printable Resources*) of various sizes.

DBE workbook activities relevant to this lesson:

- DBE Worksheet 110 (pp. 92 and 93).

Assessment: Refer to the tracker for today's formal/informal oral, practical or written assessment activity.

Remediation: Give learners shapes (triangles, squares and circles) of various sizes. Help learners to sort the shapes according to their sides (straight sides and round sides). Say: *Show me all the shapes with round sides. Show me all the shapes with straight sides.* Ask: *Pick up and name a shape that has straight sides. (Square or triangle.) Pick up and name a shape that has round sides. (Circle.)*

Enrichment: See enrichment activity cards.

1. Mental mathematics

1.1 Counting (5 minutes)

- Count forwards and backwards in ones, twos, fives and tens from 0 and 100.
E.g. forwards 1, 2, 3...; 2, 4, 6...; 5, 10, 15...; 10, 20, 30...
backwards 100, 99, 98...; 100, 98, 96...; 100, 95, 90...; 100, 90, 80...

1.2 Mental mathematics activity (10 minutes)

	Which number is 3 less than...	Answer
1.	5?	2
2.	15?	12
3.	10?	7
4.	3?	0
5.	18?	15

	Which number is 3 more than...	Answer
6.	16?	19
7.	10?	13
8.	7?	10
9.	13?	16
10.	5?	8

2. Correction/reflection on homework (15 minutes)

Reflection/remediation based on previous day's work/homework.

3. Lesson content – concept development (30 minutes)

Activity 1: Learners work in groups

- Give each group of learners some plastic/paper shapes (triangles, squares and circles) of various sizes and colour.
- Ask learners to show you a circle. Learners trace around the circle with their fingers.
- Ask learners: *Does it have straight or round sides?* (Round sides.) You may need to guide the learners at the beginning.
- Ask the learners to draw a shape with round sides in the air.
- Ask learners to show you a triangle. Learners trace around the triangle with their fingers.
- Ask learners: *Does it have straight or round sides?* (Straight sides.) You may need to guide the learners at the beginning.
- Ask the learners to draw a shape with straight sides in the air.
- Ask learners to show you a square. Learners trace around the square with their fingers.
- Ask learners: *Does it have straight or round sides?* (Straight sides.) You may need to guide the learners at the beginning.
- Ask the learners to draw a shape with straight sides in the air.

Activity 2: Learners work in groups

- Ask the learners to place all the shapes in the middle of the table. Ask one learner to close her/his eyes and pick up a shape.
- Learners must guess what shape they have picked up by feeling if the sides are straight or round and when they are straight by counting the number of sides the shape has. They must do this with their eyes closed as it helps them develop their ability to visualise the shapes.
- Ask: *Does the shape have round or straight sides?* (It has straight/round sides.)
- Ask: *Can you name the shape?* (It is a circle/square/triangle.)
- Ask: *How do you know?* (It has ____ sides.)
- After learners have all had a chance to visualise the shapes, summarise the findings in a whole class discussion.
- Say: *Pick up a square. How many sides does it have?* (4 straight sides.)
- Say: *Pick up a triangle. How many sides does it have?* (3 straight sides.)
- Say: *Pick up a circle. Does it have straight sides?* (No, it has a round side.)
- Make sure that all learners have a chance to feel the shapes and talk about them.

4. Classwork activity from LAB (25 minutes) (See next page)







5. Homework activity from LAB (5 minutes) (See next page)

6. Reflection on lesson

Term 4 Lesson 33: 2-D shapes – round and straight sides

Classwork



1. Trace the following shapes.

 Triangle	 Circle	 Square
 Triangle	 Circle	 Square

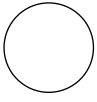
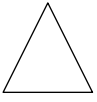
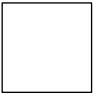
2. Does the shape have round or straight sides?



a) 	b) 	c) 
(round sides)	(straight sides)	(straight sides)

3. Draw a shape with:

- 3 straight sides. ( triangle.)
- Round sides. ( circle.)
- Name your shapes.

Homework

Draw a shape with:

1. 4 straight sides. ( or )

2. What is the name of the shape you drew? (Square or rectangle.)

(Note: CAPS does not specify rectangles in Grade 1 but you could accept it if learners know the shape.)

LESSON 34: 2-D SHAPES – SIZE AND COLOUR

Teacher's notes

CAPS topics: 1.2 Count forwards and backwards, 1.16 Mental mathematics, 3.3 2-D shapes.

Lesson vocabulary: Forwards, backwards, 2-D shapes, circles, triangles, squares, big, small, round, straight, colours, red, blue, green, yellow, smaller, bigger, recognise, name (shape), describe, sort, compare.

Prior knowledge: Learners should have been taught how to:

- Recognise, identify and read number symbols **0** to **80**.
- Count out objects reliably to 40.
- Recognise and name 2-D shapes: circles, triangles, squares.
- Describe, sort and compare 2-D shapes in terms of: size, colour, straight sides, round sides.

Concepts:

- Recognise and name 2-D shapes: circles, triangles, squares.
- Describe, sort and compare 2-D shapes in terms of: size, colour.

Resources: Paper/plastic shapes (triangles, squares and circles) of various sizes and colour, paper, crayons.

DBE workbook activities relevant to this lesson:

- DBE Worksheet 111 (pp. 94 and 95).

Assessment: Refer to the tracker for today's formal/informal oral, practical or written assessment activity.

Remediation: Give learners shapes (triangles, squares and circles) of various sizes and colours. Help learners to sort the shapes. *How did you know to put all those shapes together?* (They all have 3 sides/they all have 4 sides/they are all round.) Help learners to sort the shapes according to size. *Why did you put all those shapes together?* (They are all small/big/medium sized.) Help learners to sort the shapes according to colour. *Why did you put all those shapes together?* (They are all blue/red/yellow.)

Enrichment: See enrichment activity cards.

1. Mental mathematics

1.1 Counting (5 minutes)

- Count forwards and backwards in ones, twos, fives and tens from 0 and 100.
 E.g. forwards 1, 2, 3..., 2, 4, 6..., 5, 10, 15..., 10, 20, 30...
 backwards 100, 99, 98..., 100, 98, 96..., 100, 95, 90..., 100, 90, 80...

1.2 Mental mathematics activity (10 minutes)

	Complete the following:	Answer
1.	$7 + 3 + 1 = \underline{\quad}$	11
2.	$8 + 2 + 3 = \underline{\quad}$	13
3.	$4 + 4 + 4 = \underline{\quad}$	12
4.	$9 + 5 + 1 = \underline{\quad}$	15
5.	$10 + 3 + 3 = \underline{\quad}$	16

	Complete the following:	Answer
6.	$6 + 6 + 4 = \underline{\quad}$	16
7.	$7 + 8 + 2 = \underline{\quad}$	17
8.	$2 + 10 + 1 = \underline{\quad}$	13
9.	$4 + 9 + 1 = \underline{\quad}$	14
10.	$10 + 10 + 0 = \underline{\quad}$	20

2. Correction/reflection on homework (15 minutes)

Reflection/remediation based on previous day's work/homework.

3. Lesson content – concept development (30 minutes)

In this lesson on 2-D shapes (which is the last lesson for the year on shapes) learners are called on to differentiate between shapes according to their type, size and colour.

Activity 1: Learners work in groups

- Give each group of learners some plastic/paper shapes (triangles, squares and circles) of various sizes, shapes and colours.
- Ask learners to sort the shapes.
 - *Show me all the triangles.*
 - *Show me all the squares.*
 - *Show me all the circles.*
- Ask learners to sort the shapes according to size.
 - *Show me all the big triangles.*
 - *Show me all the big squares.*
 - *Show me all the big circles.*
- Ask learners to sort the shapes according to colour.
 - *Show me the blue shapes.*
 - *Show me all the red shapes.*
 - *Show me all the yellow shapes.*

Activity 2: Whole class activity

- Give the learners a piece of paper. Ask the learners to listen to each of your instructions and then draw the shape.
 - *Draw a big triangle. Draw a small triangle. Draw a red triangle.*
 - *Draw a big square. Draw a small square. Draw a yellow square.*
 - *Draw a big circle. Draw a small circle. Draw a blue circle.*
- Discuss the different shapes they have drawn. Talk about the colour, type and size of shape.

4. Classwork activity from LAB (25 minutes) (See next page)

5. Homework activity from LAB (5 minutes) (See next page)

6. Reflection on lesson

Term 4 Lesson 34: 2-D shapes – size and colour

Classwork

1. Circle the smallest shape.

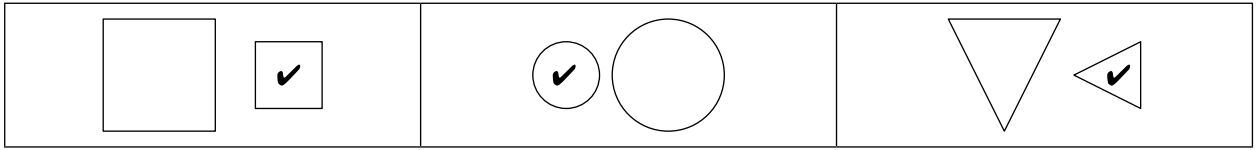

2. Circle the largest shape.

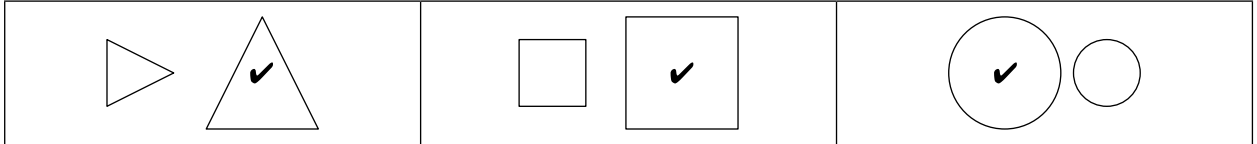

3. Colour all the squares red, triangles yellow and circles green.

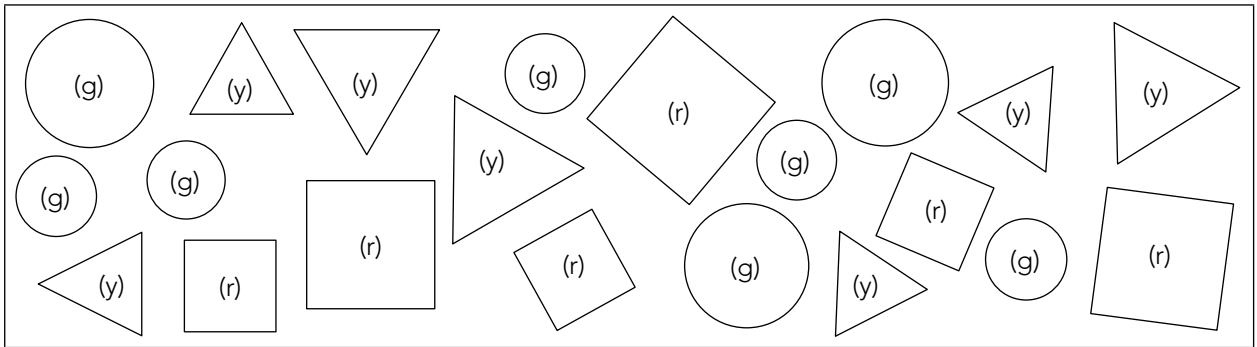

Homework

Make a picture using circles, triangles and squares.

WEEK 8

LESSON 35: SYMMETRY

Teacher's notes

CAPS topics: 1.2 Count forwards and backwards, 1.16 Mental mathematics, 3.4 Symmetry.

Lesson vocabulary: Forwards, backwards, 2-D shapes, line of symmetry, the same, symmetrical, geometrical shape, non-geometrical shape, horizontal, vertical, recognise.

Prior knowledge: Learners should have been taught how to:

- Recognise, identify and read number symbols **0** to **80**.
- Count out objects reliably to 40.
- Recognise symmetry in own bodies.
- Recognise and draw line of symmetry in 2-D geometrical and non-geometrical shapes.

Concepts:

- Recognise and draw line of symmetry in 2-D geometrical and non-geometrical shapes.

Resources: Large simple butterfly and small paper shapes (circles, triangles and squares – see *Printable Resources*), whiteboards/scrap paper.

DBE workbook activities relevant to this lesson:

- DBE Worksheet 128 (pp. 128 and 129).

Assessment: Refer to the tracker for today's formal/informal oral, practical or written assessment activity.

Remediation: Give the learners a cut-out shape, e.g. a square or circle. Ask them to fold the shape so that the two sides fit exactly on top of each other. They then open it up and draw the line of symmetry along the fold.

Enrichment: See enrichment activity cards.

1. Mental mathematics

1.1 Counting (5 minutes)

- Count forwards and backwards in ones, twos, fives and tens from 0 and 100.
E.g. forwards 1, 2, 3..., 2, 4, 6..., 5, 10, 15..., 10, 20, 30...
backwards 100, 99, 98..., 100, 98, 96..., 100, 95, 90..., 100, 90, 80...

1.2 Mental mathematics activity (10 minutes)

	Complete the following:	Answer
1.	$4 + \underline{\quad} = 8$	4
2.	$3 + \underline{\quad} = 10$	7
3.	$2 + \underline{\quad} = 7$	5
4.	$3 + \underline{\quad} = 6$	3
5.	$1 + \underline{\quad} = 9$	8

	Complete the following:	Answer
6.	$2 + \underline{\quad} = 6$	4
7.	$5 + \underline{\quad} = 8$	3
8.	$7 + \underline{\quad} = 9$	2
9.	$6 + \underline{\quad} = 10$	4
10.	$4 + \underline{\quad} = 5$	1

2. Correction/reflection on homework (15 minutes)

Reflection/remediation based on previous day's work/homework.

3. Lesson content – concept development (30 minutes)

This is the second lesson on the concept of symmetry in Grade 1. You should take time to revise the concept and vocabulary of symmetry (and related 2-D shapes in which symmetry is discussed). Be sure to refer to the *Jika iMfundo* dictionary if you need to for definitions and examples of the vocabulary used in this lesson.

If you are not able to print the butterfly and small shapes for this activity, you could draw a large symmetrical butterfly on the board and get the learners to copy it onto their whiteboards/scrap paper and decorate it in a way that the wings are symmetrical.

Activity 1: Learners work in groups

- Give each group of learners a picture of a butterfly or another symmetrical shape – the example provided in the printable resources is a butterfly.
- Ask the learners to cut out the butterfly/symmetrical shape and fold it so that the two sides fit exactly on top of each other.
- Ask learners to then open it.
- Ask the learners to draw a dotted line where the fold is.
- *This is the line of symmetry. Both sides of the shape on either side of the line of symmetry match exactly.*

Activity 2: Learners work in groups

- Give each group of learners some small, equal-sized shapes (circles, squares and triangles) to place on the shape. (These are provided in the *Printable Resources* but you need to cut them out before the lesson or give learners time to cut them out in the lesson.)
- Ask them to place shapes on the one side of the butterfly template.
- They must then place/draw shapes on the other side of the butterfly so that there is a symmetrical pattern on the other side.

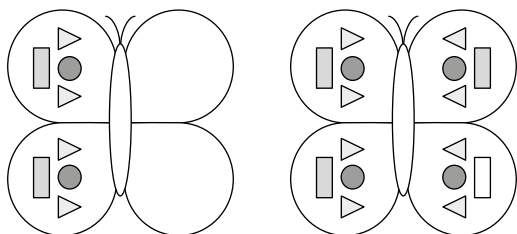

- Share some of the learners drawings with the class. Point out to the learners that the line of symmetry in the butterfly is a vertical line.

Activity 3: Whole class activity

- Say: *The line of symmetry is not necessarily always a vertical line.*
- Draw some shapes which will have a horizontal line of symmetry on the board. E.g.

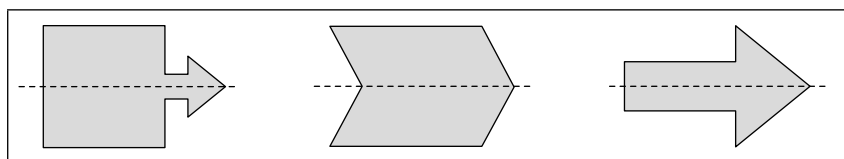

- First draw the shape without the line of symmetry. Work with the class to identify where the line of symmetry should be drawn and then draw them in.
- Discuss the nature of the line of symmetry: *Both sides of the shape on either side of the line of symmetry match exactly.*

4. Classwork activity from LAB (25 minutes) (See next page)

5. Homework activity from LAB (5 minutes) (See next page)

6. Reflection on lesson

Term 4 Lesson 35: Symmetry

Classwork

1. Draw a line of symmetry for each picture. Colour your pictures.

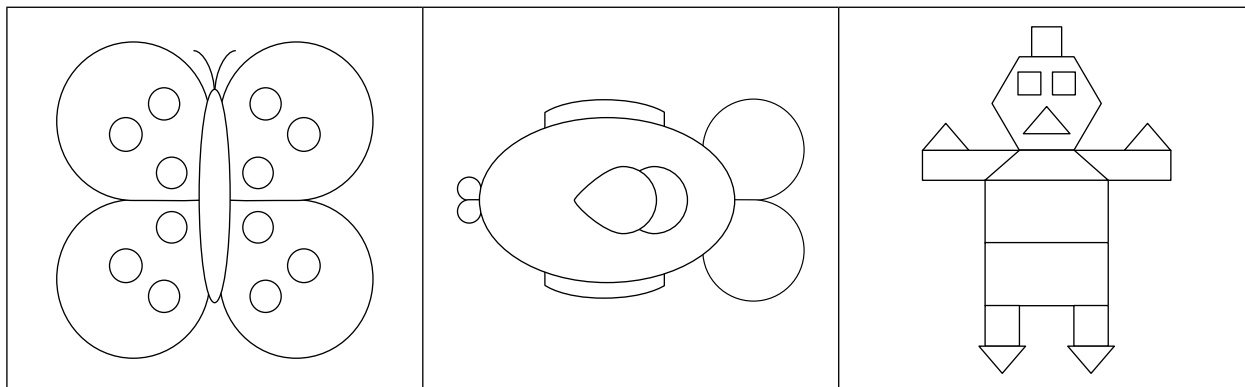

2. Complete each picture by drawing the other half. Colour your pictures.

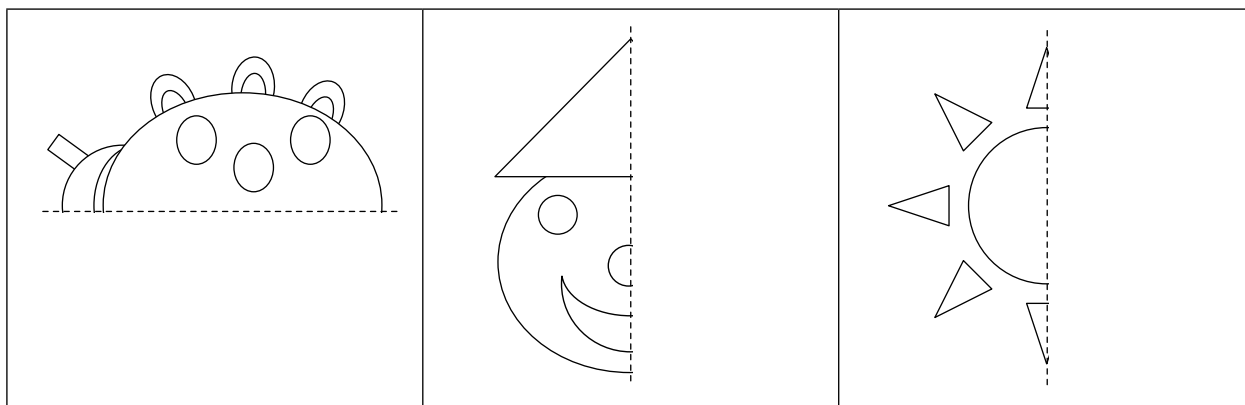

Homework

1. Draw a line of symmetry.

2. Draw the other half of the picture.

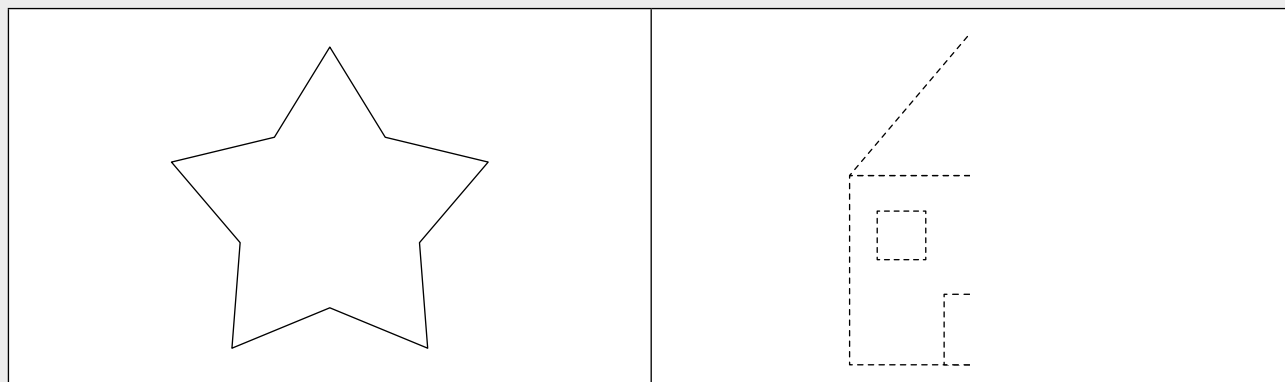

LESSON 36: DOUBLING

Teacher's notes

CAPS topics: 1.1 Count objects, 1.2 Count forwards and backwards, 1.16 Mental mathematics, 1.6 Problem solving techniques, 1.12 Techniques (methods or strategies)

Lesson vocabulary: Forwards, backwards, how many, double, the same, plus, more than, less than, doubling, addition, add.

Prior knowledge: Learners should have been taught how to:

- Recognise, identify and read number symbols **0** to **80**.
- Count out objects reliably to 40.
- Solve problems using concrete apparatus and pictures and explain solutions to problems involving addition with answers up to fifteen.
- Use appropriate symbols (+, -, =).
- Use doubling as a technique when solving problems.

Concepts:

- Use doubling as a technique when solving problems.
- Solve problems using concrete apparatus and pictures and explain solutions to problems involving addition with answers up to twenty.

Resources: Counters, whiteboards/scrap paper, pictures/drawings (hand, bicycles, tricycles, beetles, calendar week – find your own).

DBE workbook activities relevant to this lesson:

- DBE Worksheet 122 (pp. 116 and 117).

Assessment: Refer to the tracker for today's formal/informal oral, practical or written assessment activity.

Remediation: Ask the learners to draw 2 counters. Ask them to then draw another two. Say: *Now we have double two which is 4.* Do the same with 3, 4, 5, 6, 7, 8, 9, and 10.

Enrichment: See enrichment activity cards.

1. Mental mathematics

1.1 Counting (5 minutes)

- Count forwards and backwards in ones, twos, fives and tens from 0 and 100.
E.g. forwards 1, 2, 3..., 2, 4, 6..., 5, 10, 15..., 10, 20, 30...
backwards 100, 99, 98..., 100, 98, 96..., 100, 95, 90..., 100, 90, 80...

1.2 Mental mathematics activity (10 minutes)

	Question	Answer
1.	What is 3 less than 19?	16
2.	What is 3 more than 7?	10
3.	Complete: $4 + \underline{\quad} = 8$	4
4.	Complete: $5 + \underline{\quad} = 9$	4
5.	Add: $2 + 1 + 6 = \underline{\quad}$	9

	Question	Answer
6.	What is 3 less than 12?	9
7.	What is 3 more than 15?	18
8.	Complete: $3 + \underline{\quad} = 10$	7
9.	Complete: $6 + \underline{\quad} = 7$	1
10.	Add: $8 + 1 + 1 = \underline{\quad}$	10

2. Correction/reflection on homework (15 minutes)

- Reflection/remediation based on previous day's work/homework.

3. Lesson content – concept development (30 minutes)

This lesson and the next lesson consolidate learners' understanding of the operations of multiplication and division by focusing specifically on doubling and halving. This is a final opportunity for the year to spend time doing some number and operations work with the class.

Activity 1: Whole class activity

- Show the learners the pictures mentioned below or draw them on the board and say the following:
- *How many fingers do we have on one hand?* (5)
- *How many fingers do we have on two hands?* (10)
- *We can say: Double 5 is 10.*
- Do the same with pictures of:
 - a bicycle (2 wheels – double 2)
 - a tricycle (3 wheels – double 3)
 - a car (4 wheels – double 4)
 - a beetle (6 legs – double 6)
 - a week on the calendar (7 days – double 7).

Activity 2: Learners work in groups

- Give each group of learners 20 counters.
- Ask the learners to show you a group of five counters. ○○○○○
- Ask them to show you another group of five counters. ○○○○○ ○○○○○
- Say: *Double 5 is 10 counters.*
- Do the same with 6, 7, 8, 9 and 10 counters.

Activity 3: Whole class activity

- Draw 11 counters on the board and ask the learners to draw the same on their whiteboards/scrap paper.
○○○○○○○○○○○○○
- Ask them to colour 5 counters.
●●●●●○○○○○
- Ask them to colour 5 more counters.
●●●●●○○○○○
- Say: *You have doubled 5 and you have one more.*
- So we can write $5 + 5 + 1 = 11$
- Do the same with 13, 15, 17 and 19 counters.

4. Classwork activity from LAB (25 minutes) (See next page)

5. Homework activity from LAB (5 minutes) (See next page)

6. Reflection on lesson

Term 4 Lesson 36: Doubling

Classwork

1.

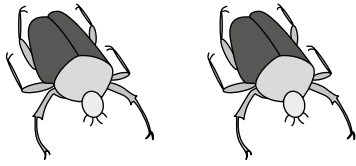

- a) How many legs does one beetle have? (6)
- b) How many legs do two beetles have? (12)

2.

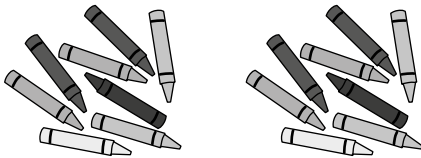

- a) How many crayons are there in one set? (8)
- b) How many crayons are there in two sets? (16)

3. Answer the following. Draw counters to help you.

- a) Double 9 is __ (18)
- b) Double 10 is __ (20)
- c) Double 8 is __ (16)

4. $7 + 7 + 1 = \underline{\quad}$ (15)

5. Double $7 + 1 = \underline{\quad}$ (15)

Homework

- 1. Double 5 is __ (10)
- 2. Double 7 is __ (14)
- 3. $8 + 8 + 1 = \underline{\quad}$ (17)
- 4. Double $8 + 1 = \underline{\quad}$ (17)

LESSON 37: HALVING

Teacher's notes

CAPS topics: 1.1 Count objects, 1.2 Count forwards and backwards, 1.16 Mental mathematics, 1.6 Problem solving techniques, 1.12 Techniques (methods or strategies).

Lesson vocabulary: Forwards, backwards, how many, the same, half, halving.

Prior knowledge: Learners should have been taught how to:

- Recognise, identify and read number symbols **0** to **80**.
- Solve problems using concrete apparatus and pictures and explain solutions to problems involving addition with answers up to fifteen.
- Use appropriate symbols (+, -, =).
- Use halving as a technique when solving problems.

Concepts:

- Use halving as a technique when solving problems.
- Solve problems using concrete apparatus and pictures and explain solutions to problems involving addition with answers up to twenty.

Resources: Counters, whiteboards/scrap paper, pictures/drawings (hand, bicycles, tricycles, beetles, calendar week – find your own).

DBE workbook activities relevant to this lesson:

- DBE Worksheet 123 (pp. 118 and 119).

Assessment: Refer to the tracker for today's formal/informal oral, practical or written assessment activity.

Remediation: Ask the learners to draw 10 counters. (○○○○○○○○○○○○) Ask them to then draw a line down the middle to make two equal parts. (○○○○○|○○○○○) Say: *Now we have half on each side and half of 10 is 5.* Do the same with 12, 14, 16, 18 and 20.

Enrichment: See enrichment activity cards.

1. Mental mathematics

1.1 Counting (5 minutes)

- Count forwards and backwards in ones, twos, fives and tens from 0 and 100.
E.g. forwards 1, 2, 3..., 2, 4, 6..., 5, 10, 15..., 10, 20, 30...
backwards 100, 99, 98..., 100, 98, 96..., 100, 95, 90..., 100, 90, 80...

1.2 Mental mathematics activity (10 minutes)

	Complete the following:	Answer
1.	$7 - 1 - 1 = \underline{\quad}$	5
2.	$9 - 2 - 3 = \underline{\quad}$	4
3.	$8 - 6 - 1 = \underline{\quad}$	1
4.	$9 - 4 - 2 = \underline{\quad}$	3
5.	$7 - 3 - 3 = \underline{\quad}$	1

	Complete the following:	Answer
6.	$10 - 5 - 2 = \underline{\quad}$	3
7.	$7 - 6 - 1 = \underline{\quad}$	0
8.	$8 - 4 - 3 = \underline{\quad}$	1
9.	$6 - 1 - 1 = \underline{\quad}$	4
10.	$10 - 2 - 2 = \underline{\quad}$	6

2. Correction/reflection on homework (15 minutes)

- Reflection/remediation based on previous day's work/homework.

3. Lesson content – concept development (30 minutes)

Activity 1: Whole class activity

- Ask the learners to draw a group of ten counters on their whiteboards/scrap paper.
- Ask them to colour in half of the counters. ○○○○○○○○○○○
- Ask the learners: *How did you know how many to colour in?* (The same number had to be coloured in as not coloured in.)
- Say: *Half of 10 is 5.*
- Do the same with 12, 14, 16, 18 and 20 counters.

Activity 2: Whole class activity

- Show the learners the pictures mentioned below or draw them on the board and ask the following:
- *How many fingers do we have on two hands?* (10)
- *If we take one hand away, how many fingers will we have?* (5)
- We can say: *Half of 10 is 5.*
- Do the same with pictures of:
 - two bicycles (4 wheels on 2 bicycles – half of 4 is 2 – 2 wheels on one bicycle.)
 - two tricycles (6 wheels on 2 tricycles – half of 6 is 3 – 3 wheels on 1 tricycle.)
 - two cars (8 wheels on two cars – half of 8 is 4 – 4 wheels on one car.)
 - two beetles (12 legs on two beetles – half of 12 is 6 – 6 legs on one beetle.)
 - two weeks on the calendar (14 days in 2 weeks – half of 14 is 7 – 7 days in one week.)

4. Classwork activity from LAB (25 minutes) (See next page)

5. Homework activity from LAB (5 minutes) (See next page)

6. Reflection on lesson

Term 4 Lesson 37: Halving

Classwork

1. Use the beetles to help you calculate half:

- a) Half of 12 is __ (6)
- b) Half of 16 is __ (8)
- c) Half of 20 is __ (10)
- d) Half of 14 is __ (7)

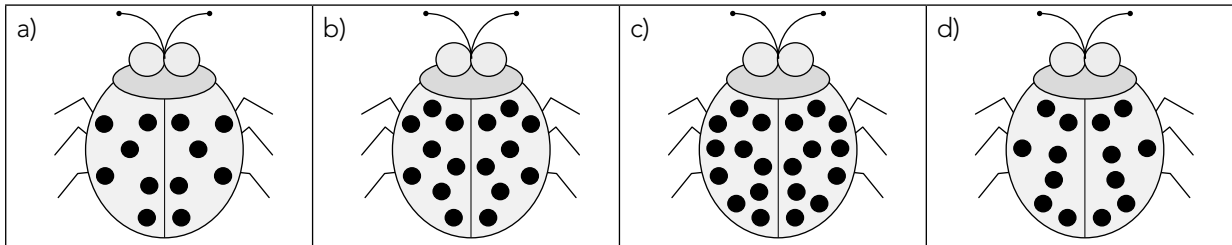

2. Use the blocks to help you calculate half:

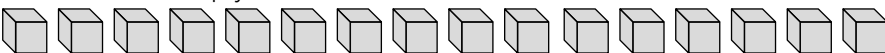
- a) 
Half of 16 is __ (8)

- b) 
Half of 20 is __ (10)

- c) 
Half of 18 is __ (9)

- d) 
Half of 10 is __ (5)

3. Complete the following:

- a) Half of 8 is __ (4)
- b) Half of 12 is __ (6)
- c) Half of 2 is __ (1)
- d) Half of 4 is __ (2)

Homework

1. Use the blocks to help you calculate half:

- a) 
Half of 14 is __ (7)

- b) 
Half of 12 is __ (6)

2. Complete the following:

- a) Half of 10 is __ (5)
- b) Half of 6 is __ (3)

LESSON 38: TIME

Teacher's notes

CAPS topics: 1.2 Count forwards and backwards, 1.16 Mental mathematics, 4.1 Time.

Lesson vocabulary: Forwards, backwards, time, sequence, before, after, next, days of the week, months of the year, month, add, subtract, half, double, between, today, yesterday, tomorrow.

Prior knowledge: Learners should have been taught how to:

- Recognise, identify and read number symbols **0** to **80**.
- Talk about the passing of time by ordering regular events from their own lives.
- Compare lengths of time using language, e.g. longer, shorter, faster, slower.
- Sequence events such as yesterday, today and tomorrow.
- Use language to describe when something happens, e.g. morning, afternoon, night, early, late.
- Name and sequence days of the week and months of the year.
- Place birthdays on a calendar.

Concepts:

- Name and sequence days of the week and months of the year.

Resources: Cards with the names of the days of the week and the names of the months of the year (see *Printable Resources*).

DBE workbook activities relevant to this lesson:

- N/A

Assessment: Refer to the tracker for today's formal/informal oral, practical or written assessment activity.

Remediation: Give the learners cards with the names of the months of the year printed on them. Help them to read the names of the months of the year. Then help them to place the cards in the correct order. *Which month comes after January? Which month comes before March? Which month comes between May and July?* etc. Show the learners how to use the ordered cards to help them work out the correct answer.

Enrichment: See enrichment activity cards.

1. Mental mathematics

1.1 Counting (5 minutes)

- Count forwards and backwards in ones, twos, fives and tens from 0 and 100.
E.g. forwards 1, 2, 3..., 2, 4, 6..., 5, 10, 15..., 10, 20, 30...
backwards 100, 99, 98..., 100, 98, 96..., 100, 95, 90..., 100, 90, 80...

1.2 Mental mathematics activity (10 minutes)

	Complete the following:	Answer
1.	Add: $8 + 1 = \underline{\quad}$	9
2.	Subtract: $9 - 1 - 1 = \underline{\quad}$	7
3.	How many jumps from 13 to 16?	3
4.	Half of 20?	10
5.	Double 6?	12

	Complete the following:	Answer
6.	Add: $3 + 3 = \underline{\quad}$	6
7.	Subtract: $7 - 3 - 1 = \underline{\quad}$	3
8.	How many jumps back from 17 to 15?	2
9.	Half of 14?	7
10.	Double 3?	6

2. Correction/reflection on homework (15 minutes)

Reflection/remediation based on previous day's work/homework.

3. Lesson content – concept development (30 minutes)

This lesson allows you the opportunity to revise the names of the days of the week and the months of the year with the learners. You can use the context of this lesson to discuss events of the year (relating them to days of the week and months of the year) as your closing lesson of the year.

Activity 1: Whole class activity

- Ask: *What day of the week is it today?* (Today is ____.)
- *What day of the week was yesterday?* (Yesterday was ____.)
- *What day of the week will tomorrow be?* (Tomorrow will be ____.)
- Ask: *What day of the week comes after Monday?* (Tuesday.)
- *What day of the week comes before Friday?* (Thursday.)
- *What day of the week is between Friday and Sunday?* (Saturday.) etc.
- Give each group cards with the names of the days of the week and ask them to place them in order from Sunday to Saturday.

Activity 2: Whole class activity

- Ask: *What month of the year it is?* (e.g. It could be November.)
- *What month was before this month?* (e.g. It could be October.)
- *What month will it be after this month?* (e.g. It could be December.)
- *What month is your birthday in?* (Allow the learners to tell you the months of their birth.)
- Give each group cards with the names of the months of the year and ask them to place them in order from January to December.

Activity 3: Whole class activity

- Ask learners to select a day from the days-of-the-week cards.
- Ask learners to talk about something they typically do on that day of the week.
- Ask learners to select a month from the months-of-the-year cards.
- Ask learners to talk about something special/interesting about that month of the year.

4. Classwork activity from LAB (25 minutes) (See next page)

5. Homework activity from LAB (5 minutes) (See next page)

6. Reflection on lesson

Term 4 Lesson 38: Time

Classwork

1. Fill in the missing words. After that draw a picture in your maths book.
 - a) I started big school in _____. (January)
 - b) I will complete Grade 1 in _____. (December)
2. My favourite month of the year:
 - a) Draw a picture of something you like that happens in one of the months.
 - b) Write the name of the month above your picture.
3. What will you do on Saturday? Draw the picture.

Homework

1. Write **true** or **false**:
 - a) Monday comes after Tuesday. ____ (False)
 - b) March comes before April. ____ (True)
 - c) December is the first month of the year. ____ (False)
 - d) Friday is in between Thursday and Saturday. ____ (True)

PRINTABLE RESOURCES

The following printable resources are included in this section:

1. Resource sheets
2. Mental mathematics challenge cards: Bilingual version
3. Enrichment activity cards: English version
4. Enrichment activity cards: isiZulu version

1. Resource Sheets

This is a list of the mathematical resources that you will need this term. You need to make sure that you have them for the lessons for which they are recommended.

1. Flard cards – tens and units (Lessons 1–5)
2. Ball and box shapes (Lesson 15)
3. Number board 1–100 (Lesson 20)
4. Number line 0–20 (Lesson 20)
5. 5x table number cards (Lesson 21)
6. 2x table number cards (Lesson 21)
7. 10x table number cards (Lesson 21)
8. 2-D shapes – squares (Lesson 32)
9. 2-D shapes – circles (Lesson 32)
10. 2-D shapes – triangles (Lesson 32)
11. 2-D shapes – squares, circles and triangles (Lesson 33)
12. Symmetry pictures (Lesson 35)
13. Days of the week (Lesson 38)
14. Izinsuku zesonto (Isifundo 38)
15. Months of the year (Lesson 38)
16. Izinyanga zonyaka (Isifundo 38)

Resources for each day of teaching

There are also other resources such as informal resources (old magazines, pieces of string, scrap paper, etc.) that you may need in certain lessons. You should have a careful look at the list of resources needed for each lesson; this list is given in the lesson plans each day. Prepare yourself, so that you have the necessary resources for the lessons on a daily basis.

1. Flard cards – tens and units (Lessons 1–5)

1	10
2	20
3	30
4	40
5	50
6	60
7	70
8	80
9	90

2. Ball and box shapes (Lesson 15)

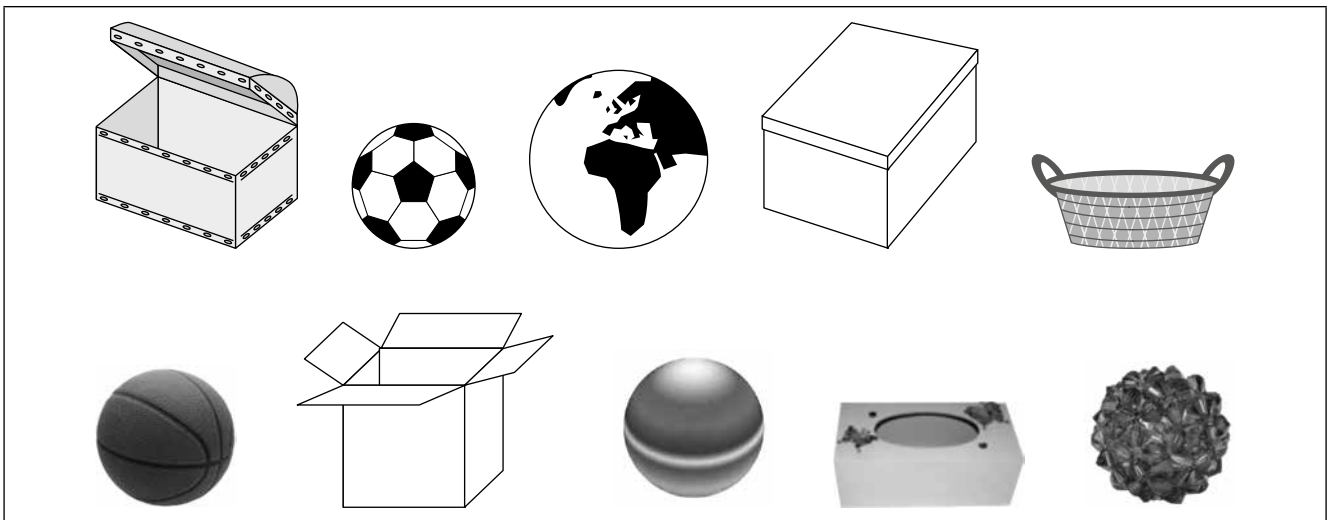
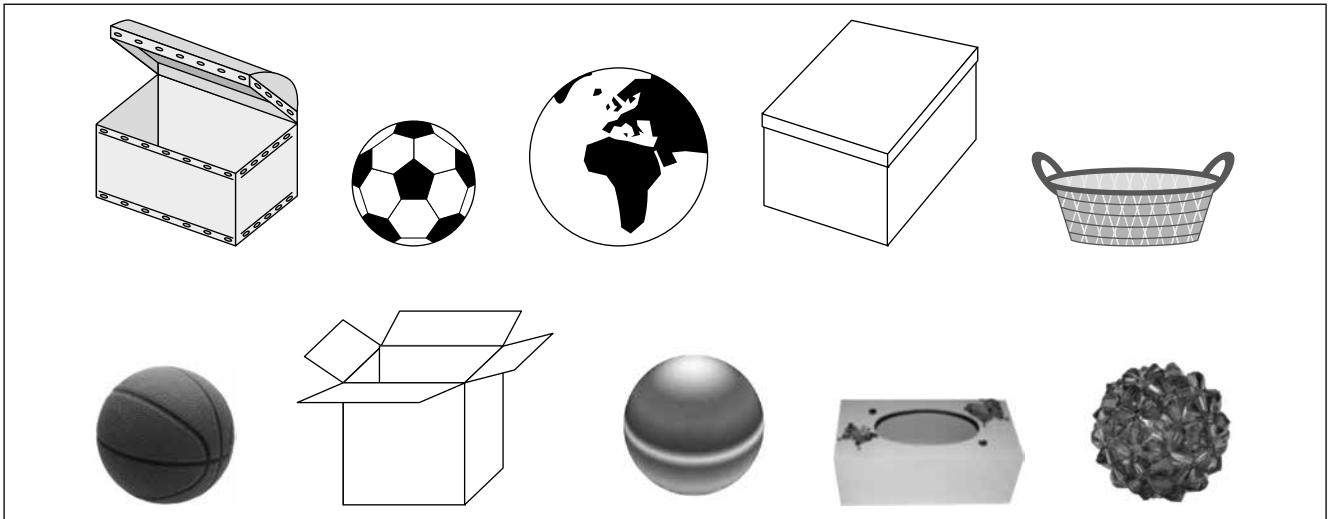
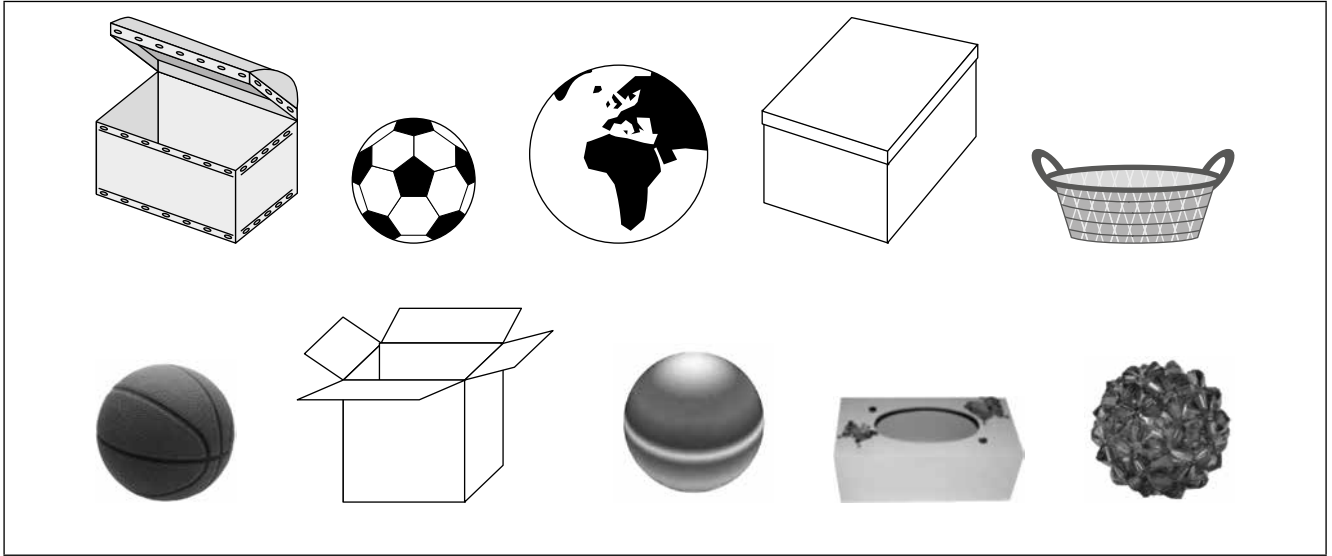

3. Number board 1–100 (Lesson 20)

1	2	3	4	5	6	7	8	9	10
11	12	13	14	15	16	17	18	19	20
21	22	23	24	25	26	27	28	29	30
31	32	33	34	35	36	37	38	39	40
41	42	43	44	45	46	47	48	49	50
51	52	53	54	55	56	57	58	59	60
61	62	63	64	65	66	67	68	69	70
71	72	73	74	75	76	77	78	79	80
81	82	83	84	85	86	87	88	89	90
91	92	93	94	95	96	97	98	99	100

4. Number line 0–20 (Lesson 20)

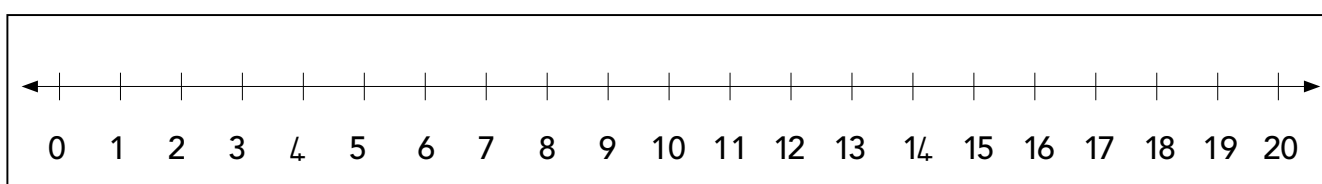
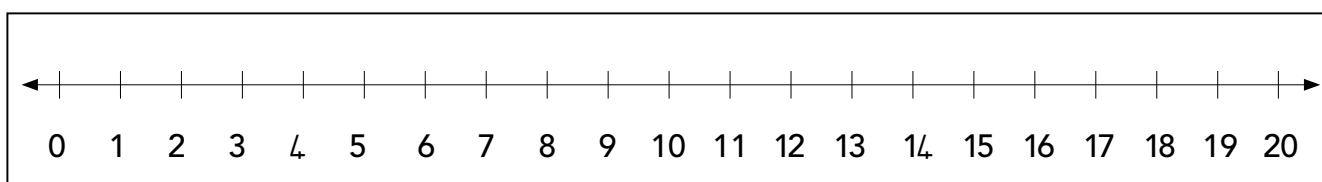
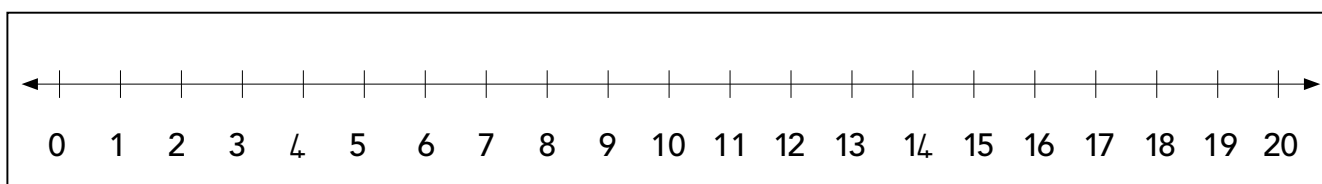
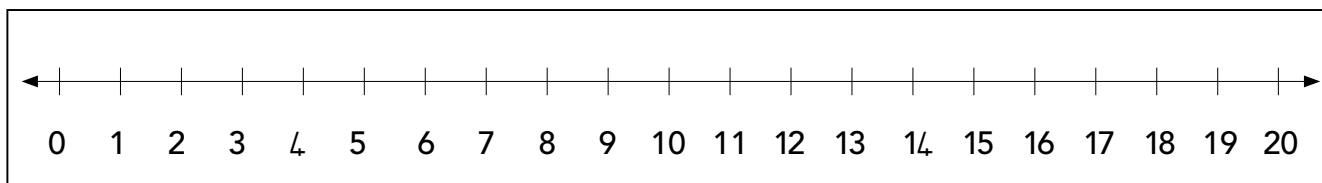
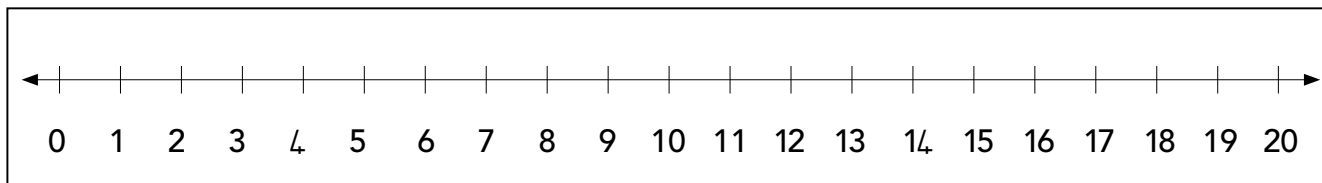

5. 5x table number cards (Lesson 2)

5

10

15

20

25

30

35

40

45

50

55

60

65

70

75

80

85

90

95

100

6. 2x table number cards (Lesson 21)

2	4	6	8	10	12	14
16	18	20	22	24	26	28
30	32	34	36	38	40	42
44	46	48	50	52	54	56
58	60	62	64	66	68	70
72	74	76	78	80	82	84
86	88	90	92	94	96	98
100						

7. 10x table number cards (Lesson 21)

10

20

30

40

50

60

70

80

90

100

8. 2-D shapes – squares (Lesson 32)

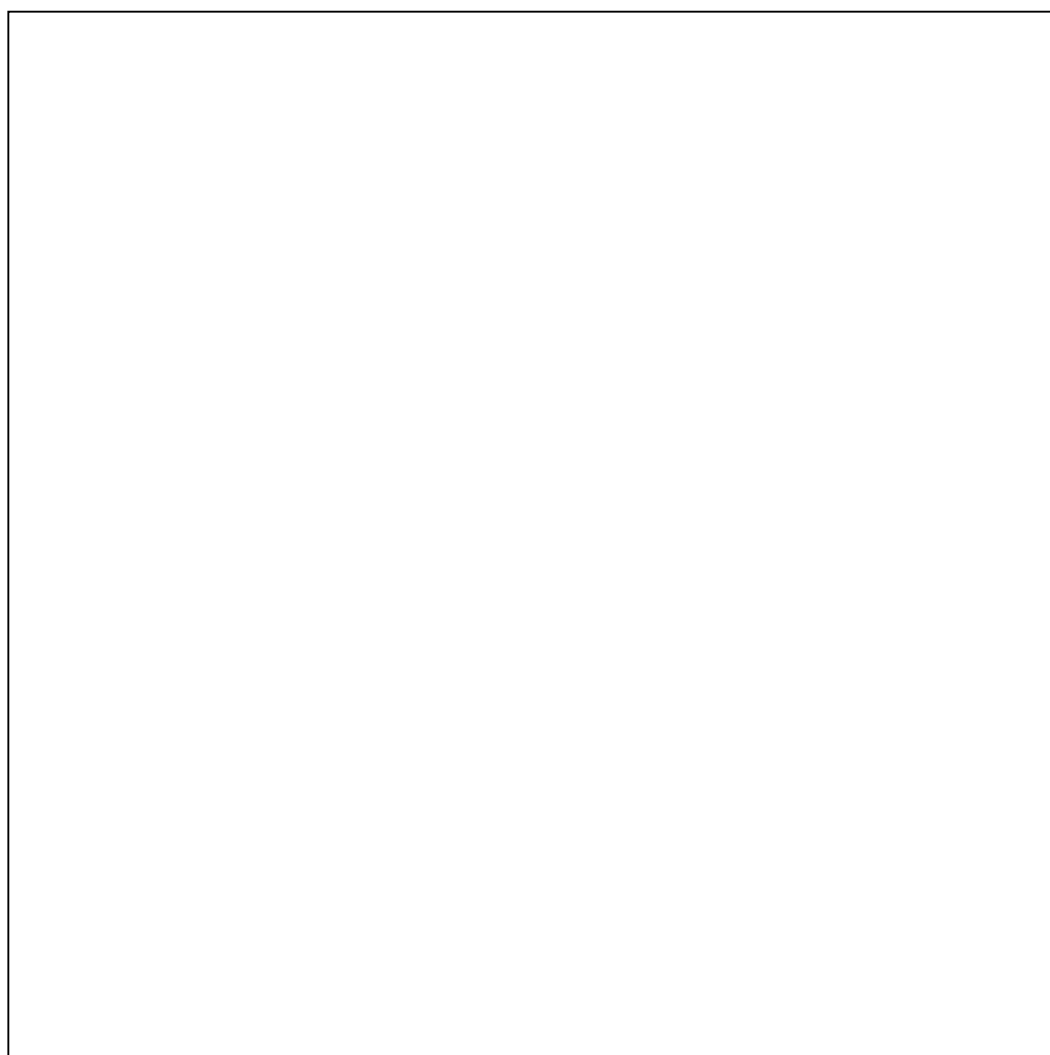
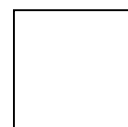
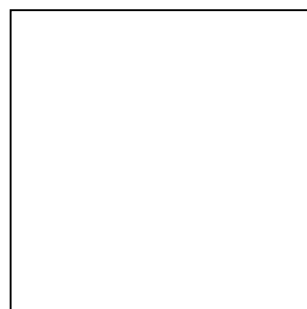
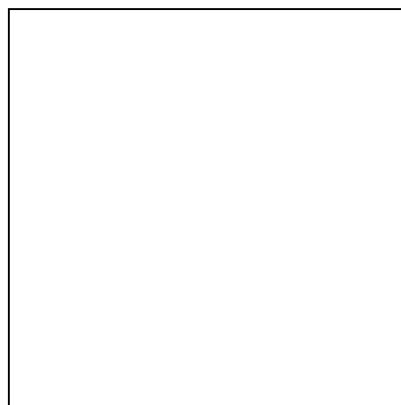
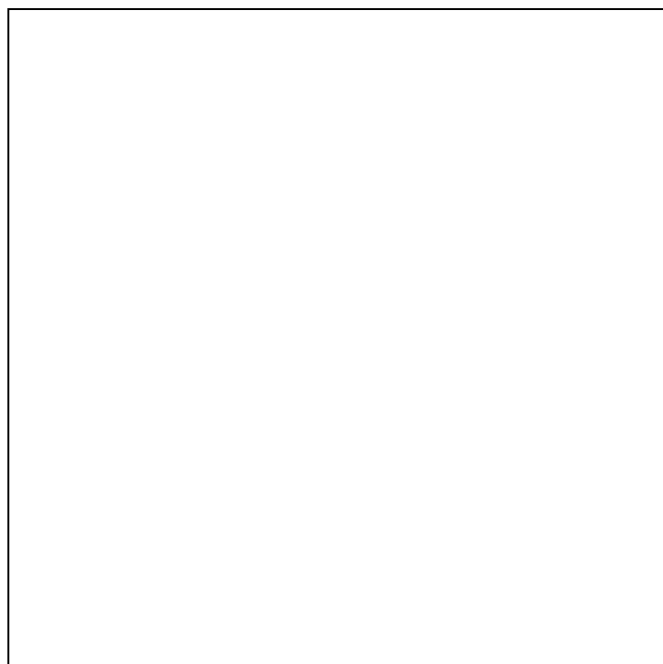

9. 2-D shapes – circles (Lesson 32)

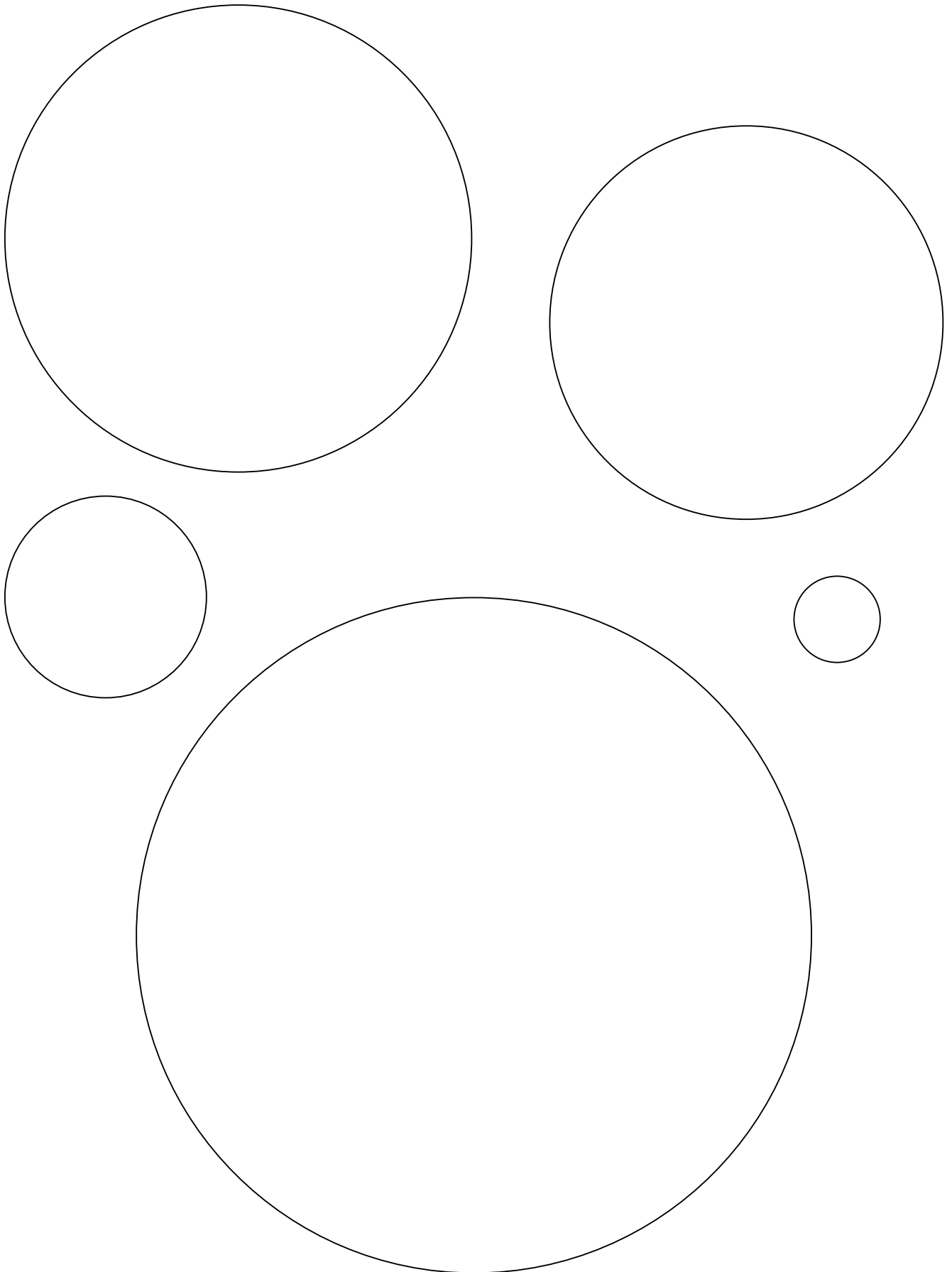

10. 2-D shapes – triangles (Lesson 32)

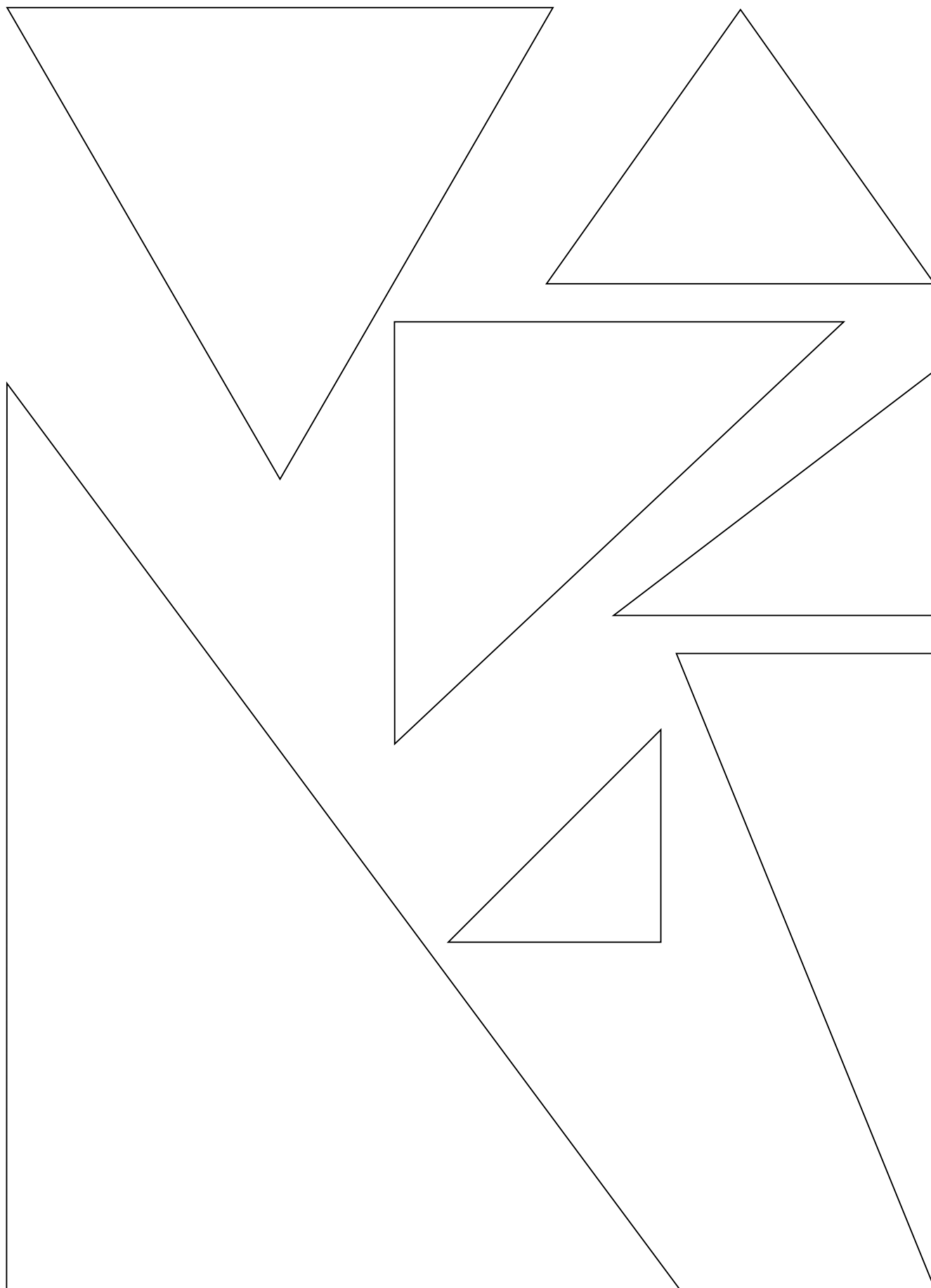

11. 2-D shapes – squares, circles and triangles (Lesson 33)

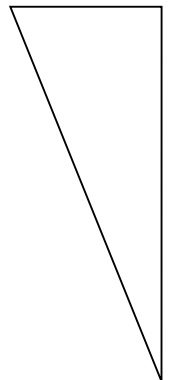
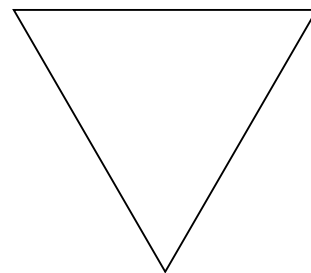
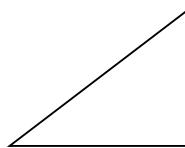
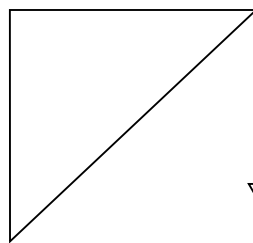
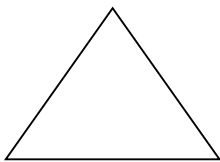
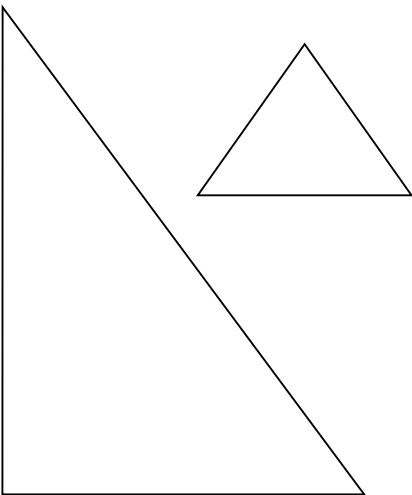
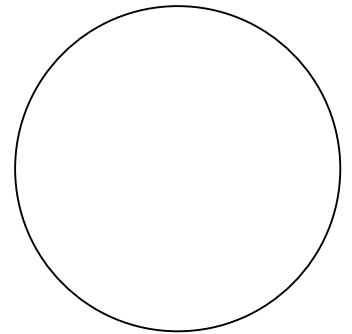
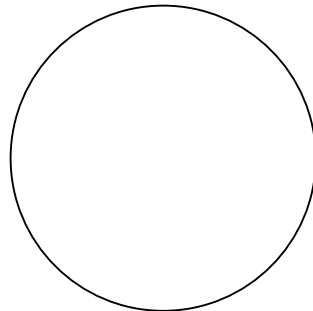
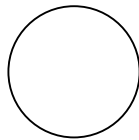
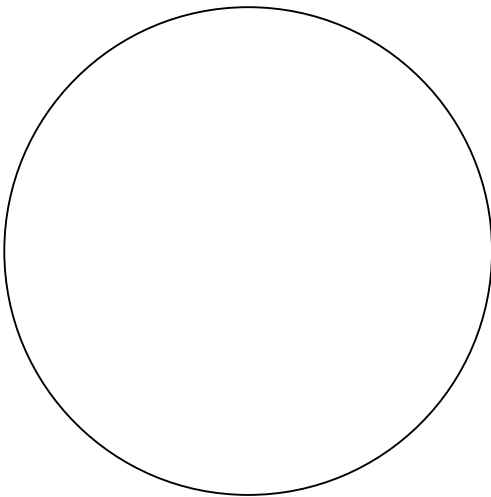
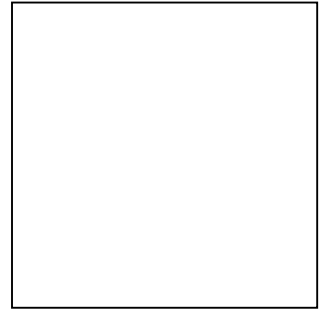
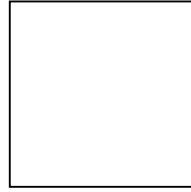
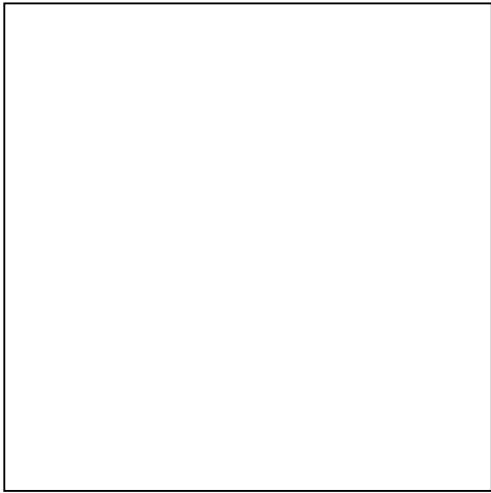

12. Symmetry pictures (Lesson 35)

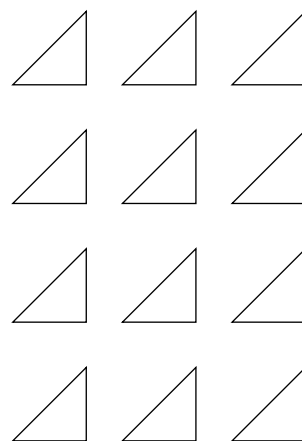
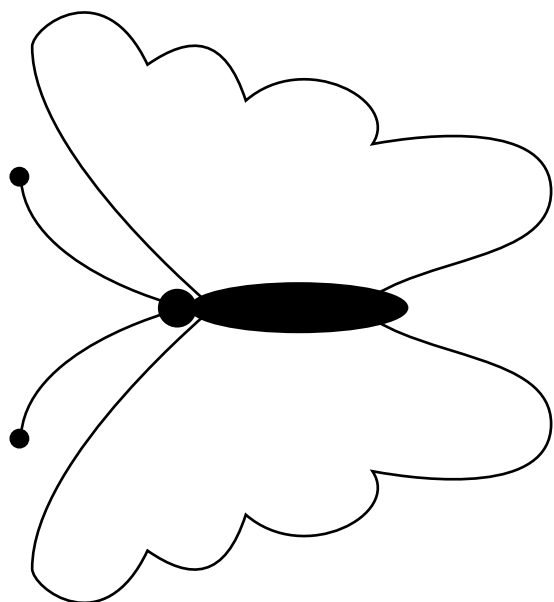
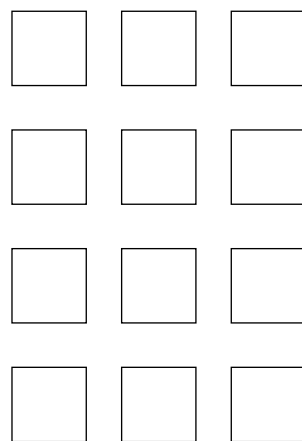
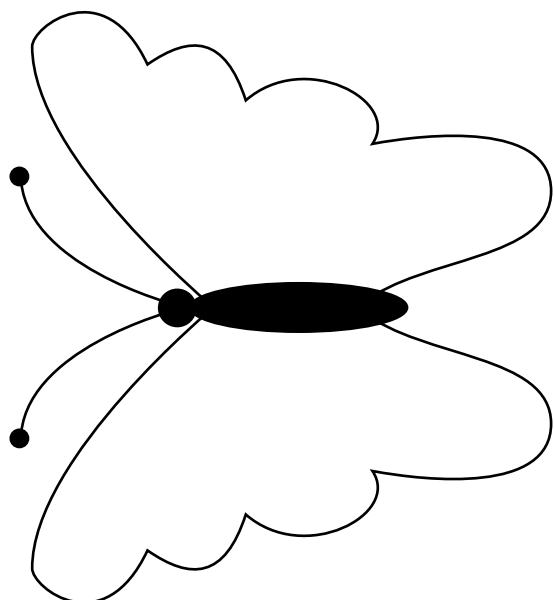
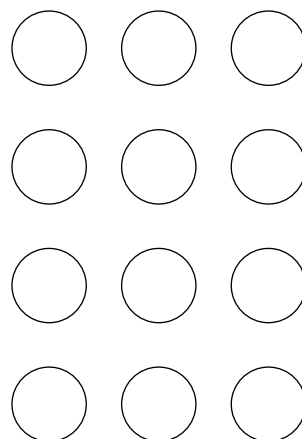
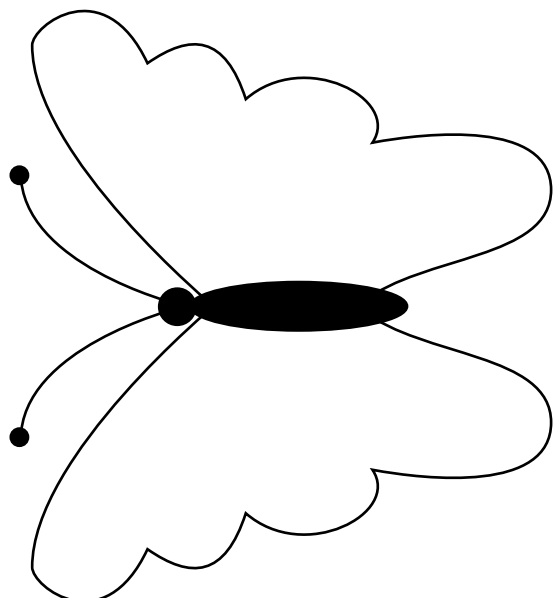

13. Days of the week (Lesson 38)

Monday

Tuesday

Wednesday

Thursday

Friday

Saturday

Sunday

14. Izinsuku zesonto (Isifundo 38)

uMsombuluko

uLwesibili

uLwesithathu

uLwesine

uLwesihlanu

uMgqibelo

iSonto

15. Months of the year (Lesson 38)

January

February

March

April

May

June

July

August

September

October

November

December

16. Izinyanga (Isifundo 38)

uMasingana

uNhlolanja

uNdasa

uMbasa

uNhlaba

uNhlanguvana

uNtulikazi

uNcwaba

uMandulo

uMfumfu

uLwezi

uZibandlela

2. Mental Mathematics Challenge Cards: Bilingual Version

Each term there will be a set of eight mental mathematics challenge cards. If you make them into cards and collect them over the course of the year, you will have a set of one card per teaching week for a year.

Use of the mental mathematics challenge cards

Once a week learners should do mental mathematics in written form, so that there is some record of your daily mental mathematics activities. You can use the **mental mathematics challenge cards** for this purpose.

Learners should not use concrete material to work out the answers in mental mathematics. If learners need to, let them use their fingers as a concrete aid during mental mathematics, but make a note of who they are and then spend time with them during remediation to help them with the basic number and operation skills. Mental mathematics skills improve hugely from Grade 1 to Grade 3. In Grade 1 learners might only manage five questions, especially when they have to write the answers, but by Grade 3 learners should manage ten questions with written answers easily.

Maths Challenge Card 1

Order from biggest to smallest

Ikhadi Lenselelo Yezibalo 1

Landelanisa usuke kokuncane kunakho konke uye kokukhulu kunakho konke

1. 18, 11, 15
2. 2, 20, 12
3. 17, 19, 14
4. 13, 16, 9
5. 15, 18, 20
6. 0, 11, 1
7. 20, 0, 10
8. 12, 11, 17
9. 9, 16, 19
10. 8, 15, 13

Maths Challenge Card 2

2 more than

Ikhadi Lenselelo Yezibalo 1

Okuningi ngoku-2 kunalokhu

1. 17
2. 11
3. 14
4. 9
5. 12
6. 18
7. 15
8. 10
9. 13
10. 16

Maths Challenge Card 3

2 less than

Ikhadi Lenselelo Yezibalo 3

Okuncane ngoku-2 kunalokhu

1. 17
2. 14
3. 20
4. 16
5. 15
6. 12
7. 18
8. 13
9. 11
10. 19

Maths Challenge Card 4

Double/Use doubles

Ikhadi Lenselelo Yezibalo 4

Phinda kabili

1. 7
2. 6
3. 9
4. 8
5. 5
6. 10
7. $8 + 8 + 1 =$
8. $6 + 6 + 1 =$
9. $9 + 9 + 1 =$
10. $7 + 7 + 1 =$

Maths Challenge Card 1: Answers

Order from biggest to smallest

Ikhadi Lenselelo Yezibalo 1: Izimpendulo

Landelanisa usuke kokuncane kunakho konke uye kokukhulu kunakho konke

1. 18, 15, 11
2. 20, 12, 2
3. 19, 17, 14
4. 16, 13, 9
5. 20, 18, 15
6. 11, 1, 0
7. 20, 10, 0
8. 17, 12, 11
9. 19, 16, 9
10. 15, 13, 8

Maths Challenge Card 2: Answers

2 more than

Ikhadi Lenselelo Yezibalo 2: Izimpendulo

Okuningi ngoku-2 kunalokhu

1. 19
2. 13
3. 16
4. 11
5. 14
6. 20
7. 17
8. 12
9. 15
10. 18

Maths Challenge Card 3: Answers

2 less than

Ikhadi Lenselelo Yezibalo 3: Izimpendulo

Okuncane ngoku-2 kunalokhu

1. 15
2. 12
3. 18
4. 14
5. 13
6. 10
7. 16
8. 11
9. 9
10. 17

Maths Challenge Card 4: Answers

Double/Use doubles

Ikhadi Lenselelo Yezibalo 4: Izimpendulo

Phinda kabili

1. 14
2. 12
3. 18
4. 16
5. 10
6. 20
7. 17
8. 13
9. 19
10. 15

Maths Challenge Card 5

Halve/Find half

Ikhadi Lenselelo Yezibalo 5

Thola uhhafu

1. 20
2. 14
3. 8
4. 12
5. 17
6. 18
7. 10
8. 6
9. 19
10. 16

Maths Challenge Card 6

Add

Ikhadi Lenselelo Yezibalo 6

Hlanganisa

1. $7 + \underline{\quad} = 10$
2. $10 + \underline{\quad} = 10$
3. $2 + \underline{\quad} = 10$
4. $9 + \underline{\quad} = 10$
5. $5 + \underline{\quad} = 9$
6. $6 + \underline{\quad} = 10$
7. $3 + \underline{\quad} = 9$
8. $5 + \underline{\quad} = 7$
9. $5 + \underline{\quad} = 10$
10. $0 + \underline{\quad} = 8$

Maths Challenge Card 7

Subtract

Ikhadi Lenselelo Yezibalo 7

Susa

1. $10 - 5 =$
2. $7 - 3 =$
3. $9 - 2 =$
4. $10 - 6 =$
5. $8 - 4 =$
6. $7 - 7 =$
7. $10 - 4 =$
8. $9 - 8 =$
9. $8 - 5 =$
10. $10 - 7 =$

Maths Challenge Card 8

Add and subtract 0–10

Ikhadi Lenselelo Yezibalo 8

Hlanganisa ususe 0–10

1. $2 + 8 =$
2. $9 - 5 =$
3. $6 + 4 =$
4. $10 - 5 =$
5. $3 + 7 =$
6. $7 - 4 =$
7. $6 + 0 =$
8. $9 - 3 =$
9. $5 + 2 =$
10. $10 - 4 =$

Maths Challenge Card 5: Answers

Halve/Find half

Ikhadi Lenselelo Yezibalo 5: Izimpendulo

Thola uhhafu

1. 10
2. 7
3. 4
4. 6
5. 8 and 1 left over / Ku-8 nensalela e-1
6. 9
7. 5
8. 3
9. 9 and 1 left over / Ku-9 nensalela e-1
10. 8

Maths Challenge Card 6: Answers

Add

Ikhadi Lenselelo Yezibalo 6: Izimpendulo

Hlanganisa

1. 3
2. 0
3. 8
4. 1
5. 4
6. 4
7. 6
8. 2
9. 5
10. 8

Maths Challenge Card 7: Answers

Subtract

Ikhadi Lenselelo Yezibalo 7: Izimpendulo

Susa

1. 15
2. 4
3. 7
4. 4
5. 4
6. 0
7. 6
8. 1
9. 3
10. 3

Maths Challenge Card 8: Answers

Add and subtract 0–10

Ikhadi Lenselelo Yezibalo 8: Izimpendulo

Hlanganisa ususe 0–10

1. 10
2. 4
3. 10
4. 5
5. 10
6. 3
7. 6
8. 6
9. 7
10. 6

3. Enrichment Activity Cards: English Version

Each term a set of new enrichment cards will be provided. You should retain this set, as they will not be reproduced each term.

Use of the enrichment activity cards

Optional as required.

These cards include activities that you can use for enrichment opportunities for learners who have completed the lesson activities ahead of the rest of the class. Learners should work on these cards independently or with their peers who have also completed the classwork. You may need to explain some of the activities to the learners who use them. You should remind them to ask you questions about any of the enrichment activities that they are doing, so that you can guide them as necessary.

You should photocopy the enrichment cards, paste them onto cardboard and laminate them (if possible), so that they can be used as a resource, not only this year but in the future as well.

Put the laminated cardboard cards into a box in a set place in your classroom, so that learners know where to find them. These cards are for all learners and do not have to be used in a particular order. Learners should keep a record of the cards that they have done, so that they continue to choose a new card each time they go to the box. Learners must be taught to replace the cards in numeric order in the box, so that everyone who looks for cards can easily find the one they want to use.

Enrichment Activity 4.1

Count the different shapes.

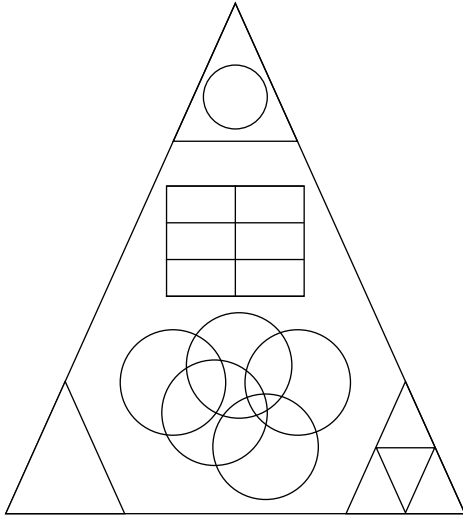

How many \triangle are there? _____

How many \square are there? _____

How many \bigcirc are there? _____

Enrichment Activity 4.2

Help Sarah to find her lost dog by filling in the rest of the counters.

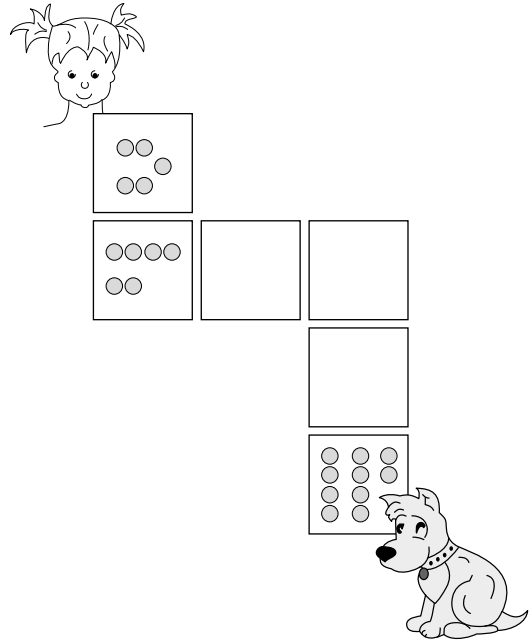

Enrichment Activity 4.3

Work out the problems and complete the crossword puzzle by filling in the number names.

Down

1. $10 + 6 =$

2. $6 + 5 =$

Across

1. $12 - 6 =$

3. $6 + 6 =$

4. $20 - 10 =$

5. $8 + 11 =$

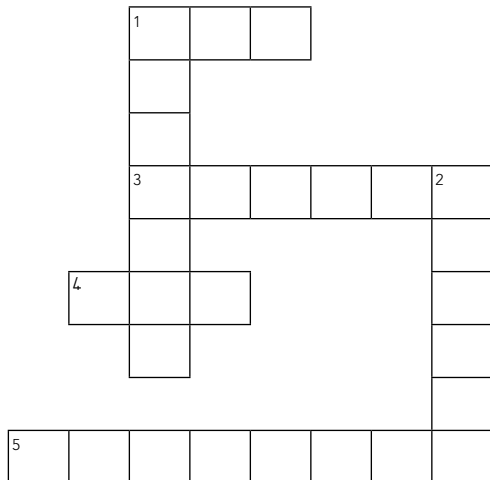

Enrichment Activity 4.4

Complete the following patterns.

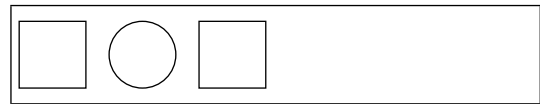
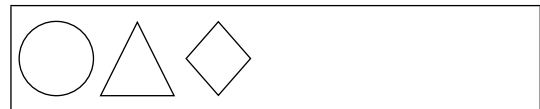

Enrichment Activity 4.1: Answers

Count the different shapes.

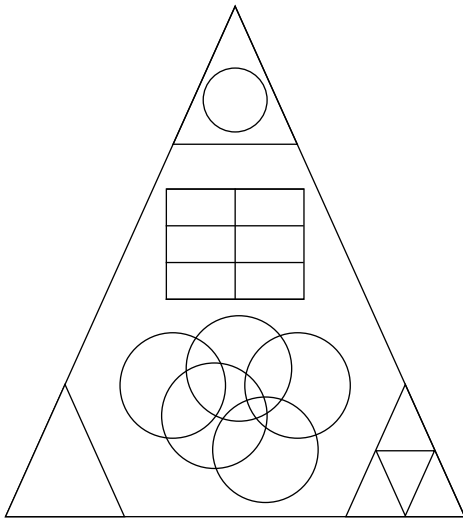

How many \triangle are there? (8)

How many \square are there? (14)

How many \circ are there? (6)

Enrichment Activity 4.2: Answers

Help Sarah to find her lost dog by filling in the rest of the counters.

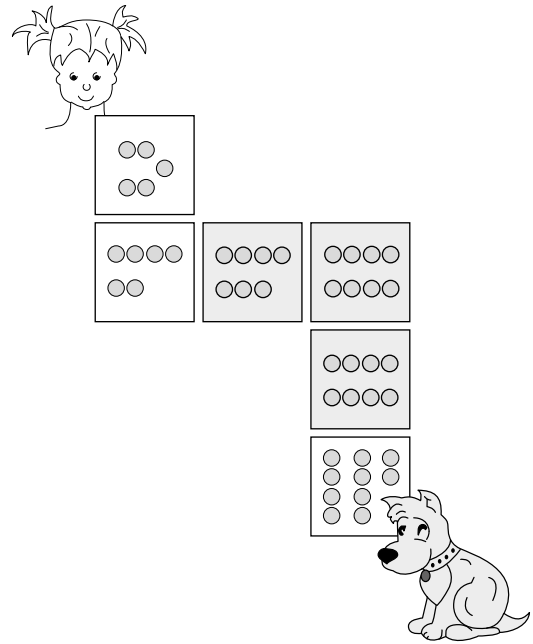

Enrichment Activity 4.3: Answers

Work out the problems and complete the crossword puzzle by filling in the number names.

Down

1. $10 + 6 =$

2. $6 + 5 =$

Across

1. $12 - 6 =$

3. $6 + 6 =$

4. $20 - 10 =$

5. $8 + 11 =$

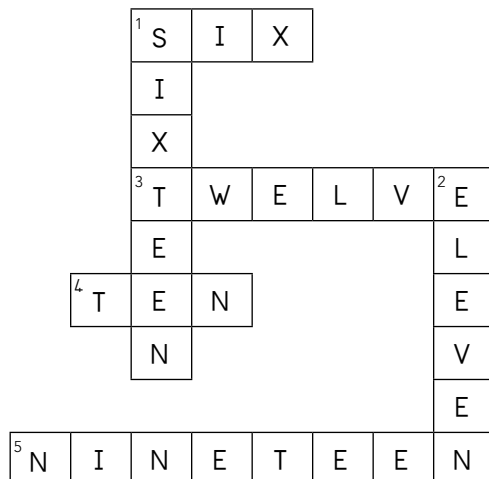

Enrichment Activity 4.4: Answers

Complete the following patterns.

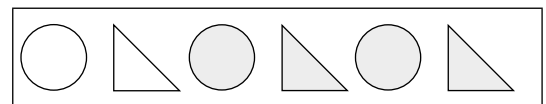
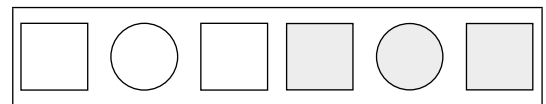
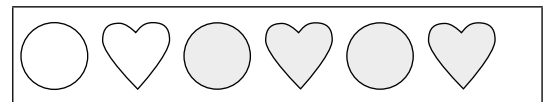
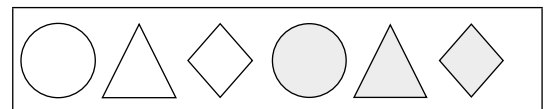

Enrichment Activity 4.5

Work out the pattern to complete the worm.

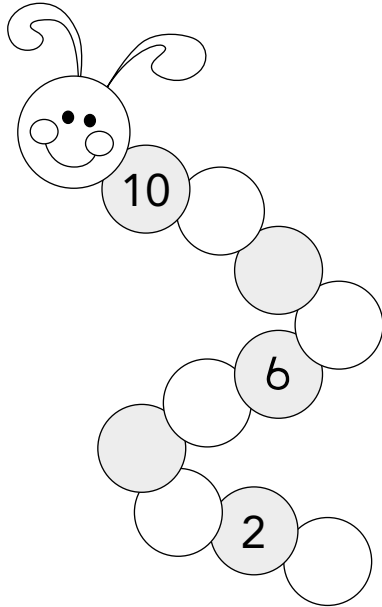

Enrichment Activity 4.6

What shape or shapes are coloured?

Choose the correct answer.

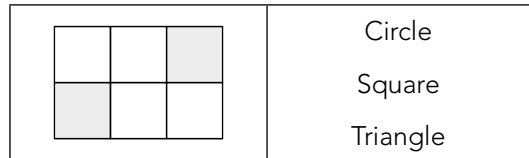
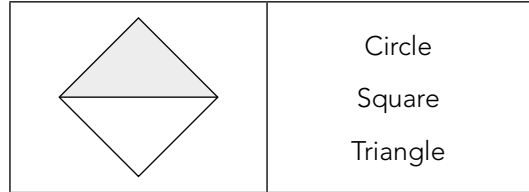
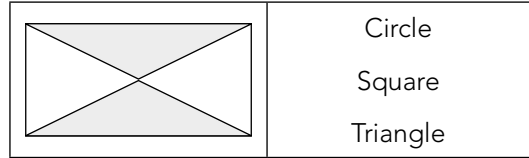

Enrichment Activity 4.7

Add up the money on each path and then circle the ice-cream that is the cheapest.

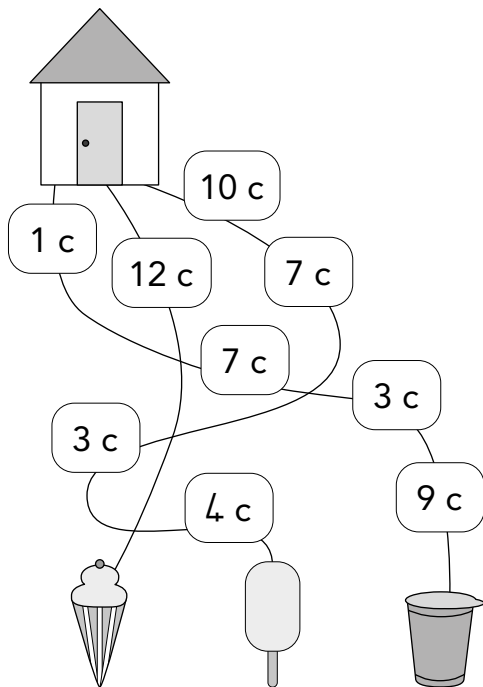

Enrichment Activity 4.8

Circle the line that is the longest. You may not use a ruler to measure the lines.

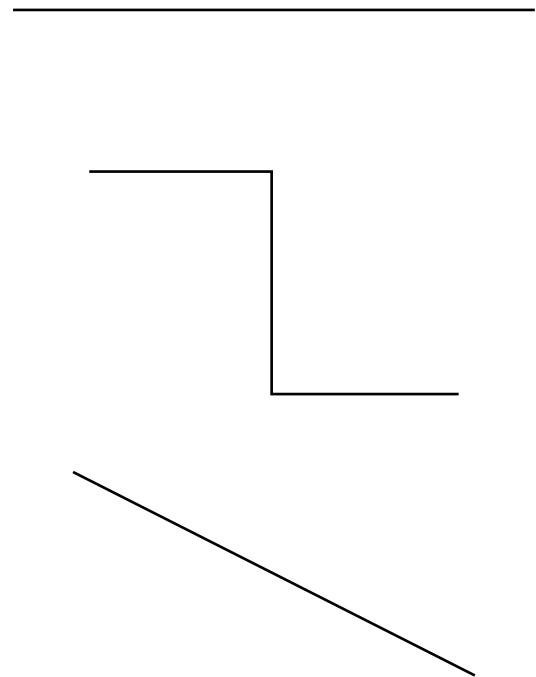

Enrichment Activity 4.5: Answers

Work out the pattern to complete the worm.

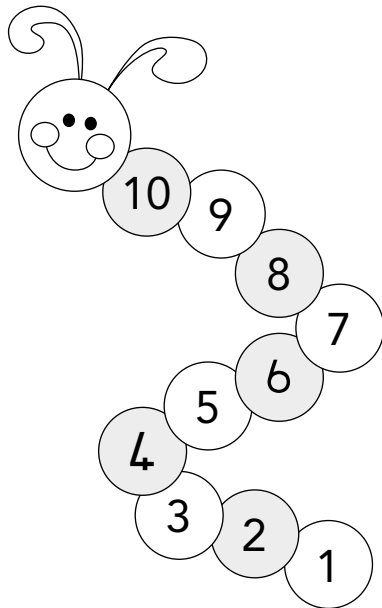

Enrichment Activity 4.6: Answers

What shape or shapes are coloured?

Choose the correct answer.

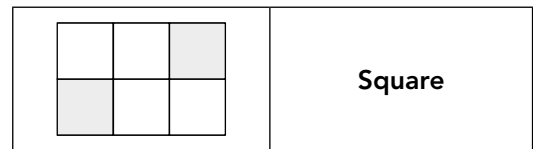
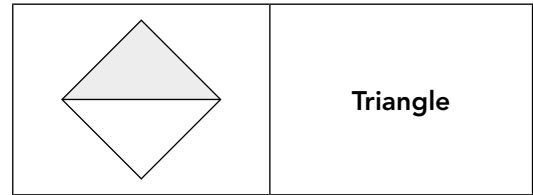
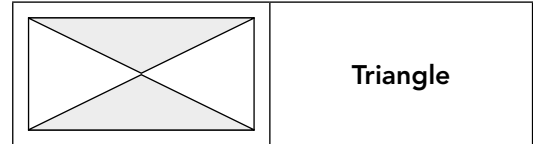

Enrichment Activity 4.7: Answers

Add up the money on each path and then circle the ice-cream that is the cheapest.

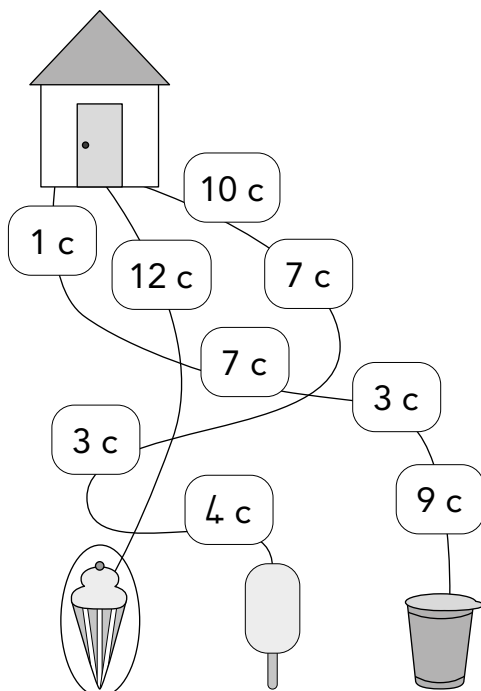

Enrichment Activity 4.8: Answers

Circle the line that is the longest. You may not use a ruler to measure the lines.

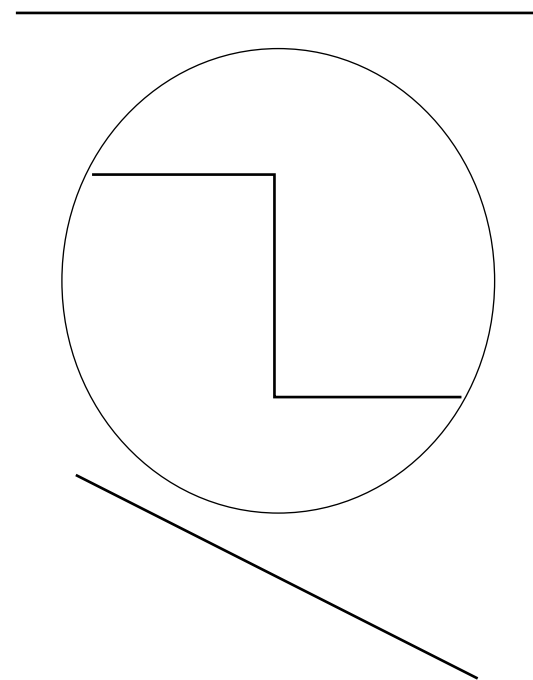

Enrichment Activity 4.9

Circle the longest line.

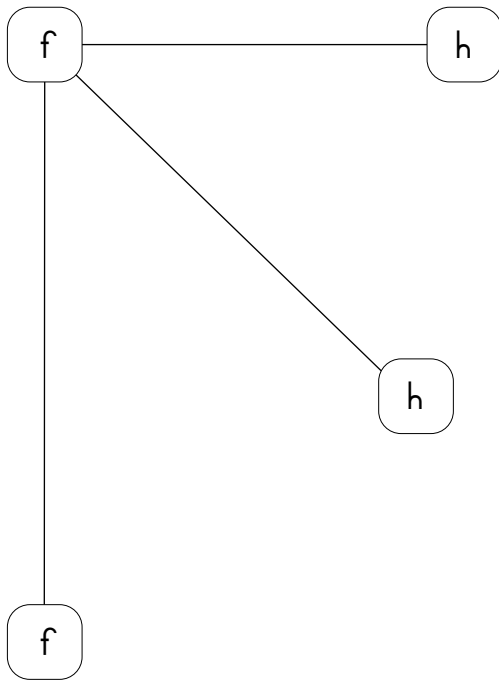

Enrichment Activity 4.10

Jane and Jake are playing marbles.
Add their scores to see who is winning.

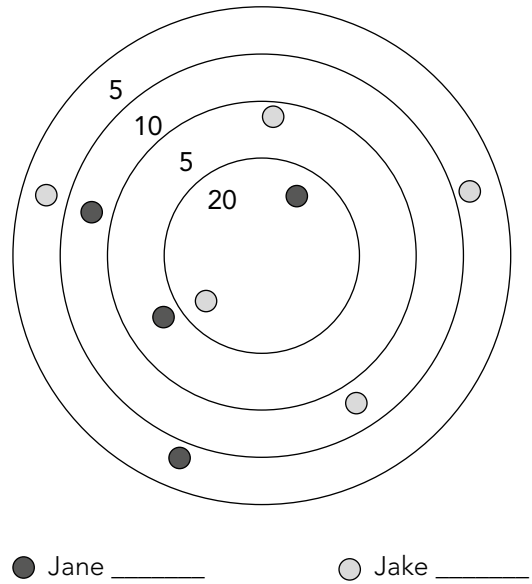

Enrichment Activity 4.11

Divide this square into 4 smaller squares.

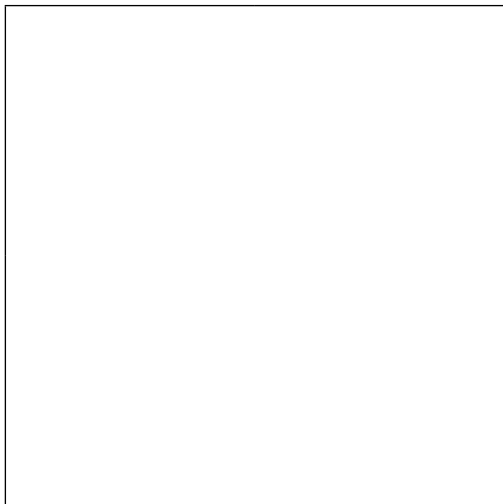

Enrichment Activity 4.12

Use the numbers to see how many sums you can make with 20 as the answer.

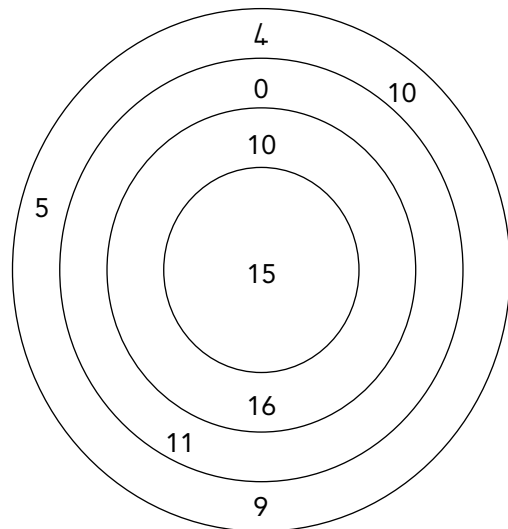

Enrichment Activity 4.9: Answers

Circle the longest line.

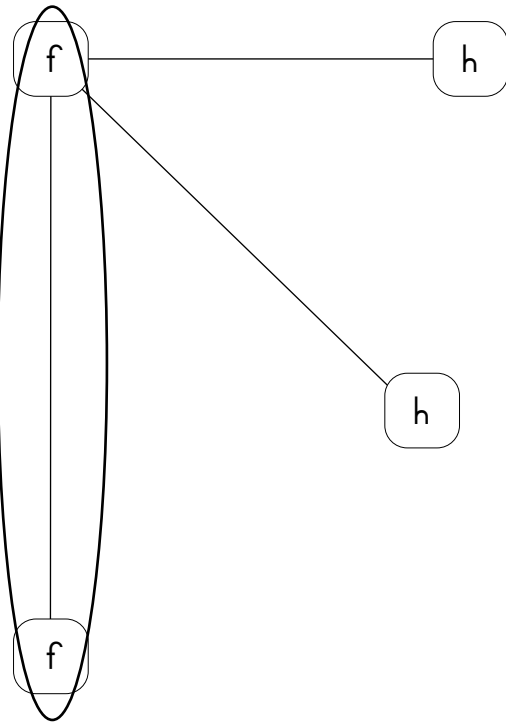

Enrichment Activity 4.10: Answers

Jane and Jake are playing marbles.
Add their scores to see who is winning.

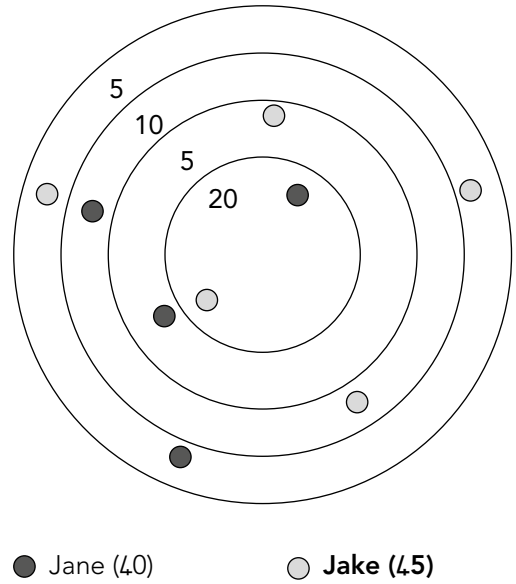

Enrichment Activity 4.11: Answers

Divide this square into 4 smaller squares.

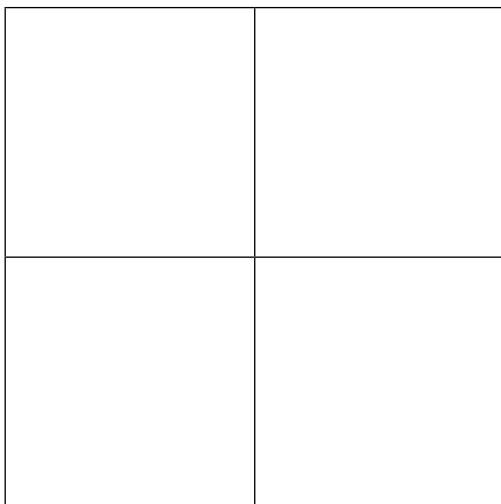

Enrichment Activity 4.12: Answers

Use the numbers to see how many sums you can make with 20 as the answer.

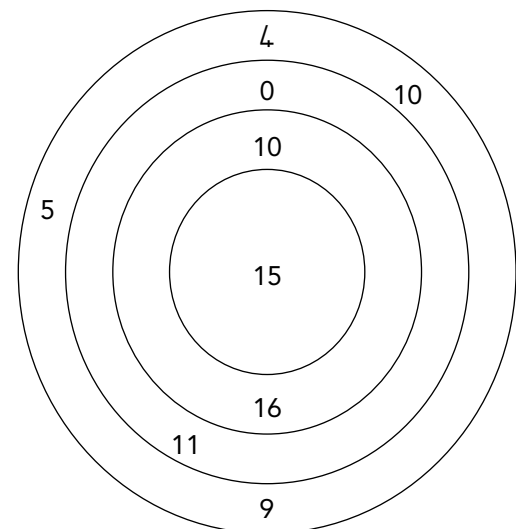

You can make 4 sums:
 $10 + 10$, $15 + 5$, $11 + 9$, $16 + 4$.

Enrichment Activity 4.13

Match the problems in Block A with the answers in Block B.

Block A	Block B
$5 + 14 =$	18
$20 - 2 =$	16
$16 - 3 =$	19
$12 + 6 =$	10
$16 + 0 =$	18
$10 + 7 =$	18
$14 - 4 =$	6
$17 + 1 =$	17
$15 - 9 =$	13

Enrichment Activity 4.14

Try to work out the sums in these blocks.

+	8	1	10
2			
4			
6			
8			
10			

Enrichment Activity 4.15

How many \triangle do you see?

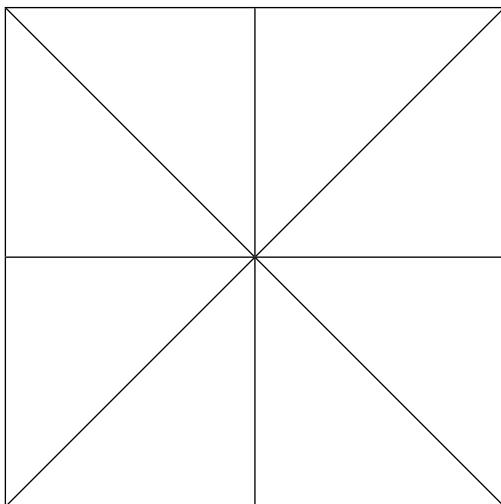

12 Triangles

16 Triangles

13 Triangles

14 Triangles

Enrichment Activity 4.16

Match the numbers with the number names.

Numbers	Number names
8	Two
10	Seven
9	Eight
7	Nine
2	Ten
4	Three
3	Four

Enrichment Activity 4.13: Answers

Match the problems in Block A with the answers in Block B.

Block A	Block B
$5 + 14 =$	18
$20 - 2 =$	16
$16 - 3 =$	19
$12 + 6 =$	10
$16 + 0 =$	18
$10 + 7 =$	18
$14 - 4 =$	6
$17 + 1 =$	17
$15 - 9 =$	13

Enrichment Activity 4.14: Answers

Try to work out the sums in these blocks.

+	8	1	10
2	10	3	12
4	12	5	14
6	14	7	16
8	16	9	18
10	18	11	20

Enrichment Activity 4.15: Answers

How many \triangle do you see?

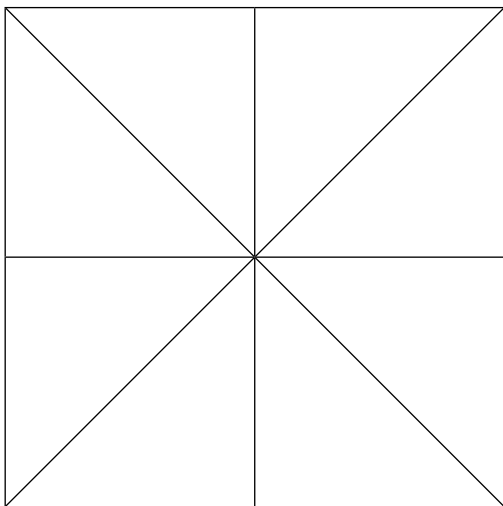

16 Triangles

Enrichment Activity 4.16: Answers

Match the numbers with the number names.

Numbers	Number names
8	Eight
10	Ten
9	Nine
7	Seven
2	Two
4	Four
3	Three

Enrichment Activity 4.17

Complete the table by working out the sums.

+	5	4	2
1			
2			
3			
4			
5			
6			
7			
8			
9			
10			

Enrichment Activity 4.18

Complete the pattern.

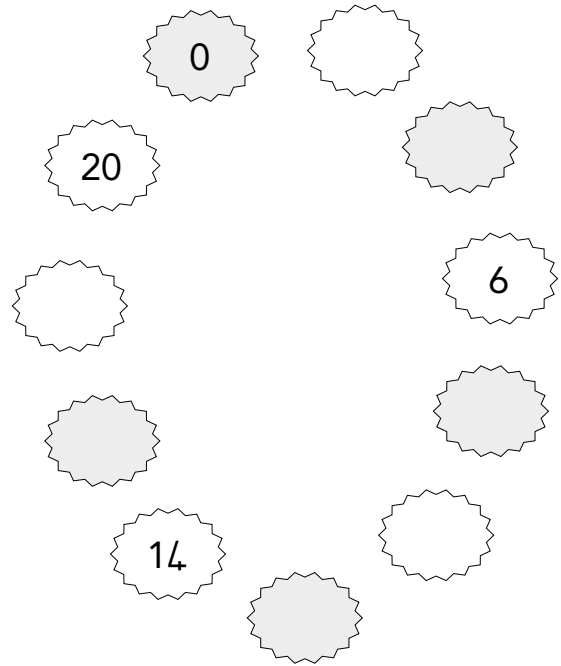

Enrichment Activity 4.19

Add the dots on the dominoes and fill in the answers.

How much will it be?

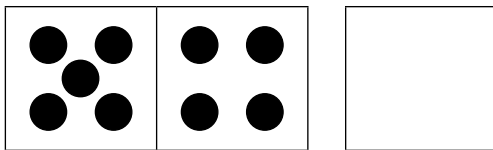

How much will it be?

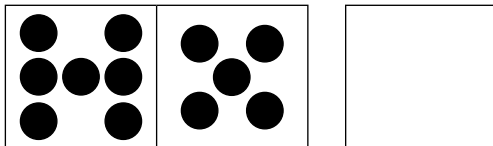

How much will it be?

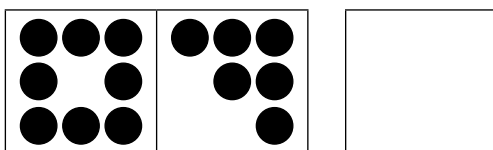

Enrichment Activity 4.20

Add the middle number to other numbers.

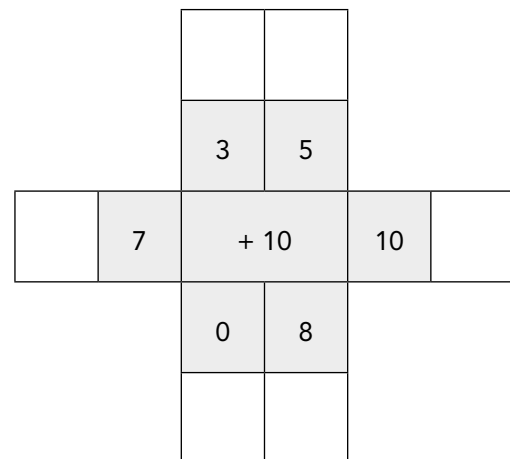

Enrichment Activity 4.17: Answers

Complete the table by working out the sums.

+	5	4	2
1	6	5	3
2	7	6	4
3	8	7	5
4	9	8	6
5	10	9	7
6	11	10	8
7	12	11	9
8	13	12	10
9	14	13	11
10	15	14	12

Enrichment Activity 4.18: Answers

Complete the pattern.

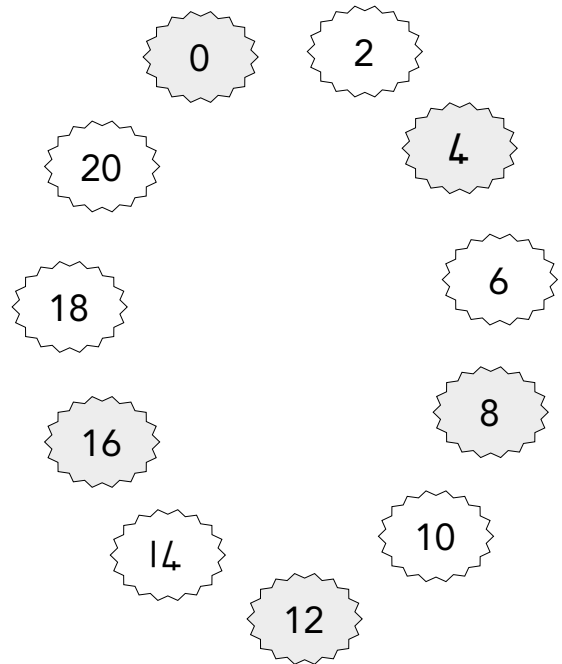

Enrichment Activity 4.19: Answers

Add the dots on the dominoes and fill in the answers.

How much will it be?

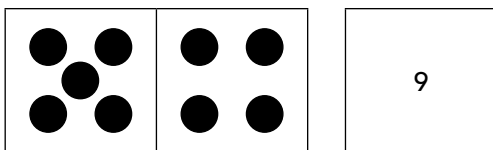

How much will it be?

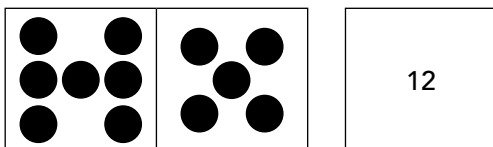

How much will it be?

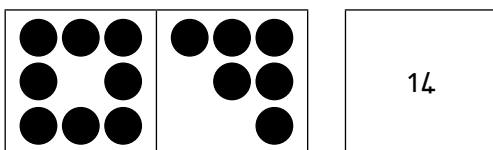

Enrichment Activity 4.20: Answers

Add the middle number to other numbers.

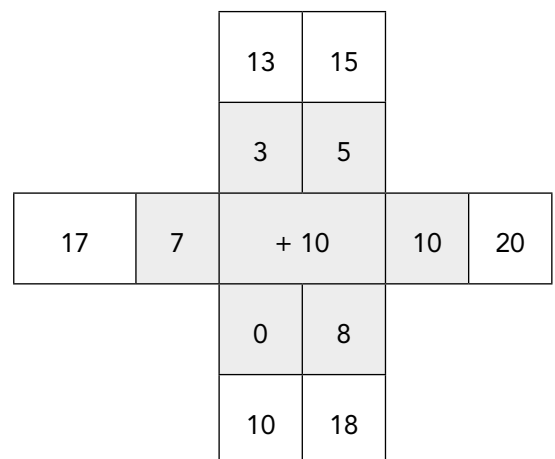

Enrichment Activity 4.21

Calculate the following and draw a line to the answer.

$14 + 1 =$

23

$3 + 20 =$

15

$17 - 3 =$

12

$19 - 7 =$

14

Enrichment Activity 4.22

Add the numbers to find the number in the middle.

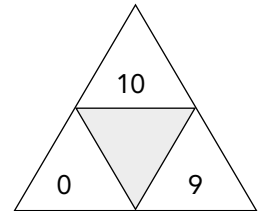
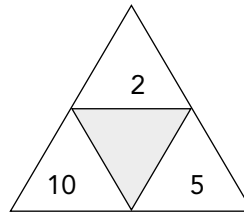
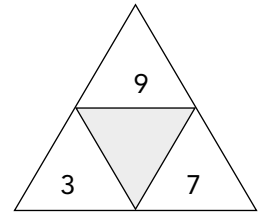
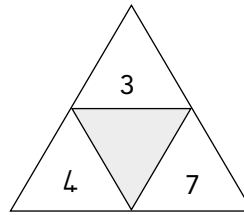

Enrichment Activity 4.23

The number in each hexagon is made up by adding the numbers in the two hexagons below it. Calculate the missing numbers.

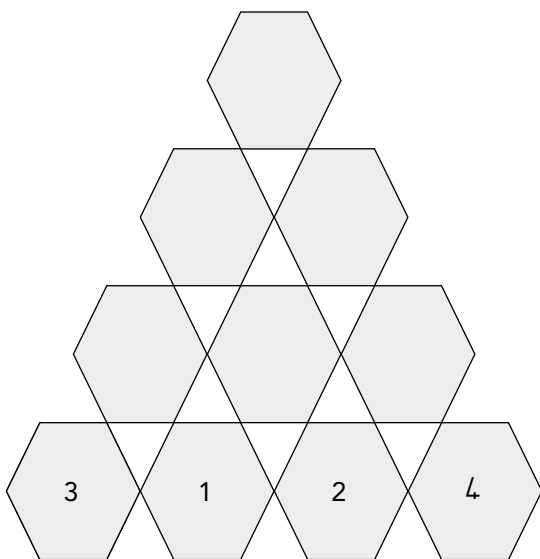

Enrichment Activity 4.24

Calculate each row of the puzzle. Fill in the answers. Calculate each column of the puzzle.

4	+	2	=	
+		+		+
3	+	7	=	
=		=		=
	+		=	

Enrichment Activity 4.21: Answers

Calculate the following and draw a line to the answer.

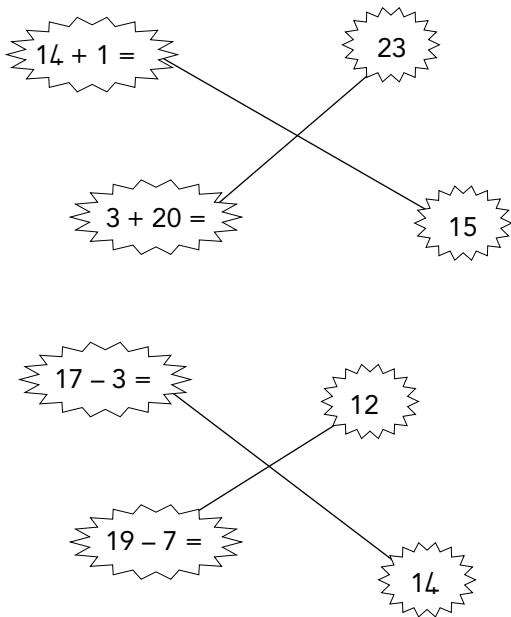

Enrichment Activity 4.22: Answers

Add the numbers to find the number in the middle.

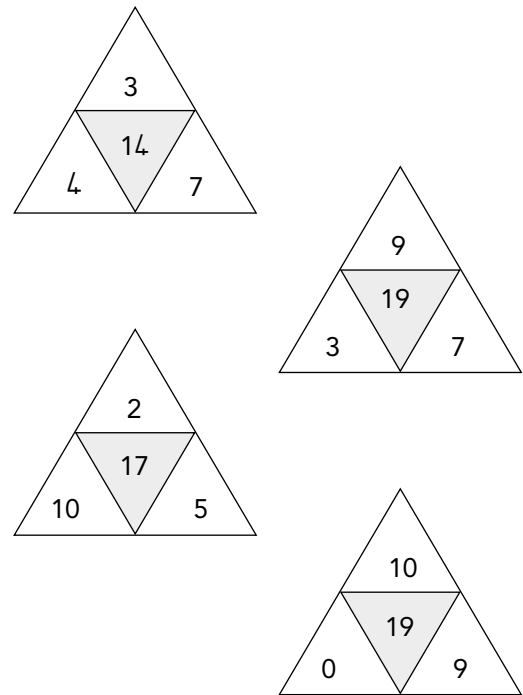

Enrichment Activity 4.23: Answers

The number in each hexagon is made up by adding the numbers in the two hexagons below it. Calculate the missing numbers.

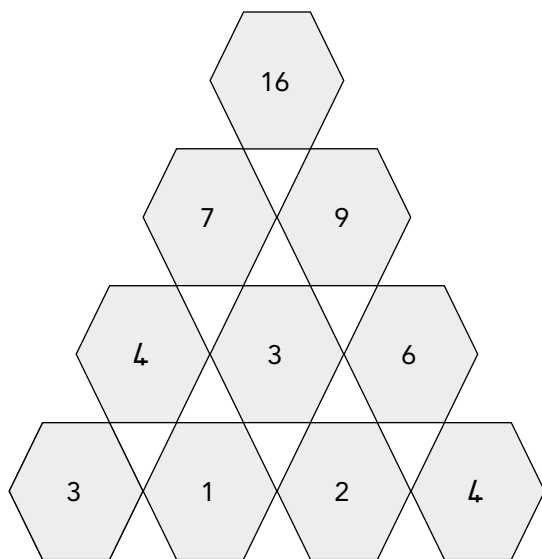

Enrichment Activity 4.24: Answers

Calculate each row of the puzzle. Fill in the answers. Calculate each column of the puzzle.

4	+	2	=	6
+		+		+
3	+	7	=	10
=		=		=
7	+	9	=	16

Enrichment Activity 4.25

How many ovals do you see?

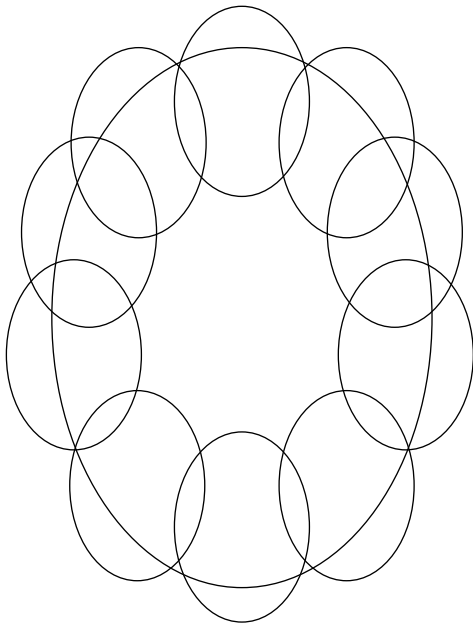

11 24 14

Enrichment Activity 4.26

How many  do you see?

How many  do you see?

How many  do you see?

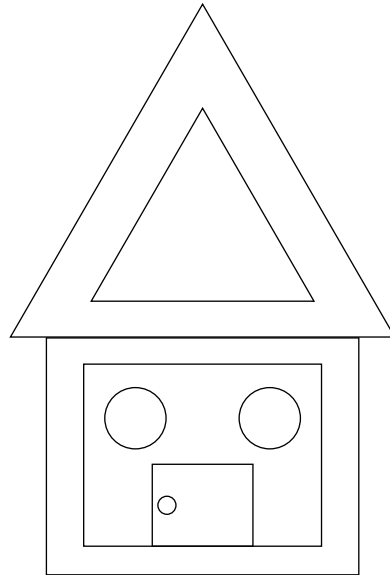

Enrichment Activity 4.27

Name the different shapes.

These words will help you:

triangle, circle, square.

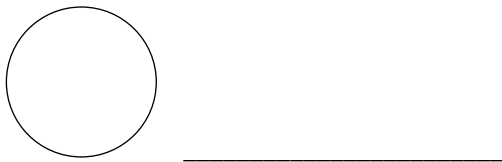

Enrichment Activity 4.28

Use these shapes to draw a picture.

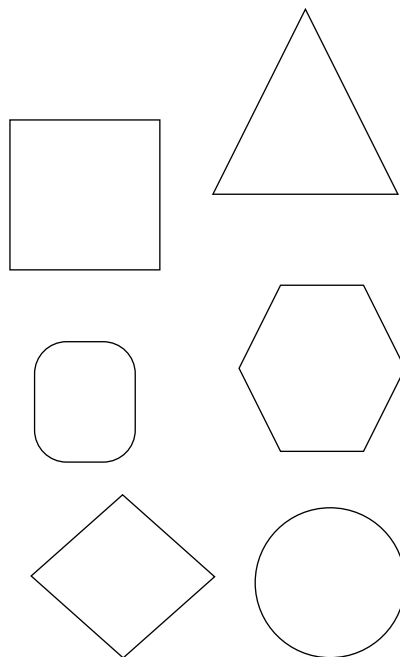

Enrichment Activity 4.25: Answers

How many ovals do you see?

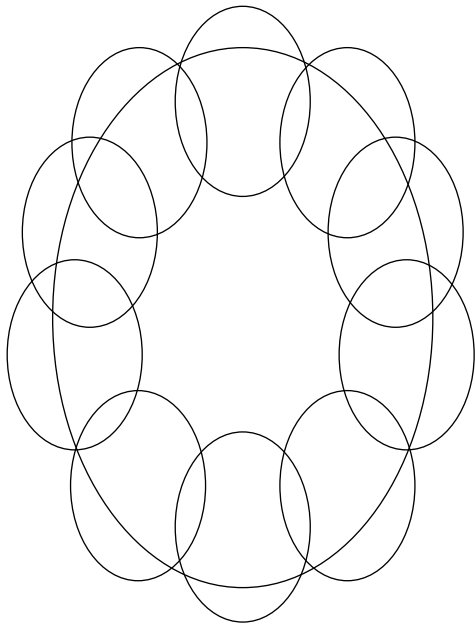

11 24 14

Enrichment Activity 4.26: Answers

How many  do you see? (3)

How many  do you see? (3)

How many  do you see? (2)

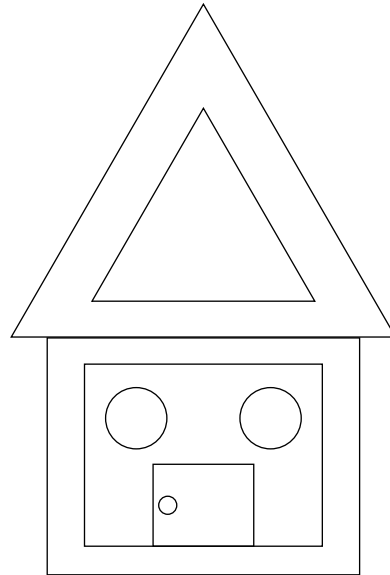

Enrichment Activity 4.27: Answers

Name the different shapes.

These words will help you:

triangle, circle, square.

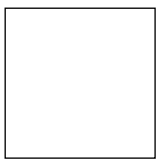

square

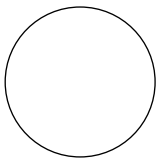

circle

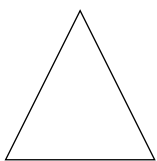

triangle

Enrichment Activity 4.28: Answers

Use these shapes to draw a picture.

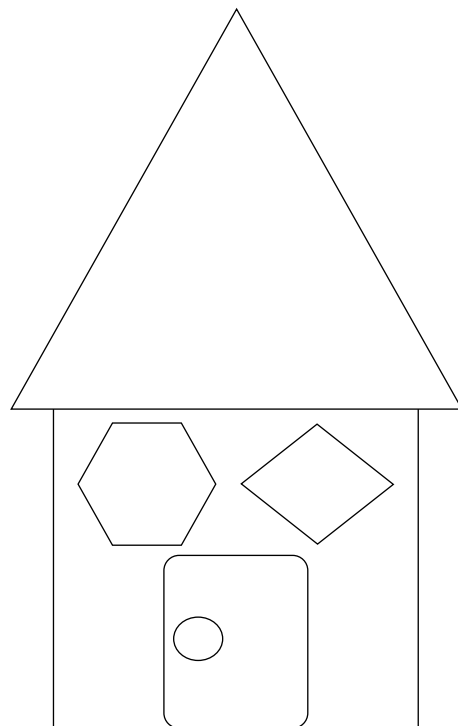

Enrichment Activity 4.29

Add each row of numbers to get an answer.

A 5x5 grid of numbers with shaded cells. The numbers are: Row 1: [] [] [] [] []; Row 2: [=] [] [=] [] [] []; Row 3: [3] [] [] [] [5]; Row 4: [] [7] [] [2] []; Row 5: [] [] [9] [] []; Row 6: [] [8] [] [1] []; Row 7: [] [0] [] [] [7]; Row 8: [=] [] [=] [] [] []; Row 9: [] [] [] [] []

Enrichment Activity 4.30

Write the number names for each of the following numbers.

8	
2	
3	
7	
9	
10	
5	
4	
1	
6	

Enrichment Activity 4.31

Add 10 and draw your answer on the right hand side.

A box containing 5 black dots and an empty box for drawing the answer.

A box containing 7 black dots and an empty box for drawing the answer.

A box containing 6 black dots and an empty box for drawing the answer.

Enrichment Activity 4.32

Which number is bigger?
Circle the bigger number.

- 10 or 14
12 or 9
15 or 5
16 or 20
0 or 13
17 or 7
20 or 19
5 or 11
10 or 11

Enrichment Activity 4.29: Answers

Add each row of numbers to get an answer.

19						16
=						=
	3				5	
		7		2		
			9			
		8		1		
	0				7	
=						=
17						17

Enrichment Activity 4.30: Answers

Write the number names for each of the following numbers.

8	eight
2	two
3	three
7	seven
9	nine
10	ten
5	five
4	four
1	one
6	six

Enrichment Activity 4.31: Answers

Add 10 and draw your answer on the right hand side.

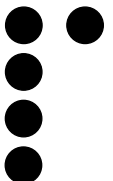
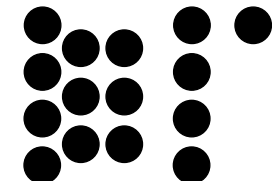
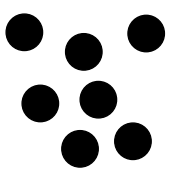
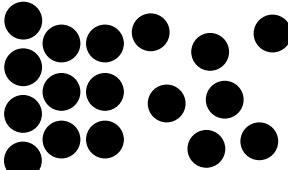
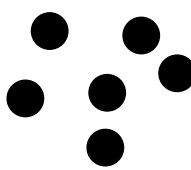
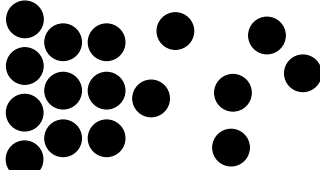
Enrichment Activity 4.32: Answers

Which number is bigger?
Circle the bigger number.

10	or	(14)	
(12)	or	9	
(15)	or	5	
16	or	(20)	
0	or	(13)	
(17)	or	7	
(20)	or	19	
5	or	(11)	
10	or	(11)	

4. Enrichment Activity Cards: isiZulu Version

Each term a set of new enrichment cards will be provided. You should retain this set, as they will not be reproduced each term.

Use of the enrichment activity cards

Optional as required.

These cards include activities that you can use for enrichment opportunities for learners who have completed the lesson activities ahead of the rest of the class. Learners should work on these cards independently or with their peers who have also completed the classwork. You may need to explain some of the activities to the learners who use them. You should remind them to ask you questions about any of the enrichment activities that they are doing, so that you can guide them as necessary.

You should photocopy the enrichment cards, paste them onto cardboard and laminate them (if possible), so that they can be used as a resource, not only this year but in the future as well.

Put the laminated cardboard cards into a box in a set place in your classroom, so that learners know where to find them. These cards are for all learners and do not have to be used in a particular order. Learners should keep a record of the cards that they have done, so that they continue to choose a new card each time they go to the box. Learners must be taught to replace the cards in numeric order in the box, so that everyone who looks for cards can easily find the one they want to use.

Umsebenzi Wokubakhulisa 4.1

Bala izimo ezahlukehlukene.

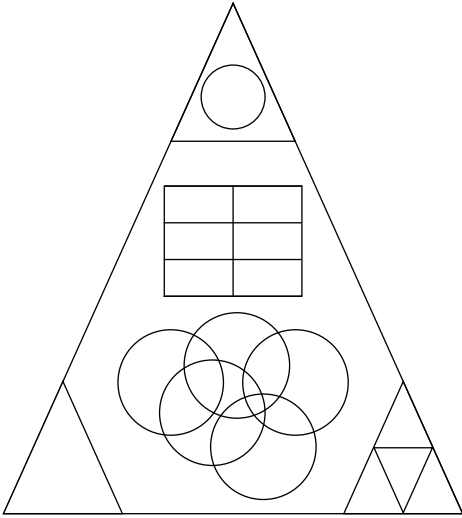

Kungaki \triangle lokhu? _____

Kungaki \square lokhu? _____

Kungaki \circ lokhu? _____

Umsebenzi Wokubakhulisa 4.2

Siza uSara atholeinja yakhe elahlekile ngokugcwalisa zonke izibali.

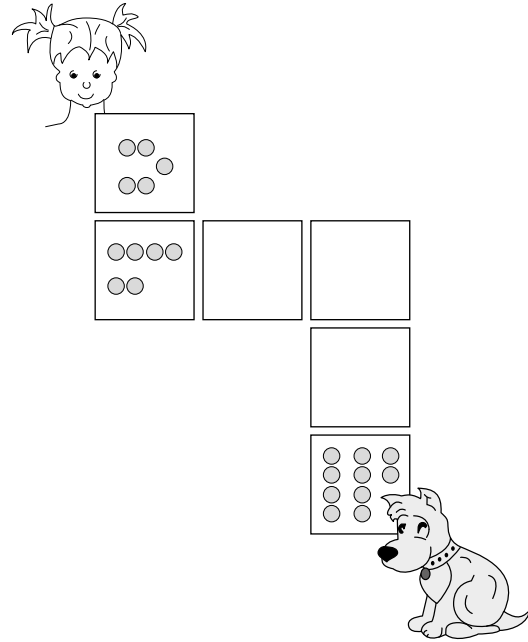

Umsebenzi Wokubakhulisa 4.3

Xazulula izinkinga futhi ugcalise isiphicamagama ngokufaka amagama enombolo.

Phansi

1. $10 + 6 =$

2. $6 + 5 =$

Ukuvundla

1. $12 - 6 =$

3. $6 + 6 =$

4. $20 - 10 =$

5. $8 + 11 =$

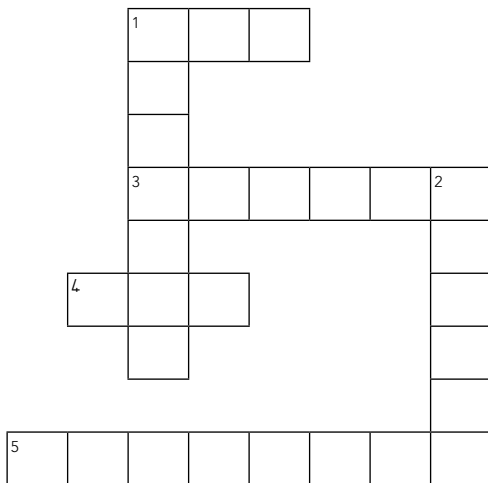

Umsebenzi Wokubakhulisa 4.4

Qedela la maphethini alandelayo.

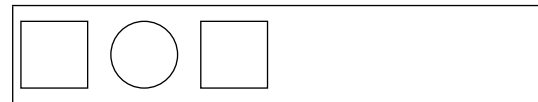
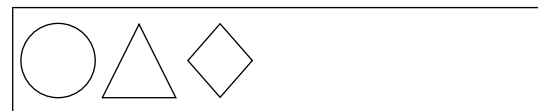

Umsebenzi Wokubakhulisa 4.1: Izimpendulo

Bala izimo ezahlukahlukene.

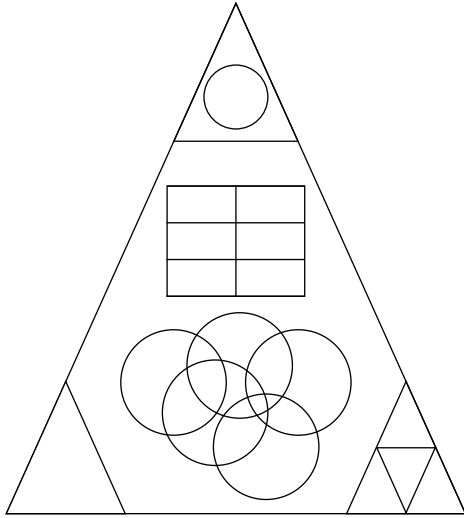

Kungaki \triangle lokhu? (8)

Kungaki lokhu? (14)

Kungaki \bigcirc lokhu? (6)

Umsebenzi Wokubakhulisa 4.2: Izimpendulo

Siza uSara athole inja yakhe elahlekile ngokugcwalisa zonke izibali.

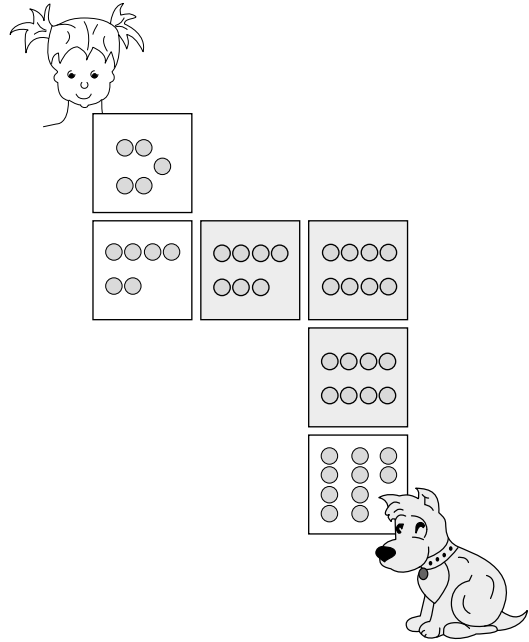

Umsebenzi Wokubakhulisa 4.3: Izimpendulo

Xazulula izinkinga futhi ugcwalise isiphicamagama ngokufaka amagama enombolo.

Phansi

1. $10 + 6 =$

2. $6 + 5 =$

Ukuvundla

1. $12 - 6 =$

3. $6 + 6 =$

4. $20 - 10 =$

5. $8 + 11 =$

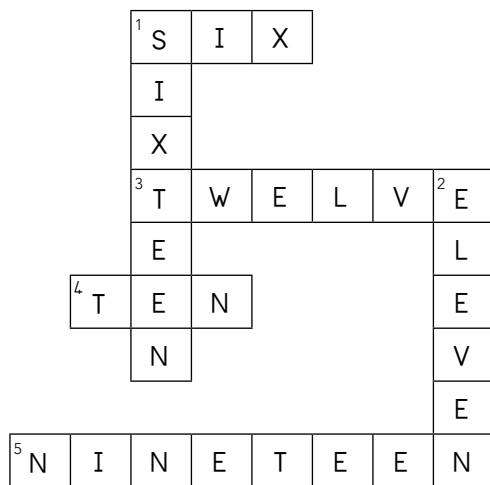

Umsebenzi Wokubakhulisa 4.4: Izimpendulo

Qedela la maphethini alandelayo.

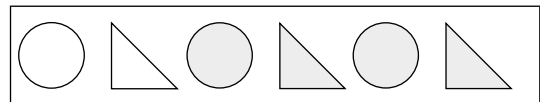
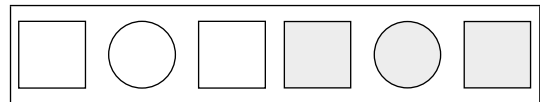
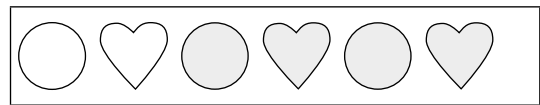
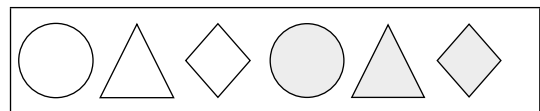

Umsebenzi Wokubakhulisa 4.5

Yenza iphethini ukuze uqedele isibungu.

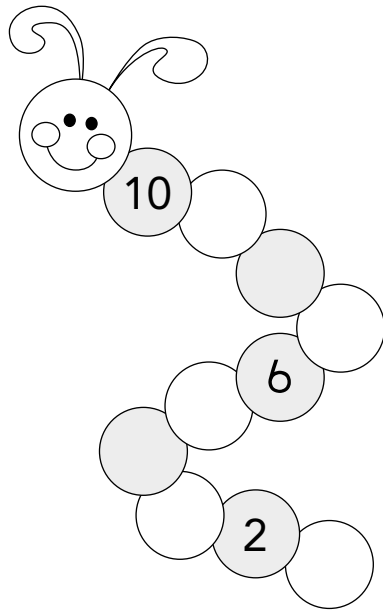

Umsebenzi Wokubakhulisa 4.6

Yisiphi isimo noma izimo ezifakwe imibala?

Khetha impendulo efanele.

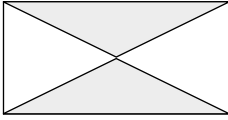
	Isiyingi Isikwele Unxantathu
--	------------------------------------

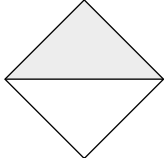
	Isiyingi Isikwele Unxantathu
--	------------------------------------

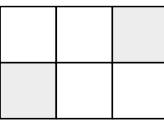
	Isiyingi Isikwele Unxantathu
--	------------------------------------

Umsebenzi Wokubakhulisa 4.7

Hlanganisa imali endleleni ngayinye bese ukokelezela i-ayisikhilimu ebiza kancane kakhulu.

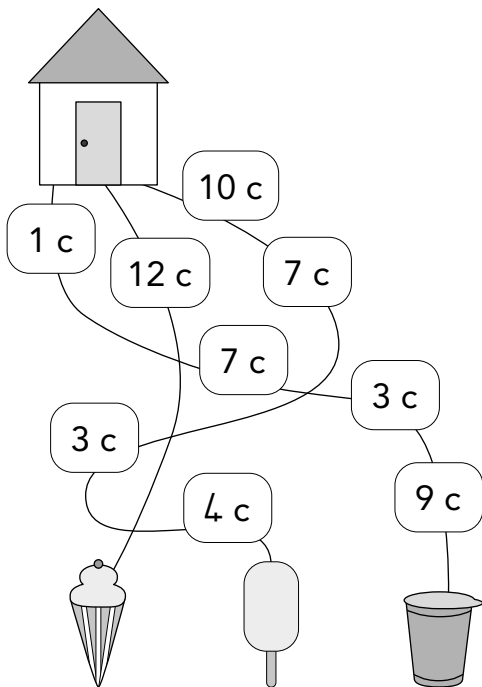

Umsebenzi Wokubakhulisa 4.8

Kokelezela umugqa omude kunayo yonke. Ungalisebenzisi irula ukukala imigqa.

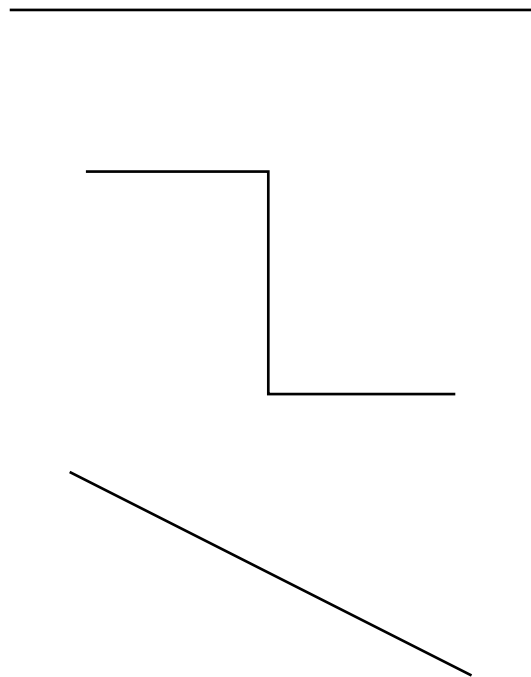

Umsebenzi Wokubakhulisa 4.5: Izimpendulo

Yenza iphethini ukuze uqedelele isibungu.

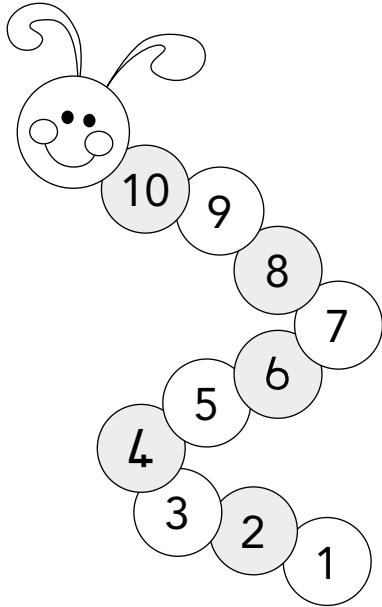

Umsebenzi Wokubakhulisa 4.6: Izimpendulo

Yisiphi isimo noma izimo ezifakwe imibala?

Khetha impendulo efanele.

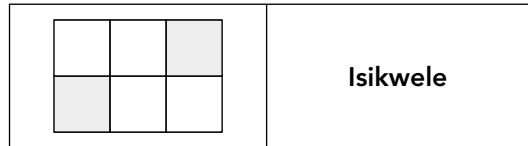
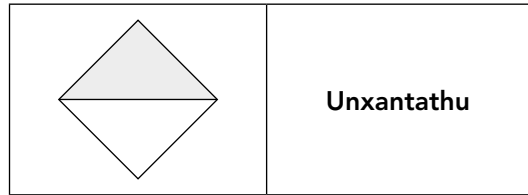
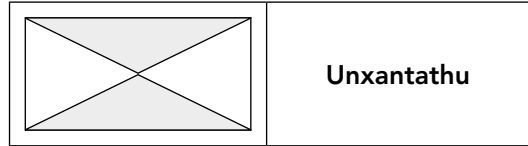

Umsebenzi Wokubakhulisa 4.7: Izimpendulo

Hlanganisa imali endleleni ngayinye bese ukokelezela i-ayisikhilimu ebiza kancane kakhulu.

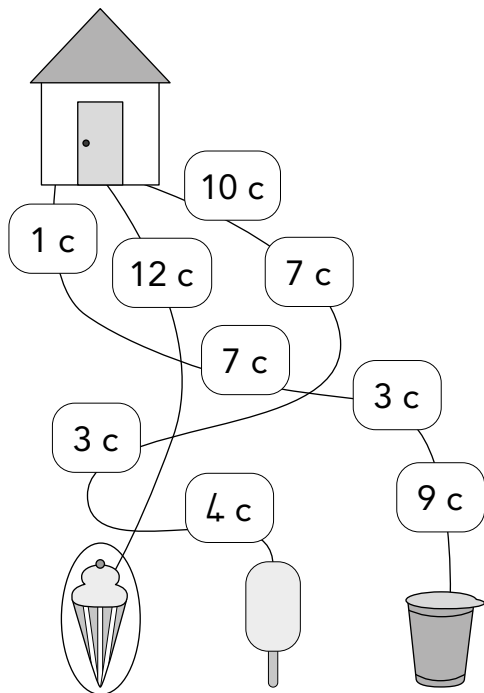

Umsebenzi Wokubakhulisa 4.8: Izimpendulo

Kokelezela umugqa omude kunayo yonke.

Ungalibenzisi irula ukukala imigqa.

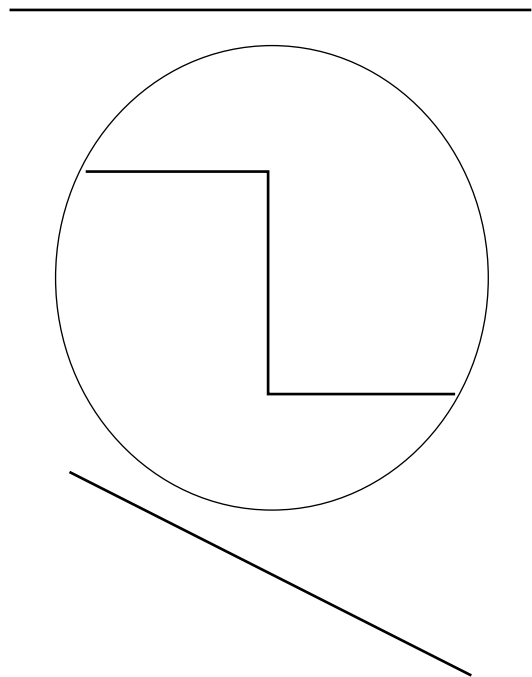

Umsebenzi Wokubakhulisa 4.9

Kokelezela umugqa omude kunayo yonke.

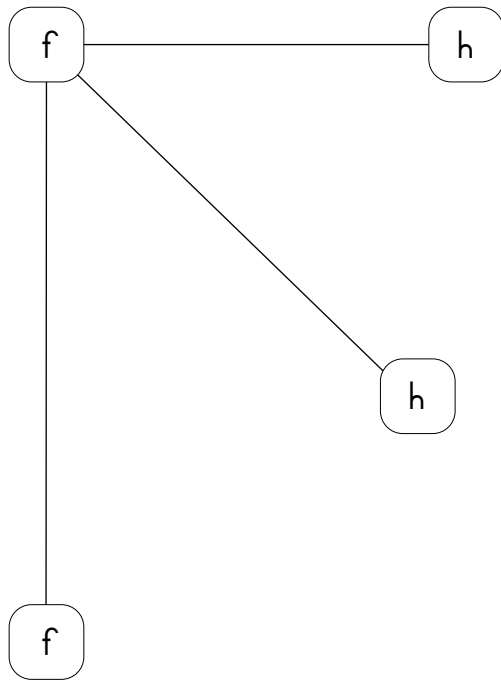

Umsebenzi Wokubakhulisa 4.10

uJane noJake badlala izimabule. Hlanganisa amaphuzu abawazuzile ukuze uthole ukuthi ubani onqobayo.

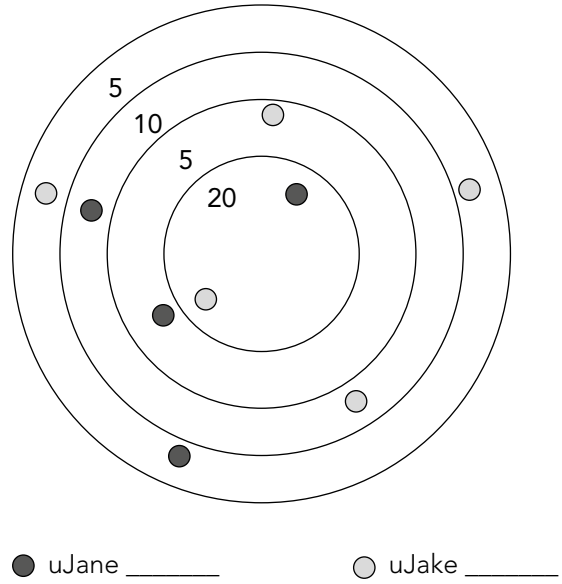

Umsebenzi Wokubakhulisa 4.11

Hlukanisa lesi sikwele sibe yizikwele ezincane ezi-4.

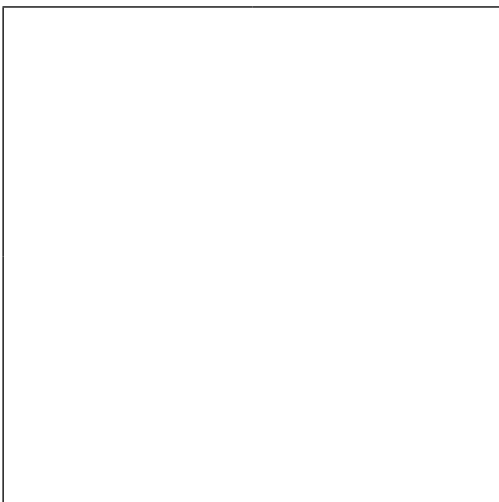

Umsebenzi Wokubakhulisa 4.12

Sebenzisa izinombolo ukubona ukuthi zingaki izibalo ongazakha zibe nempendulo engama-20.

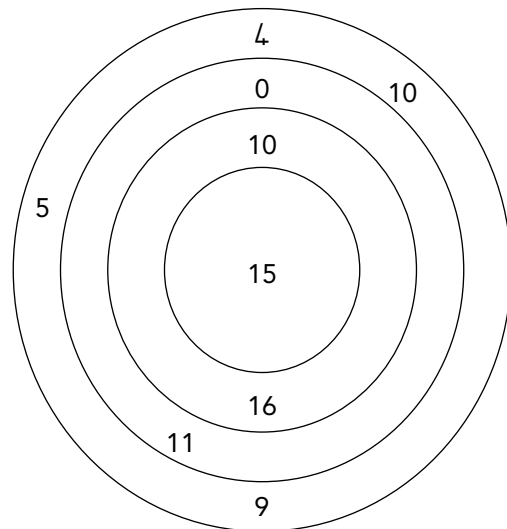

Umsebenzi Wokubakhulisa 4.9: Izimpendulo

Kokelezela umugqa omude kunayo yonke.

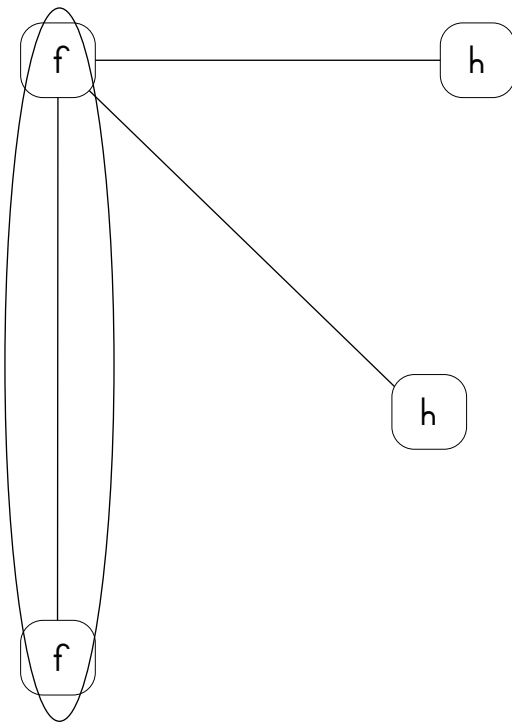

Umsebenzi Wokubakhulisa 4.10: Izimpendulo

uJane noJake badlala izimabule. Hlanganisa amaphuzu abawazuzile ukuze uthole ukuthi ubani onqobayo.

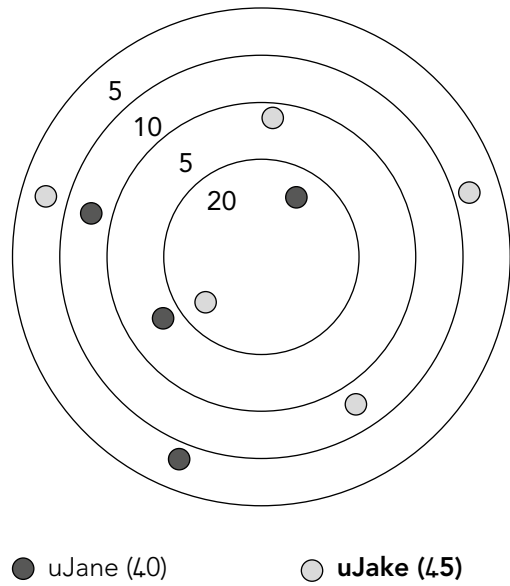

Umsebenzi Wokubakhulisa 4.11: Izimpendulo

Hlukanisa lesi sikwele sibe yizikwele ezincane ezi-4.

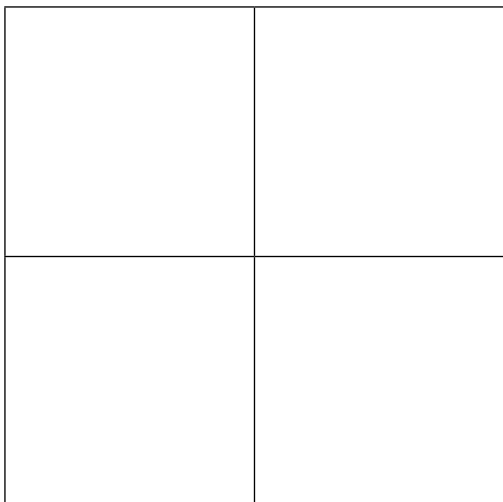

Umsebenzi Wokubakhulisa 4.12: Izimpendulo

Sebenzisa izinombolo ukubona ukuthi zingaki izibalo ongazakha zibe nempendulo engama-20.

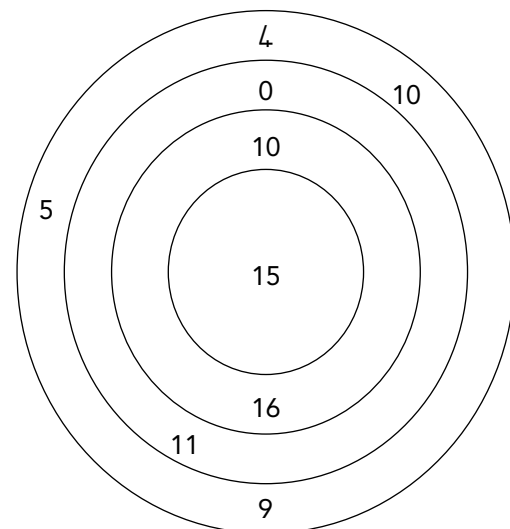

Ungenza izibalo ezi-4:

$10 + 10$, $15 + 5$, $11 + 9$, $16 + 4$.

Umsebenzi Wokubakhulisa 4.13

Qondanisa izinkinga ezisebhulokhini A nezimpendulo ezisebhulokhini B.

A	B
$5 + 14 =$	18
$20 - 2 =$	16
$16 - 3 =$	19
$12 + 6 =$	10
$16 + 0 =$	18
$10 + 7 =$	18
$14 - 4 =$	6
$17 + 1 =$	17
$15 - 9 =$	13

Umsebenzi Wokubakhulisa 4.14

Zama ukwenza lezi zibalo ezisemabhulokhini.

+	8	1	10
2			
4			
6			
8			
10			

Umsebenzi Wokubakhulisa 4.15

Bangaki \triangle obabonayo?

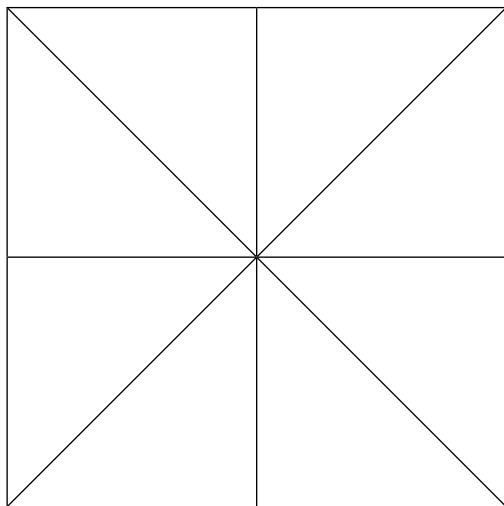

Onxantathu abayi-12 Onxantathu abayi-16

Onxantathu abayi-13 Onxantathu abayi-14

Umsebenzi Wokubakhulisa 4.16

Qondanisa izinombolo namagama ezinombolo.

Izinombolo	Amagama ezinombolo
8	Kubili
10	Yisikhombisa
9	Yisishiyagalombili
7	Yisishiyagalolunye
2	Yishumi
4	Kuthathu
3	Kune

Umsebenzi Wokubakhulisa 4.13: Izimpendulo

Qondanisa izinkinga ezisebhulokhini A nezimpendulo ezisebhulokhini B.

A	B
$5 + 14 =$	18
$20 - 2 =$	16
$16 - 3 =$	19
$12 + 6 =$	10
$16 + 0 =$	18
$10 + 7 =$	18
$14 - 4 =$	6
$17 + 1 =$	17
$15 - 9 =$	13

Umsebenzi Wokubakhulisa 4.14: Izimpendulo

Zama ukwenza lezi zibalo ezisemabhulokhini.

+	8	1	10
2	10	3	12
4	12	5	14
6	14	7	16
8	16	9	18
10	18	11	20

Umsebenzi Wokubakhulisa 4.15: Izimpendulo

Bangaki \triangle obabonayo?

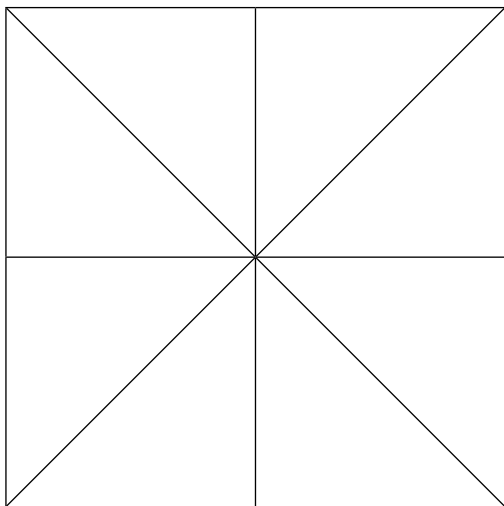

Onxantathu abayi-16

Umsebenzi Wokubakhulisa 4.16: Izimpendulo

Qondanisa izinombolo namagama ezinombolo.

Izinombolo	Amagama ezinombolo
8	Yishiyagalombili
10	Yishumi
9	Yishiyagalolunye
7	Yisikhombisa
2	Kubili
4	Kune
3	Kuthathu

Umsebenzi Wokubakhulisa 4.17

Qedela ithebhula ngokuthi wenze izibalo.

+	5	4	2
1			
2			
3			
4			
5			
6			
7			
8			
9			
10			

Umsebenzi Wokubakhulisa 4.18

Qedela leli phethini.

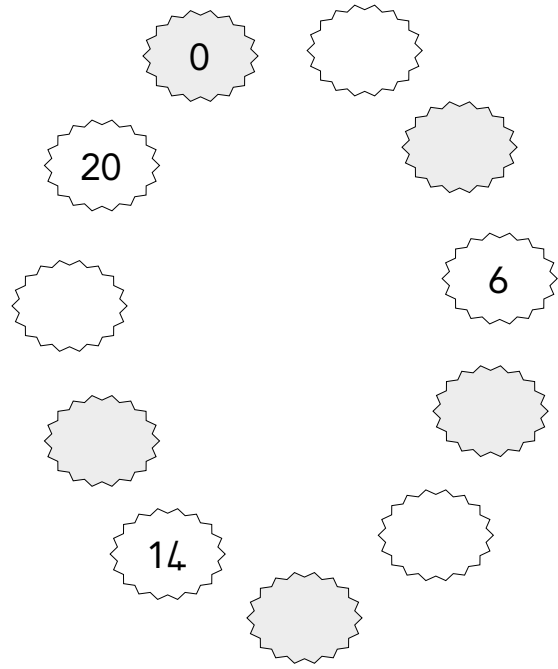

Umsebenzi Wokubakhulisa 4.19

Hlanganisa amachashazi asedayisini bese ugcwalisa izimpendulo.

Kuzoba kungaki?

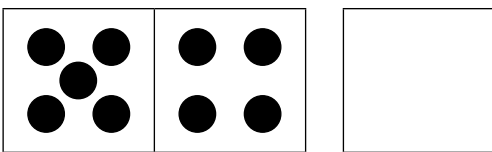

Kuzoba kungaki?

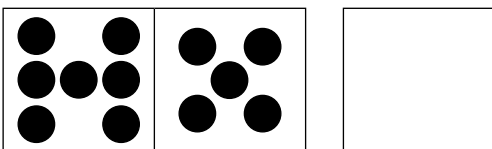

Kuzoba kungaki?

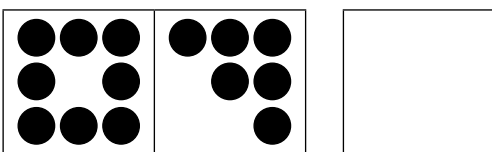

Umsebenzi Wokubakhulisa 4.20

Hlanganisa inombolo ephakathi nezinye izinombolo.

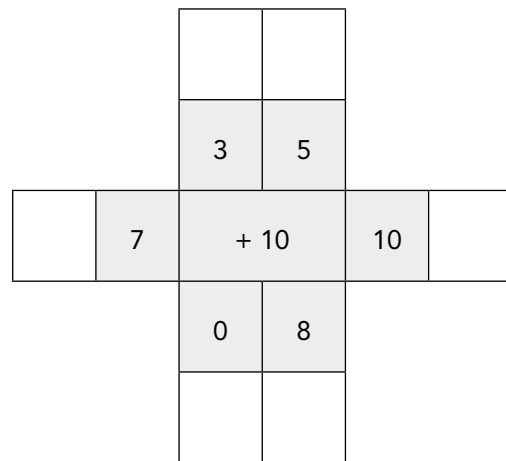

Umsebenzi Wokubakhulisa 4.17: Izimpendulo

Qedela ithebhula ngokuthi wenze izibalo.

+	5	4	2
1	6	5	3
2	7	6	4
3	8	7	5
4	9	8	6
5	10	9	7
6	11	10	8
7	12	11	9
8	13	12	10
9	14	13	11
10	15	14	12

Umsebenzi Wokubakhulisa 4.18: Izimpendulo

Qedela leli phethini.

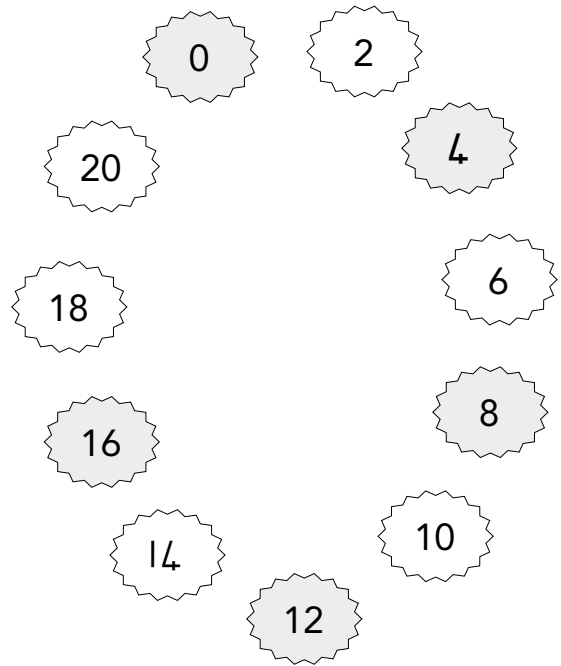

Umsebenzi Wokubakhulisa 4.19: Izimpendulo

Hlanganisa amachashazi asedayisini bese ugqwalisa izimpendulo.

Kuzoba kungaki?

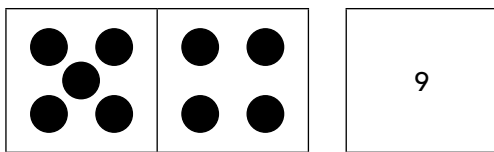

Kuzoba kungaki?

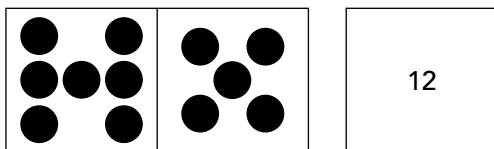

Kuzoba kungaki?

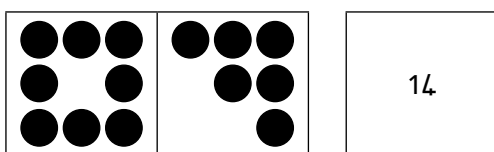

Umsebenzi Wokubakhulisa 4.20: Izimpendulo

Hlanganisa inombolo ephakathi nezinye izinombolo.

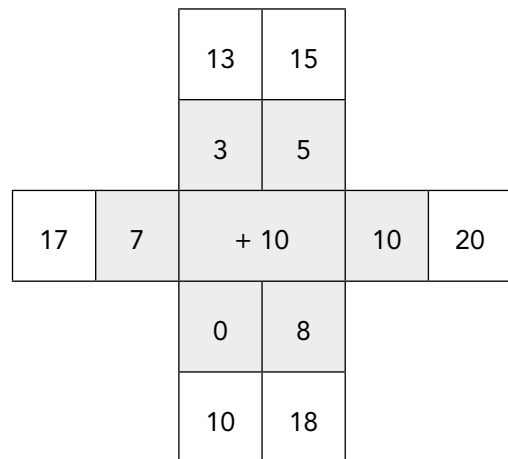

Umsebenzi Wokubakhulisa 4.21

Bala okulandelayo bese udweba umugqa uye empendulweni.

$14 + 1 =$

23

$3 + 20 =$

15

$17 - 3 =$

12

$19 - 7 =$

14

Umsebenzi Wokubakhulisa 4.22

Hlanganisa izinombolo ukuthola inombolo ephakathi.

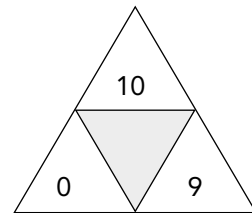
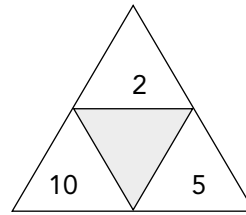
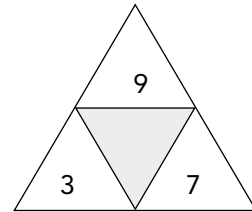
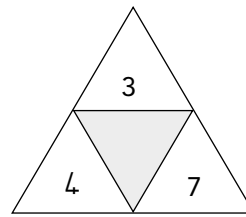

Umsebenzi Wokubakhulisa 4.23

Inombolo ekunhlangothi-sithupha ngamunye yakhiwa ukuhlanganisa izinombolo ezikhlangothi-sithupha ababili abangezansi kwawo. Bala izinombolo ezidingekayo.

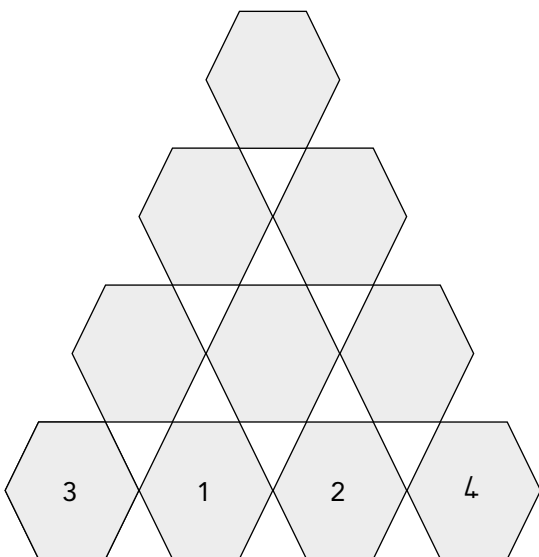

Umsebenzi Wokubakhulisa 4.24

Bala umugqa ngamunye wephazili. Gcwalisa izimpendulo. Bala ikholamu ngayinye yephazili.

4	+	2	=	
+		+		+
3	+	7	=	
=		=		=
	+		=	

Umsebenzi Wokubakhulisa 4.21: Izimpendulo

Bala okulandelayo bese udweba umugqa uye empendulweni.

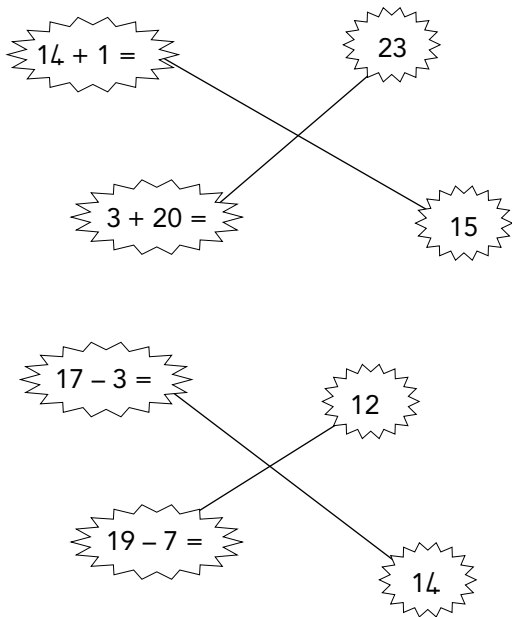

Umsebenzi Wokubakhulisa 4.22: Izimpendulo

Hlanganisa izinombolo ukuthola inombolo ephakathi.

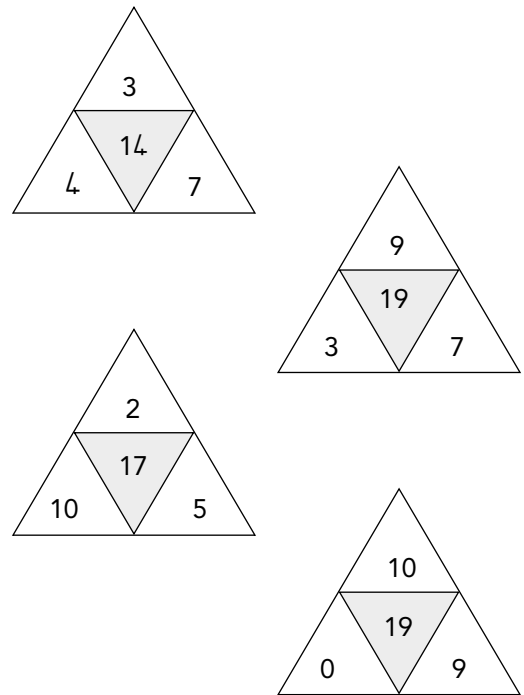

Umsebenzi Wokubakhulisa 4.23: Izimpendulo

Inombolo ekunhlangothi-sithupha ngamunye yakhiwa ukuhlanganisa izinombolo ezikhlangothi-sithupha ababili abangezansi kwawo. Bala izinombolo ezidingekayo.

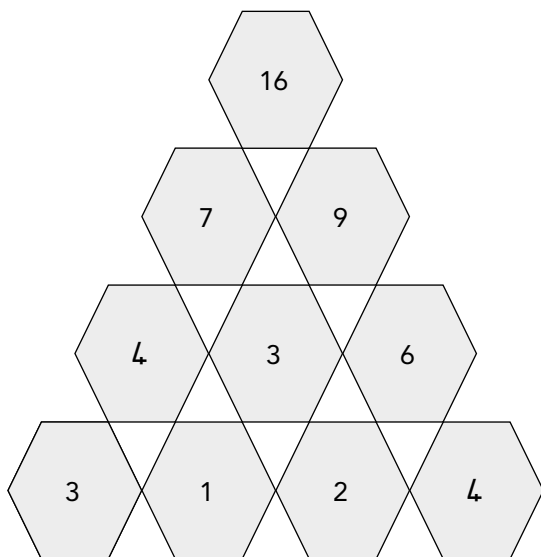

Umsebenzi Wokubakhulisa 4.24: Izimpendulo

Bala umugqa ngamunye wephazili. Gcwalisa izimpendulo. Bala ikholamu ngayinye yephazili.

4	+	2	=	6
+		+		+
3	+	7	=	10
=		=		=
7	+	9	=	16

Umsebenzi Wokubakhulisa 4.25

Ubona okusaqanda okungaki?

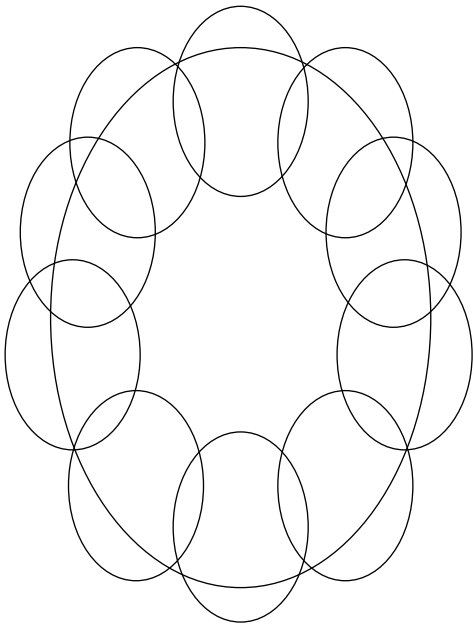

11 24 14

Umsebenzi Wokubakhulisa 4.26

Kungaki  okubonayo?

Kungaki  okubonayo?

Kungaki  okubonayo?

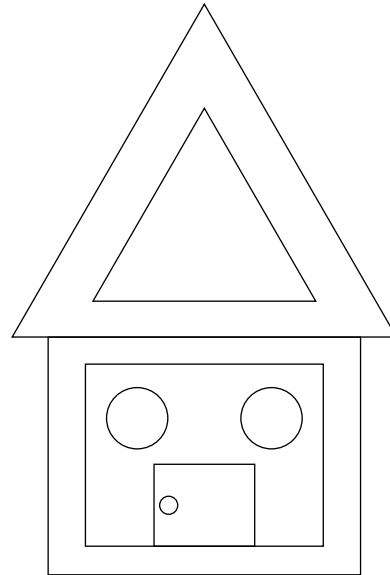

Umsebenzi Wokubakhulisa 4.27

Nikeza izimo ezahlukahlukene amagama.

La magama azokusiza:
unxantathu, isiyingi, isikwele.



Umsebenzi Wokubakhulisa 4.28

Sebenzisa lezi zimo ukudweba isithombe.

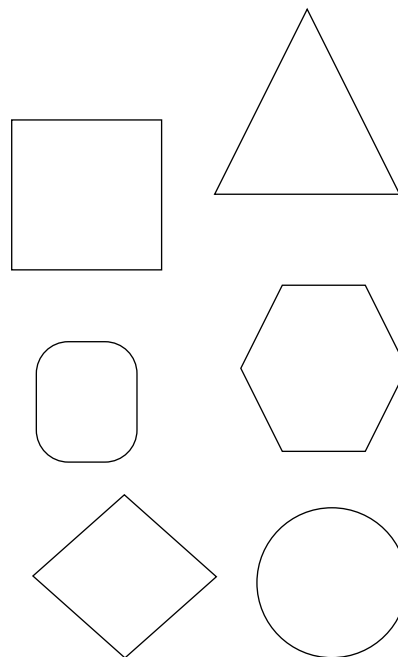

Umsebenzi Wokubakhulisa 4.25: Izimpendulo

Ubona okusaqanda okungaki?

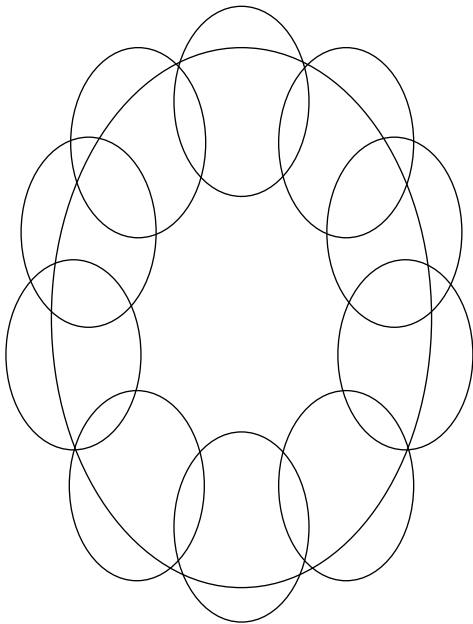

11 24 14

Umsebenzi Wokubakhulisa 4.26: Izimpendulo

Kungaki  okubonayo? (3)

Kungaki  okubonayo? (3)

Kungaki  okubonayo? (2)

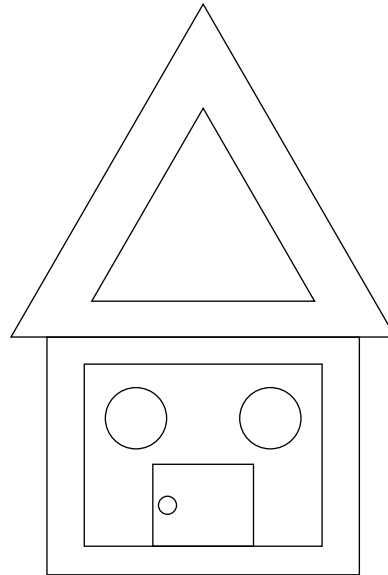

Umsebenzi Wokubakhulisa 4.27: Izimpendulo

Nikeza izimo ezahlukahlukene amagama.

La magama azokusiza:
unxantathu, isiyingi, isikwele.

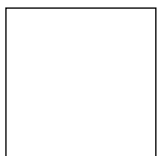

isikwele

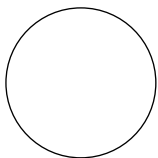

isiyingi

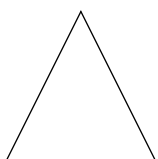

unxantathu

Umsebenzi Wokubakhulisa 4.28: Izimpendulo

Sebenzisa lezi zimo ukudweba isithombe.

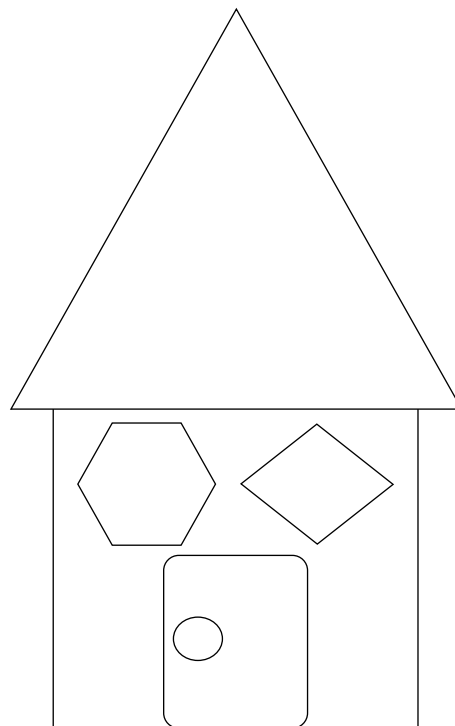

Umsebenzi Wokubakhulisa 4.29

Hlanganisa umugqa wezinombolo ngamunye uthole impendulo.

Umsebenzi Wokubakhulisa 4.30

Bhala igama lenombolo ngayinye kulezi ezilandelayo.

8	
2	
3	
7	
9	
10	
5	
4	
1	
6	

Umsebenzi Wokubakhulisa 4.31

Hlanganisa nokuyi-10 bese udweba impendulo yakho ngakwesokudla.

Umsebenzi Wokubakhulisa 4.32

Iyiphi inombolo enkulu?
Kokeleza inombolo enkulu.

- | | | |
|----|------|----|
| 10 | noma | 14 |
| 12 | noma | 9 |
| 15 | noma | 5 |
| 16 | noma | 20 |
| 0 | noma | 13 |
| 17 | noma | 7 |
| 20 | noma | 19 |
| 5 | noma | 11 |
| 10 | noma | 11 |

Umsebenzi Wokubakhulisa 4.29: Izimpendulo

Hlanganisa umugqa wezinombolo ngamunye uthole impendulo.

Umsebenzi Wokubakhulisa 4.30: Izimpendulo

Bhala igama lenombolo ngayinye kulezi ezilandelayo.

8	yisishiyagalombili
2	kubili
3	kuthathu
7	yisikhombisa
9	yisishiyagalolunye
10	yishumi
5	kuhlanu
4	kune
1	kunye
6	yisithupha

Umsebenzi Wokubakhulisa 4.31: Izimpendulo

Hlanganisa nokuyi-10 bese udweba impendulo yakho ngakwesokudla.

Umsebenzi Wokubakhulisa 4.32: Izimpendulo

Iyiphi inombolo enkulu?
Kokeleza inombolo enkulu.

- | | | |
|------|------|------|
| 10 | noma | (14) |
| (12) | noma | 9 |
| (15) | noma | 5 |
| 16 | noma | (20) |
| 0 | noma | (13) |
| (17) | noma | 7 |
| (20) | noma | 19 |
| 5 | noma | (11) |
| 10 | noma | (11) |



Jika iMfundo
what I do matters

Jik'iMfundo is a programme to improve learning outcomes, funded by the National Education Collaboration Trust, the KwaZulu-Natal Department of Education and others.

THE PROGRAMME TO IMPROVE LEARNING OUTCOMES

The Shed
The Pines
9 Gordon Hill Road
Parktown
2193

Tel: +27 10 880 2431

Email: admin@pilo.co.za

ISBN: 978-1-990918-03-2