

1

**GRADE
MATHEMATICS**

TEACHER TOOLKIT

**CAPS Aligned
Lesson Plans
and Resources**

TERM 3



Jika iMfundo
what I do matters

ENDORSED BY



GRADE 1

Mathematics

Teacher Toolkit:
CAPS Aligned Lesson Plans
and Resources

TERM 3

Acknowledgement:

The lesson plans and resources in this document were initially developed by the Gauteng Department of Education as part of the Gauteng Primary Literacy and Mathematics Strategy. They are being used in KwaZulu-Natal under a memorandum of agreement between the two provinces. They have been revised for the context of KZN on the advice of district and provincial officials.

Published in 2020 by Jika iMfundo.

Jik'iMfundo is a programme to improve learning outcomes, funded by the National Education Collaboration Trust, the KwaZulu-Natal Department of Education and others.

The Programme to Improve Learning Outcomes (PILO)
The Shed, The Pines, 9 Gordon Hill Road, Parktown, 2193
Tel: + 27 10 880 2431
Email: admin@pilo.co.za

© The National Education Collaboration Trust (NECT)

A partnership involving business, civil society, government and labour that strives to improve education outcomes.

The National Education Collaboration Trust
Ground Floor, Block D, Lakefield Office Park, 272 West Avenue, Centurion, 0163
Tel: +27 12 752 6200
Email: info@nect.org.za
Web: www.nect.org.za

No part of this publication may be reproduced without prior permission from the NECT.

ISBN: 978-1-990904-94-3

Materials development by the PILO team along with representatives from the districts and province.

Publishing management by The Word Horse, www.wordhorse.co.za
Design by COMPRESS.dsl, www.compressdsl.com
Typesetting by The Maas Group, www.themaasgroup.com

CONTENTS

About the Lesson Plans and Resources _____	2	Week 6 _____	68
Lesson Plan Outline _____	5	Lesson 21: Data _____	68
Week 1 _____	8	Lesson 22: Data _____	71
Lesson 1: Number 11 _____	8	Lesson 23: Money and change _____	74
Lesson 2: Number 12 _____	11	Lesson 24: Money and change _____	77
Lesson 3: Number 13 _____	14	Week 7 _____	80
Lesson 4: Number 14 _____	17	Lesson 25: Money – addition and subtraction _____	80
Week 2 _____	20	Lesson 26: Geometric patterns _____	83
Lesson 5: Number 15 _____	20	Lesson 27: Patterns – tens, fives and twos up to 50 _____	86
Lesson 6: Length _____	23	Lesson 28: Patterns – fives and tens up to 80 _____	89
Lesson 7: Place value – decompose numbers 11–15 _____	26	Week 8 _____	92
Lesson 8: Place value – decompose numbers 11–15 _____	29	Lesson 29: Patterns – twos and tens up to 80 _____	92
Week 3 _____	32	Lesson 30: Repeated addition up to 15 – fives _____	95
Lesson 9: Place value – decompose numbers 11–15 _____	32	Lesson 31: Repeated addition up to 15 – twos _____	98
Lesson 10: Time _____	35	Lesson 32: Symmetry _____	101
Lesson 11: Addition up to 15 – counting on _____	38	Week 9 _____	104
Lesson 12: Addition – building up and breaking down _____	41	Lesson 33: Grouping _____	104
Week 4 _____	44	Lesson 34: Sharing _____	107
Lesson 13: Subtraction – number lines and counting back _____	44	Lesson 35: Grouping and sharing _____	110
Lesson 14: Subtraction – counting back _____	47	Lesson 36: 3-D objects – slide and roll _____	113
Lesson 15: Addition and subtraction _____	50	Week 10 _____	116
Lesson 16: Doubles _____	53	Lesson 37: 3-D objects – size _____	116
Week 5 _____	56	Lesson 38: Building with 3-D objects _____	119
Lesson 17: Doubles _____	56	Lesson 39: Capacity _____	122
Lesson 18: Halves _____	59	Lesson 40: Views _____	125
Lesson 19: Halves and doubles _____	62	Printable Resources _____	128
Lesson 20: Mass _____	65		

ABOUT THE LESSON PLANS AND RESOURCES

The lesson plans and resources in this book are part of the Teacher Toolkit for Mathematics Grade 1 Term 3. The other documents in the toolkit are:

- a CAPS Aligned Planner, Tracker and Assessment Resources
- a bilingual CAPS Learner Activity Book
- a bilingual Dictionary of Mathematical Terms

A variety of printable resources that you can copy for yourself and/or your learners are included at the end of the lesson plans in this book. They include:

- Resource sheets:** These comprise a variety of teaching and learning aids that are needed in certain lessons. The specific resource sheet, and the number of copies needed, is noted in the relevant lesson plan and in the tracker so that you can prepare them in advance.
- Mental mathematics challenge cards:** A pack of eight mental mathematics challenge cards (solutions are provided) is included to allow for routine weekly mental mathematics activities that you can record.
- Enrichment activity cards:** A pack of 32 enrichment activity cards (solutions are provided) are included for learners who complete the day's classwork activities ahead of the class.

A. About the lesson plans

The lesson plans give detailed information about how to teach a CAPS-aligned lesson every day. By following the lesson plans, you will ensure that you cover the content and assessment tasks specified in the curriculum and give your learners the best possible chance of developing the knowledge and skills required for Mathematics in this grade.

1. Curriculum alignment

The lessons are sequenced according to the topics in the CAPS and weighted according to requirements given there, and the programme of assessment is

accommodated. Every lesson shows the CAPS content and skill being focussed on in the lesson.

2. Links to the DBE workbooks

Links are given in the lessons to all appropriate DBE worksheets. Note that the pages referred to are all from the 2017 edition of the DBE workbook. This changes very little from year to year, but if you use a different edition of the workbook, you should check that the worksheet on the same page in this different edition is still appropriate for your purpose.

Bilingual learner material is provided in the LoLT of the school in accordance with the Foundation Phase language policy.

3. Broad overview of the content of the lesson plans

Each lesson plan provides a set of steps to guide you in delivering the lesson. In addition, it contains learner activities that will help learners develop the concepts and skills set for the lesson. These include the required daily mental mathematics activity, whole class oral activities led by the teacher, classwork and homework activities, as well as answers for these. All the classwork and homework activities are also given in the Learner Activity Books, so that learners do not need to waste time copying them down. In Grade 1, learners write in in these activity books, and so need a new one each term. In the other grades, activity books should not be written in and should be returned at the end of each term for use the following year.

4. Assessment

The programme of assessment suggested in the lesson plans and tracker is adaptable and can be adjusted to comply with the CAPS as amended by Circular S1 of 2017 and provincial responses to this. The lesson plans and tracker provide a number

of resources to support both formal and informal assessment in this programme, as noted below:

- Oral and practical activities which you can use to assess learners as you observe and interact with them in class are provided in the tracker. Rubrics and checklists with criteria for this assessment are provided in the tracker, at the end of the table for the week in which the assessment is suggested.
- There is an item bank of written assessment questions, with marking memos in the tracker. Items that are relevant to a specific lesson are noted in the resources column for the lesson in the tracker.
- A complete overview of the programme of assessment for the term is given in the tracker. This shows you when it is suggested you carry out both formal (and informal) assessment tasks which are oral, practical and written. This will assist you in planning and monitoring your assessment programme.
- There is also recommended mark record sheet in the tracker. This has been drawn up to assist you as you record your marks on SA-SAMS.

5. Managing the lesson programme

A set of orientation activities on eight different topics aligned with the CAPS baseline assessment requirements is provided for the start of the term. You should use all or a selection of these activities in the first week of term before the formal teaching of the numbered lesson plans begins.

The formal curriculum for Term 3 of Grade 1 is covered in a set of 40 numbered, fully developed lesson plans, paced to cover a 50-day teaching term. There are four such lesson plans each week for ten weeks of the term. There is no formal numbered lesson plan for the fifth lesson each week; instead, it is assigned for you to use for a variety of purposes. You can use this time to catch up, remediate or consolidate the content covered in the week's formal lessons. Learners could complete the worksheets from the DBE Workbook related to topics taught in the week if they did not manage to do them in the course of the week.

Each lesson is designed to last 90 minutes. If your school's timetable has different period lengths, you will have to adjust the amount of work done in each lesson to accommodate this. However, each school

should allow seven hours for Mathematics each week, and it should be possible to fit in all the work for the week, even if the lengths of periods are not the same as in the lesson plans.

6. Sequence adherence and pacing

Each lesson and its contents have been carefully sequenced. It is therefore important that lessons are not skipped. Should you miss a Mathematics lesson for any reason, you should continue the next day from where you last left off. Do not leave a lesson out. You may need to speed up the pace of delivery to catch up a missed lesson by covering the lesson concept content of two consecutive days in one day. To do this you could cut out or cut back on some of the routine activities like mental mathematics or homework reflection to save time until you are back on track with the expected delivery of the plans. You need to prepare very well as this will help you to manage the full set of lessons at the appropriate pace.

7. Lesson preparation

The lesson plans provide a detailed lesson design for you to follow. However, to deliver the lessons successfully **you must do the necessary preparation yourself**. The information below outlines some key aspects of preparation.

- a) **Term focus:** Start by looking at the CAPS document and **orientating** yourself to the CAPS content focus for the term. It is important that you are clear about the content focus, as this will frame everything you do in your Mathematics lessons during the term.
- b) **Prepare resources:** The resources needed for each lesson are listed in each lesson plan and in the tracker. It is very important that you check what is required for each lesson ahead of time, so that you have all your resources ready for use every day (e.g. counters, number boards, paper cut-outs, examples of shapes, etc.).
 - **Your lessons will not succeed if you have not prepared properly for them.**
 - If you do not have all the necessary resources readily available, see how best you can improvise, e.g. get learners to collect bottle tops or small stones to be used for counting, or make your own flard cards/number boards using pieces of cardboard and a marker pen.

- Collect empty cool drink cans, cereal boxes, washing powder boxes, plastic bottles, etc. for the **shop activity** in the week long in advance, so that you have all the necessary goods to stock your shop.
 - Use newspapers and magazines to cut out pictures that could be used in your teaching. If you have access to the internet, search for and print out pictures that you may need to use as illustrations in your lessons.
- c) **Prepare for the written classwork and homework activities:** When preparing your lessons, check the lesson activity requirements. In some instances you will need to write information or draw some diagrams on the board that you will use while you do the interactive whole-class-teaching component of the lesson. Also mark the homework activities as often as you can, so that you can give useful feedback to the learners each day, and be aware of any difficulties learners are having as soon as they become apparent.
- d) **Prepare to teach the concepts and skills associated with the lesson topic:** Think carefully about what it is that you will teach your learners in the lesson. Prepare a short introduction to the topic, so that you can explain it in simple terms to your learners. Make sure you have prepared for the teaching of the concepts before you teach – you need to be able to explain new Mathematics content and skills to the learners. Be sure you have gone through the oral teaching activities provided in the lesson plans. Also make sure that you have thought about how to use the resources in the lesson effectively. This preparation needs to be done in advance, so that you do not waste time during the lesson. Be sure you are familiar with the sequence of activities in the lesson plan. Prepare yourself to assist learners with any questions they might have during the lesson. Also give some thought to how you will accommodate learners with barriers to learning.
- e) **Lesson pace:** Think about how much time you will spend on each activity. It is important to plan how you will manage the pace of the lesson carefully; otherwise you will not manage to cover all the lesson content. Not all learners work at the same pace. You need to determine the pace – be guided by the average learner and the recommendations in the lesson plans. Be careful not to slow down to the pace of the slowest learners as this will disadvantage the other learners.
- f) **Organisation of learners:** Think about how you will organise learners when they do the classwork activities. Will they work alone, in pairs or in small groups? How will you organise the pairs or groups if you choose to use them? You need to organise the learners quickly at the beginning of the lesson, so that you do not waste too much time on this.
- g) **Inclusive education:** Consider the needs of any learners with barriers to learning in your class, and how best you can support them. The DBE has published some excellent materials to support you in working with learners with learning barriers. Two such publications are:
- Directorate Inclusive Education, Department of Basic Education (2011) *Guidelines for Responding to Learner Diversity in the Classroom Through Curriculum and Assessment Policy Statements*. Pretoria. www.education.gov.za, www.thutong.doe.gov.za/InclusiveEducation.
 - Directorate Inclusive Education, Department of Basic Education (2010) *Guidelines for Inclusive Teaching and Learning. Education White Paper 6. Special needs education: Building an inclusive education and training system*. Pretoria. www.education.gov.za, www.thutong.doe.gov.za/InclusiveEducation.

LESSON PLAN OUTLINE

Lesson Plan Outline

Each lesson plan has several components. Information about each is given in the table below. This information tells you how to use each of the components of the lesson plans and how they fit together to create a well-paced and properly scaffolded Mathematics lesson each day. You need to read this outline as you prepare each lesson until you are fully familiar with the general lesson plan components, pace and structure.

Lesson topic	Each lesson has a topic with specific detail about the day's lesson.
CAPS topics	The CAPS content related to the day's lesson is given here, together with the reference number for this content in the expansion of content section in the CAPS document for this term. You are encouraged to look at the CAPS to read about the selected curricular topics for the day.
Lesson vocabulary	A list of all mathematical terms used in the lesson is given here. The terms, with full explanations and diagrams, are also provided in the bilingual lesson vocabulary Dictionary that is part of your Toolkit. Go through the lesson vocabulary each day as you prepare for the lesson. These terms are important, as they are the language of Mathematics that each learner needs to learn and understand in order to build a solid foundation and understanding of this subject. It is important to explain these words to your learners and to practise using them with your learners during the lesson.
Prior knowledge and lesson concept	<p>The prior knowledge and lesson concept section gives information about content that learners should have learnt in earlier grades that will be built on in this lesson.</p> <ul style="list-style-type: none"> • You need to read through this section when you do your lesson preparation. • No time is allocated to this part of the plan because it does not form part of the teaching of the day's lesson. • The information about prior knowledge may help you to assist learners who struggle to understand the content of the lesson because there are gaps in the prior knowledge on which the lesson is based. You can use the information about prior knowledge to help you identify such gaps and to diagnose learners' needs in relation to content they do not yet know that may be preventing them from understanding the day's lesson. • Remediation may be needed on prior knowledge that you notice is not properly in place.
Assessment	<p>A reminder to refer to the tracker for the formal oral, practical or written assessment activity for the day is given here.</p> <ul style="list-style-type: none"> • On-going informal and formal oral and practical assessment should be done virtually every day in your class. This means you will record a mark for a few learners for a certain criterion from the curriculum each day. Decide how many learners to assess every day, so that you assess your whole class in the time allocated to each assessment activity. • Rubrics and checklists to guide you in giving ratings for the oral and practical assessments are given in the tracker at the end of the tracker table for each week. Each day you need to use the appropriate rubric or checklist for the assessment activity of that day. • Written test items and their memos are provided in the tracker. Links to these items are given in the resources column of the tracker to show you in which lesson they should best be used. • A <i>Suggested Assessment Record Sheet</i> that you can use to record your term marks is given in the tracker. This sheet aligns with the SA-SAMS.

Lesson Plan Outline

Remediation	<p>Optional as required. You could use these activities to assist slower learners. You need to decide, based on your observation of the learners while you are teaching the lesson content, whether to use this content and with which learners. It will be done with a smaller group of learners/individual learners while the rest of the class is working through the classwork activity from the LAB.</p>
Enrichment	<p>Optional as required. You could use these activities as extra work for fast learners or others interested in doing them.</p> <p>Activities that you can use for enrichment opportunities for learners who have completed the lesson activities are provided in a set of enrichment activity cards at the end of the lesson plan set. Ideally, you should photocopy the enrichment cards, paste them onto cardboard and laminate them, so that they can be used as a resource, not only this year, but in the future as well.</p> <p>Learners should work on these cards independently or with their peers who have also completed the classwork. They may work through the cards in any order. You may need to explain some of the activities to the learners who use them. You should tell them to ask questions if they have any.</p> <p>All learners who show an interest in the enrichment activities should be encouraged to work through the cards.</p>
Mental mathematics (15 minutes)	<p>This is the first component of the lesson. We recommend that you take at most 15 minutes to do the mental mathematics activity. There are two parts to the mental mathematics activity, a counting activity and a set of questions to drill number facts and basic mathematical strategies.</p> <p>Mental mathematics is not a concrete activity (as the title suggests). However, if there are learners who need concrete aids to complete the mental mathematics activities, we suggest that you allow them to use their fingers to count on.</p> <ul style="list-style-type: none"> • Observe which learners struggle with mental activities, and make sure you spend time to assist them to reach the required level of competence by offering remediation activities using concrete aids. • The answers to the ten mental mathematics questions are given in the answer column in the lesson plans. • It would be far better to do all ten questions per day, but if you find that your learners struggle to finish these in ten minutes, do a minimum of five questions. <p>There is a set of mental mathematics challenge cards at the end of the lesson plans. Learners write the answers to the questions given on these cards. We recommend that learners only do written mental mathematics once a week and oral mental mathematics on all the other days. You can use this work to obtain a mental mathematics activity mark each week.</p>
Correction/reflection on homework (15 minutes)	<p>This is the second component of the lesson. We recommend that you take 15 minutes to remediate and correct the previous day's homework. Read out answers to all of the homework questions. Let learners/peers mark the work. Also try to check homework yourself as often as you can.</p> <p>Choose one or two activities that you realise were problematic to work through in full with the whole class. In this part of the lesson you may reflect on the previous day's work. Allow learners the opportunity to write corrections as needed.</p>

Lesson Plan Outline

<p>Lesson content – concept development (30 minutes)</p>	<p>This is the third component of the lesson. It is the body of the lesson, in which learners are introduced to the new work planned for the day. We recommend that you actively teach your class for 30 minutes – going through the activities interactively with your learners.</p> <ul style="list-style-type: none"> • Activities on the content that you will teach with worked examples and suggested explanations are given. These activities have been carefully sequenced and scaffolded so that they support the teaching of the concepts for the day. You should work through each of these with your class. • It is important to manage the pace of the lesson carefully, otherwise you will not manage to cover all the lesson content. Once you have introduced the new concept, work through Activity 1 of the lesson with the whole class (or with learners in groups). Then immediately move on to the next activity, and provide a reasonable time for the learners to complete Activity 2, but do not wait for the last learner to finish before moving on. If there are further activities, continue pacing yourself in this way, so that you work through all of the activities in each lesson. A few activities are marked as <i>optional</i> – these need only be done if you have sufficient time.
<p>Classwork activity from Learner Activity Book (25 minutes)</p>	<p>This is the fourth component of the lesson. We recommend that you allocate 25 minutes to classwork. You could go over one or two of the classwork activities orally with the whole class before allowing the class to complete the activities independently (individually or in groups).</p> <ul style="list-style-type: none"> • Learners do most of the activities in their Mathematics books (an exercise book for learner Mathematics writing activities). Some activities are done in the DBE workbook. • You should allow the learners opportunities to do these activities alone, in pairs and in groups so that they experience working alone as well as with their peers. • Wrap up the lesson each day by giving the learners the answers to the classwork, and allow time for corrections to be written if and when necessary. <p>The bilingual Learner Activity Book contains all of the daily classwork activities.</p>
<p>Homework activity from Learner Activity Book (5 minutes)</p>	<p>This is the fifth and final component of the lesson. We have allocated five minutes to give you time to tell the learners about the homework each day. Here you find a set of activities on the day's content that you can set for your class to do for homework. This is to consolidate the Mathematics that you have taught them that day. Homework also promotes learner writing and development of their mathematical knowledge.</p> <p>The bilingual Learner Activity Book contains all of the daily homework activities.</p>
<p>Reflection</p>	<p>Each day there is a reminder to note your thoughts about the day's lesson. You will use these notes as you plan and prepare for your teaching.</p>

WEEK 1

LESSON 1: NUMBER 11

Teacher's notes

CAPS topics: 1.1 Count objects, 1.2 Count forwards and backwards, 1.16 Mental mathematics, 1.3 Number symbols and number names, 1.4 Describe, compare and order numbers.

Lesson vocabulary: Number symbol 11, before, after, more than, less than, describe, compare, order, number names, number line.

Prior knowledge: Learners should have been taught how to:

- Identify, recognise and read number symbols 1 to 10 and number names one to ten.
- Describe, compare and order a collection of objects up to 10.
- Count out objects reliably to 25

Concepts:

- Recognise, identify, read and write number symbol 11.
- Describe, compare and order numbers up to 11.

Resources: Number symbol 11 and name card eleven (see Term 1 *Printable Resources*), Unifix blocks, sticks, elastic bands, magazines/newspapers, tracing sheet with number symbols 11 (see *Printable Resources*) for learners to trace.

DBE workbook activities relevant to this lesson:

- DBE Worksheet 65 (pp. 2 and 3).

Assessment: Refer to the tracker for today's formal/informal oral, practical or written assessment activity.

Remediation: Ask the learners to give you/count out eleven objects, such as counters/books/bookcases. Instruct the learners to make a group of ten and have one left over. They then count the objects again. Learners can make the number symbol using little stones. Learners then trace over their number symbol with their finger. Stress the starting point and direction of writing the symbol.

Enrichment: See enrichment activity cards.

1. Mental maths

1.1 Counting (5 minutes)

- Count forwards in units, e.g. 10, 11, 12, 13, etc.

1.2 Recall and strategies (10 minutes)

	Which is less?	Answer
1.	1 or 2?	1
2.	9 or 3?	3
3.	11 or 6?	6
4.	2 or 0?	0
5.	8 or 7?	7

	Which is more?	Answer
6.	11 or 5?	11
7.	4 or 10?	10
8.	6 or 1?	6
9.	8 or 7?	8
10.	3 or 1?	3

2. Correction/reflection on homework (15 minutes)

Reflection/remediation based on previous day's work/homework.

3. Lesson content – concept development (30 minutes)

The first five lessons extend the learners' knowledge of numbers and number names up to the number 15. You will see that the activities in each lesson are designed to be similar – in each lesson learners will work with concrete counters (Unifix blocks and sticks). Each time they have to group ten counters together and then observe what is left over. The scaffolded steps guide the learners to use the language of place value, with reference to the concrete activities that they have just done. The repetitive pattern of speech used each time the concrete activities are done will help learners to establish the concept of number being established – how to recognise, name and write numbers which are a few units bigger than ten (which means they are now learning about place value and tens and units) – the number which is the focus of today's lesson is the number 11.

Activity 1: Learners work in groups

Give each learner (or each group of learners) eleven Unifix blocks and eleven sticks.

- Ask the learners to make one train of ten Unifix blocks.
- Ask: *How many single blocks are left over?* (1)
- *What can you tell me about the Unifix?* (There is one train of ten blocks and one single block.)
- *We can say eleven is ten and one.*
- Now ask the learners to make one bundle of ten sticks tied together with an elastic band.
- *How many single sticks are left over?* (1) (Note that working with elastic bands might be dangerous.)
- *What can you tell me about the sticks?* (There is one bundle of ten sticks and one single stick.)
- *We can say: Eleven is ten and one.*
- Show that you have the same number of Unifix blocks and sticks. Both show the number 11. Both show that eleven is $10 + 1$.

Activity 2: Whole class activity

Put the number symbol and name card on the board.

- Point to the number eleven and ask: *What number symbol do you see?* (11)
- Still pointing to the number symbol, explain to the learners that this is how we write the number symbol.
- Stress the starting point and direction of writing the symbol.
- The learners write the number symbol in the air, write it on the back of the learner sitting next to them, write it on their desk using their fingers, and write it on their slates.
- Point to the number name card on the board. Read it to the class and then read it together with the class.

Activity 3: Whole class activity (Optional if time allows)

Draw a 0–20 number line on the board for this activity.

- Ask the learners to put their finger on number 11.
- What can you tell me about the number 11? Encourage learners to use the language before, after, more than and less than.
- If learners struggle to use the language themselves, you can prompt them to do it by asking questions such as:
 - *Which number comes before 11?* (10)
 - *Which number comes after 11?* (12)
 - *Which number is 1 less than 11?* (10)
 - *Which number is 1 more than 11?* (12)
 - *Which number is 2 less than 11?* (9), etc.

4. Classwork activity (25 minutes) (See next page)

5. Homework activity (5 minutes) (See next page)

6. Reflection on lesson

Term 3 Lesson 1: Number 11

Classwork

1. Trace the symbols.

11 11 11 11 11 11 11 11 11 11 11 11 11

2. Tear little bits of paper from a magazine/newspaper and collage the number symbol **11** in your maths books.
3. Cut out eleven pictures from a magazine and paste them next to your collage. Group the pictures, i.e. ten together on the left and one on the right.
The eleven pictures do not have to be identical but they should be of the same type of object, e.g. eleven pictures of cars which do not have to look exactly the same.
4. Fill in the missing numbers:
- a) __, 11 (10)
 - b) __, 10, __ (9, 11)
 - c) 9, __, __, 12 (10, 11)
 - d) 8, __, 10, __, 12 (9, 11)
 - e) 7, 8, __, __, 11 (9, 10)

Homework

1. Draw eleven counters. Draw a circle around ten of the counters. Below your picture write the symbol **11**.

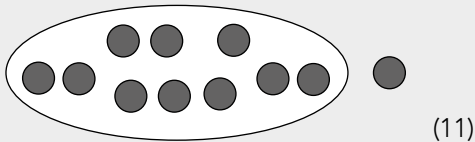

2. Draw eleven sticks. Draw a circle around ten of the sticks. Below your picture write the symbol **11**.

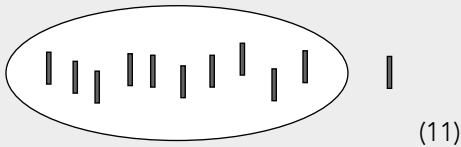

LESSON 2: NUMBER 12

Teacher's notes

CAPS topics: 1.1 Count objects, 1.2 Count forwards and backwards, 1.16 Mental mathematics, 1.3 Number symbols and number names, 1.4 Describe, compare and order numbers.

Lesson vocabulary: Number symbol 12, before, after, more than, less than, forwards, backwards, describe, order, compare.

Prior knowledge: Learners should have been taught how to:

- Identify, recognise and read number symbols 1 to 11.
- Identify, recognise and read number names one to ten.
- Describe, compare and order a collection of objects up to 11.
- Count out objects reliably to 25.

Concepts:

- Recognise, identify, read and write number symbol 12.
- Describe, compare and order numbers up to 12.

Resources: Number symbol 12 and name card twelve (see Term 1 *Printable Resources*), Unifix blocks, sticks, elastic bands, magazines/newspapers, tracing sheet with number symbols 12 (see *Printable Resources*) for learners to trace.

DBE workbook activities relevant to this lesson:

- DBE Worksheet 66 (pp. 4 and 5).

Assessment: Refer to the tracker for today's formal/informal oral, practical or written assessment activity.

Remediation: Ask the learners to give you/count out twelve objects, such as counters/books/pencils. Instruct the learners to make a group of ten and have two left over. They then count the objects again. Learners can make the number symbol using little stones. Learners then trace over their number symbol with a finger. Stress the starting point and direction of writing the symbol.

Enrichment: See enrichment activity cards.

1. Mental maths

1.1 Counting (5 minutes)

- Count forwards and backwards in 1s from 1 to 60, starting from any given number.

1.2 Recall and strategies (10 minutes)

Write the numbers 0 to 11 on the board in a random order. Ask the learners to choose a number less than 10. Ask the learners to tell the person sitting next to them how many less their number is than 11. Repeat with other examples. For example, *Choose a number more than 6/less than 9, etc.*

2. Correction/reflection on homework (15 minutes)

Reflection/remediation based on previous day's work/homework.

3. Lesson content – concept development (30 minutes)

The scaffolded steps in this lesson again guide the learners to use the language of place value, with reference to the concrete activities that they have just done. The repetitive pattern of speech used each time will help learners to establish the concept of number being established – the number which is the focus of today's lesson is the number 12.

Activity 1: Learners work in groups

Give each learner (or each group of learners) twelve Unifix blocks and twelve sticks.

- Ask the learners to make one train of ten Unifix blocks.
- *How many single blocks are left over? (2)*
- *What can you tell me about the Unifix? (There is one train of ten blocks and two single blocks are left over.)*
- *We can say that twelve is ten and two.*
- Ask the learners to make one bundle of ten sticks tied together with an elastic band/string.
- *How many single sticks are left over? (2) (Note that it may be dangerous to work with elastic bands.)*
- *What can you tell me about the sticks? (There is one bundle of ten sticks and two single sticks.)*
- *We can say: Twelve is ten and two.*
- Show that you have the same number of Unifix blocks and sticks. Both show the number 12. Both show that twelve is $10 + 2$.

Activity 2: Whole class activity

Put the number symbol and name card on the board.

- Point to the number twelve card and ask: *What number symbol do you see? (12)*
- Still pointing to the number symbol, explain to the learners that this is how we write the number symbol.
- Stress the starting point and direction of writing the symbol.
- The learners write the number symbol in the air, write it on the back of the learner sitting next to them, write it on the desk with their fingers, and write it on their chalkboards.
- Point to the number name card on the board. Read it to the class and then read it together with the class.

Activity 3: Whole class activity (Optional if time allows)

Draw a 0–20 number line on the board for this activity.

- Ask the learners to put their finger on number 12.
- *What can you tell me about the number 12?* Encourage learners to use the language before, after, more than and less than.
- If learners struggle to use the language themselves, you can prompt them to do it by asking questions such as:
 - *Which number comes before 12? (11)*
 - *Which number comes after 12? (13)*
 - *Which number is 1 less than 12? (11)*
 - *Which number is 1 more than 12? (13)*
 - *Which number is 2 less than 12? (10), etc.*

4. Classwork activity (25 minutes) (See next page)

5. Homework activity (5 minutes) (See next page)

6. Reflection on lesson

Term 3 Lesson 2: Number 12

Classwork

1. Trace the symbols.



2. Tear little bits of paper from a magazine/newspaper and collage the number symbol **12** in your maths books.
3. Cut out twelve pictures from a magazine and paste them next to your collage. Group the pictures, i.e. ten together on the left and two on the right.
The twelve pictures do not have to be identical but they should be of the same type of object. For example, twelve pictures of cars which do not have to look exactly the same.
4. Fill in the missing numbers:
a) __, 12 (11)
b) __, 11, __ (10, 12)
c) 9, __, __, __, 13 (10, 11, 12)
d) 9, __, 11, __, 13 (10, 12)
e) 7, 8, __, __, 11, __ (9, 10, 12)

Homework

1. Draw twelve counters. Draw a circle around ten of the counters. Below your picture write the symbol **12**.

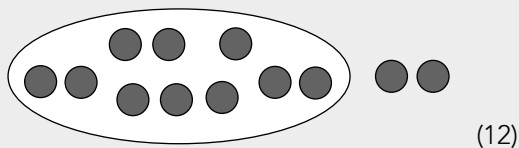

2. Draw twelve sticks. Draw a circle around ten of the sticks. Below your picture write the symbol **12**.

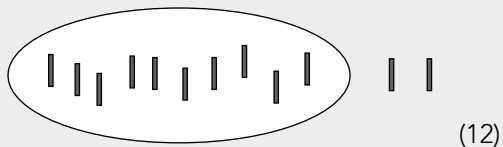

LESSON 3: NUMBER 13

Teacher's notes

CAPS topics: 1.1 Count objects, 1.2 Count forwards and backwards, 1.16 Mental mathematics, 1.3 Number symbols and number names, 1.4 Describe, compare and order numbers.

Lesson vocabulary: Number symbol 13, before, after, more than, less than, forwards, backwards, describe, order, compare.

Prior knowledge: Learners should have been taught how to:

- Identify, recognise and read number symbols 1 to 12.
- Identify, recognise and read number names one to ten.
- Describe, compare and order a collection of objects up to 12.
- Count out objects reliably to 25.

Concepts:

- Recognise, identify, read and write number symbol 13.
- Describe, compare and order numbers up to 13.

Resources: Number symbol 13 and name card thirteen (see Term 1 *Printable Resources*), Unifix blocks, sticks, elastic bands, magazines/newspapers, tracing sheet with number symbols 13 (see *Printable Resources*) for learners to trace.

DBE workbook activities relevant to this lesson:

- DBE Worksheet 67 (pp. 6 and 7).

Assessment: Refer to the tracker for today's formal/informal oral, practical or written assessment activity.

Remediation: Ask the learners to give you/count out thirteen objects, such as counters/books/book bags. Instruct the learners to make a group of ten and have three left over. They then count the objects again. Learners can make the number symbol using little stones. Learners then trace over their number symbol with a finger. Stress the starting point and direction of writing the symbol.

Enrichment: See enrichment activity cards.

1. Mental maths

1.1 Counting (5 minutes)

- Count forwards and backwards in tens, e.g. 10, 20, 30, ... ; 40, 30, 20, 10, 0.

1.2 Recall and strategies (10 minutes)

Write the numbers 0 to 11 on the board in a random order. Ask the learners to choose a number less than 12. Ask the learners to tell the person sitting next to them how many less their number is than 12. Repeat with other examples, e.g. *Choose a number more than 10/less than 10*, etc.

2. Correction/reflection on homework (15 minutes)

Reflection/remediation based on previous day's work/homework.

3. Lesson content – concept development (30 minutes)

The scaffolded steps in this lesson again guide the learners to use the language of place value. The repetitive pattern of speech used each time will help learners to establish the concept of number being established – the number which is the focus of today's lesson is the number 13. The third activity has been marked optional. You should try to refer to a number line in a few of these lessons on numbers 11–15 as a number line helps establish the relative position to numbers and creates an opportunity for other incidental learning about the properties of number and about scale.

Activity 1: Learners work in groups

Give each learner (or each group of learners) thirteen Unifix blocks and thirteen sticks.

- Ask the learners to make one train of ten Unifix blocks.
- *How many single blocks are left over?* (3)
- *What can you tell me about the Unifix?* (There is one train of ten blocks and three single blocks are left over.)
- *We can say that thirteen is ten and three.*
- Ask the learners to make one bundle of ten sticks tied together with an elastic band.
- *How many single sticks are left over?* (3)
- *What can you tell me about the sticks?* (There is one bundle of ten sticks and three single sticks.)
- *We can say: Thirteen is ten and three.*
- Show that you have the same number of Unifix blocks and sticks. Both show the number 13. Both show that thirteen is $10 + 3$.

Activity 2: Whole class activity

Put the number symbol and name card on the board.

- Point to the number thirteen card and ask: *What number symbol do you see?* (13)
- Still pointing to the number symbol, explain to the learners that this is how we write the number symbol.
- Stress the starting point and direction of writing the symbol.
- The learners write the number symbol in the air, write it on the back of the learner sitting next to them, write it on the desk with their fingers, and write it on their slates.
- Point to the number name card on the board. Read it to the class and then read it together with the class.

Activity 3: Whole class activity (Optional if time allows)

Draw a 0–20 number line on the board for this activity.

- Ask the learners to put their fingers on number 13.
- *What can you tell me about the number 13?* Encourage learners to use the language before, after, more than and less than.
- If learners struggle to use the language themselves, you can prompt them to do it by asking questions such as:
 - *Which number comes before 13?* (12)
 - *Which number comes after 13?* (14)
 - *Which number is 1 less than 13?* (12)
 - *Which number is 1 more than 13?* (14)
 - *Which number is 2 less than 13?* (11), etc.

4. Classwork activity (25 minutes) (See next page)

5. Homework activity (5 minutes) (See next page)

6. Reflection on lesson

Term 3 Lesson 3: Number 13

Classwork

1. Trace the symbols.

13 13 13 13 13 13 13 13 13 13 13 13

2. Tear little bits of paper from a magazine/newspaper and collage the number symbol **13** in your maths books.
3. Cut out thirteen pictures from a magazine and paste them next to your collage. Group the pictures, i.e. ten together on the left and three on the right.
The thirteen pictures do not have to be identical but they should be of the same type of object. For example, thirteen pictures of flowers which do not have to look exactly the same.
4. Fill in the missing numbers:
- __, 13 (12)
 - __, 12, __ (11, 13)
 - 10, __, __, 13 (11, 12)
 - 9, __, 11, __, __, 14 (10, 12, 13)
 - 9, 10, __, __, __ (11, 12, 13)

Homework

1. Draw thirteen counters. Draw a circle around ten of the counters. Below your picture write the symbol **13**.

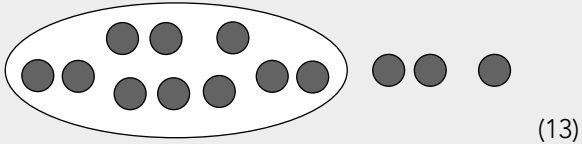

2. Draw thirteen sticks. Draw a circle around ten of the sticks. Below your picture write the symbol **13**.

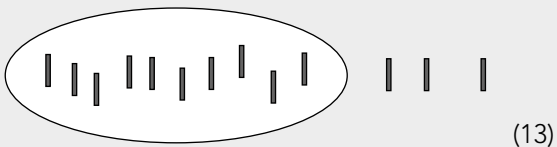

LESSON 4: NUMBER 14

Teacher's notes

CAPS topics: 1.1 Count objects, 1.2 Count forwards and backwards, 1.16 Mental mathematics, 1.3 Number symbols and number names, 1.4 Describe, compare and order numbers.

Lesson vocabulary: Number symbol 14, before, after, more than, less than, starting point, direction.

Prior knowledge: Learners should have been taught how to:

- Identify, recognise and read number symbols 1 to 13.
- Identify, recognise and read number names one to ten.
- Describe, compare and order a collection of objects up to 13.
- Count out objects reliably to 25.

Concepts:

- Describe, compare and order a collection of objects and numbers using language (1–14).

Resources: Number symbol 14 and number name card fourteen (see Term 1 *Printable Resources*), Unifix blocks, sticks, elastic bands, magazines/newspapers, tracing sheet with number symbols 14 (see *Printable Resources*) for learners to trace.

DBE workbook activities relevant to this lesson:

- DBE Worksheet 68 (pp. 8 and 9).

Assessment: Refer to the tracker for today's formal/informal oral, practical or written assessment activity.

Remediation: Ask the learners to give you/count out fourteen objects, e.g. 14 counters/14 books/14 suitcases. Instruct the learners to make a group of ten and have four left over. They then count the objects again. Learners can make the number symbol using little stones. Learners then trace over their number symbol with a finger. Stress the starting point and direction of writing the symbol.

Enrichment: See enrichment activity cards.

1. Mental maths

1.1 Counting (5 minutes)

- Count forwards and backwards in 1s from 1 to 65, starting from any given number.

1.2 Recall and strategies (10 minutes)

	Order these numbers from the biggest to the smallest	Answer
1.	0, 8, 2	8, 2, 0
2.	5, 2, 7	7, 5, 2
3.	0, 4, 10	10, 4, 0
4.	6, 2, 7	7, 6, 2
5.	9, 2, 4	9, 4, 2

	Order these numbers from the biggest to the smallest	Answer
6.	2, 8, 5	8, 5, 2
7.	0, 6, 3	6, 3, 0
8.	10, 3, 8	10, 8, 3
9.	0, 8, 6	8, 6, 0
10.	6, 5, 11	11, 6, 5

2. Correction/reflection on homework (15 minutes)

Reflection/remediation based on previous day's work/homework.

3. Lesson content – concept development (30 minutes)

The scaffolded steps in this lesson again guide the learners to use the language of place value. The repetitive pattern of speech used each time will help learners to establish the concept of number being established – the number which is the focus of today's lesson is the number 14.

Activity 1: Learners work in groups

Give each learner (or each group of learners) fourteen Unifix blocks and fourteen sticks and an elastic band.

- Ask the learners to make one train of ten Unifix blocks. Ask: *How many single blocks are left over?* (4)
- Ask: *What can you tell me about the Unifix?* (There is one train of ten blocks and four single blocks are left over.)
- We can say: *Fourteen is ten and four.*
- Instruct the learners to make one bundle of ten sticks tied together with an elastic band. *How many single sticks are left over?* (4)
- Ask: *What can you tell me about the sticks?* (There is one bundle of ten sticks and four single sticks.)
- We can say: *Fourteen is ten and four.*
- Show that you have the same number of Unifix blocks and sticks. Both show the number 14. Both show that fourteen is $10 + 4$.

Activity 2: Whole class activity

Put the number symbol and name card on the board.

- Point to the number fourteen card and ask: *What number symbol do you see?* (14)
- Still pointing to the number symbol, explain to the learners that this is how we write the number symbol. Stress the starting point and direction of writing the symbol.
- After showing them how to write the number symbol, learners write the number symbol in the air, write it on the back of the learner sitting next to them, write it on the desk with their fingers, and write it on their slates.
- Point to the number name card on the board. Read it to the class and then read it together with the class.

Activity 3: Whole class activity (Optional if time allows)

Draw a 0–20 number line on the board for this activity.

- Ask learners to put their finger on number 14. Encourage learners to use the language before, after, more than and less than.
- If learners struggle to use the language themselves, you can prompt them to do it by asking questions such as:
 - *Which number comes before 14?* (13)
 - *Which number comes after 14?* (15)
 - *Which number is 1 less than 14?* (13)
 - *Which number is 1 more than 14?* (15)
 - *Which number is 2 less than 14?* (12)
 - *Which number is the same as 14?* (14)

4. Classwork activity (25 minutes) (See next page)

5. Homework activity (5 minutes) (See next page)

6. Reflection on lesson

Term 3 Lesson 4: Number 14

Classwork

1. Trace the symbols.

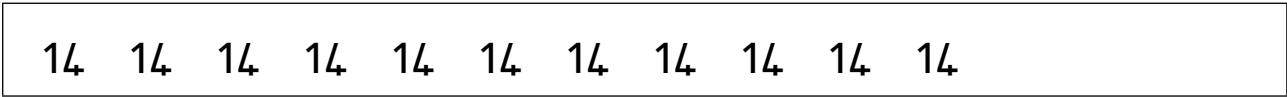

2. Tear little bits of paper from a magazine/newspaper and collage the number symbol **14** in your maths books.
3. Cut out fourteen pictures from a magazine and paste them next to your collage. Group the pictures, i.e. ten together on the left and four on the right.
The fourteen pictures do not have to be identical but they should be of the same type of object.
E.g. fourteen pictures of flowers which do not have to look exactly the same.
4. Fill in the missing numbers:
- a) __, 14 (13)
 - b) __, 13, __ (12, 14)
 - c) 11, __, __, 14 (12, 13)
 - d) 10, __, 12, __, __, 15 (11, 13, 14)
 - e) 10, 11, __, __, __ (12, 13, 14)

Homework

1. Draw fourteen counters in your book. Draw a circle around ten of the counters. Below your picture write the symbol **14**.

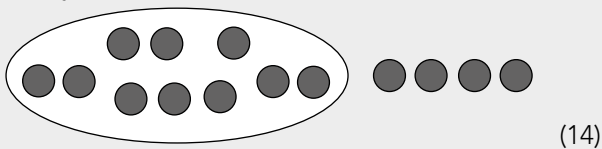

2. Draw fourteen sticks in your book. Draw a circle around ten of the sticks. Below your picture write the symbol **14**.

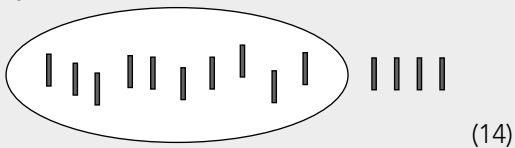

WEEK 2

LESSON 5: NUMBER 15

Teacher's notes

CAPS topics: 1.1 Count objects, 1.2 Count forwards and backwards, 1.16 Mental mathematics, 1.3 Number symbols and number names, 1.4 Describe, compare and order numbers, 1.6 Problem solving techniques.

Lesson vocabulary: Number symbol 15, more than, less than, before, after, starting point, direction.

Prior knowledge: Learners should have been taught how to:

- Identify, recognise and read number symbols 1 to 14 and number names to ten.
- Describe, compare and order a collection of objects up to 14.
- Count out objects reliably to 25.

Concepts:

- Describe, compare and order a collection of objects and numbers using language (1–15).

Resources: Number symbol 15 and number name card fifteen (see Term 1 *Printable Resources*), Unifix blocks, sticks, elastic bands, magazines/newspapers, tracing sheet with number symbols 15 (see *Printable Resources*) for learners to trace.

DBE workbook activities relevant to this lesson:

- DBE Worksheet 69 (pp. 10 and 11).

Assessment: Refer to the tracker for today's formal/informal oral, practical or written assessment activity.

Remediation: Ask the learners to give you/count out fifteen objects, such as fifteen counters/fifteen books/fifteen suitcases. Instruct the learners to make a group of ten and have five left over. They then count the objects again. Learners can make the number symbol using little stones. Learners then trace over their number symbol with a finger. Stress the starting point and direction of writing the symbol.

Enrichment: See enrichment activity cards.

1. Mental maths

1.1 Counting (5 minutes)

- Count forwards and backwards in units, e.g. 21, 22, 23, 24, 25, ...; 20, 19, 18, 17, 16,

1.2 Recall and strategies (10 minutes)

	Put these numbers in order from the smallest to the biggest	Answer
1.	10, 7, 11	7, 10, 11
2.	9, 6, 3	3, 6, 9
3.	10, 6, 12	6, 10, 12
4.	9, 1, 3	1, 3, 9
5.	8, 3, 0	0, 3, 8

	Put these numbers in order from the smallest to the biggest	Answer
6.	9, 2, 4	2, 4, 9
7.	11, 9, 4	4, 9, 11
8.	3, 2, 7	2, 3, 7
9.	3, 1, 9	1, 3, 9
10.	11, 9, 10	9, 10, 11

2. Correction/reflection on homework (15 minutes)

Reflection/remediation based on previous day's work/homework.

3. Lesson content – concept development (30 minutes)

The scaffolded steps in this lesson again guide the learners to use the language of place value. The repetitive pattern of speech used each time will help learners to establish the concept of number being established – the number which is the focus of today's lesson is the number 15.

Activity 1: Learners work in groups

Give each learner (or each group of learners) fifteen Unifix blocks and fifteen sticks and an elastic band.

- Ask the learners to make one train of ten Unifix.
- *How many single blocks are left over?* (5)
- *What can you tell me about the Unifix?* (There is one train of ten blocks and five single blocks are left over.)
- *We can say that fifteen is ten and five.*
- Ask the learners to make one bundle of ten sticks tied together with an elastic band.
- *How many single sticks are left over?* (5)
- *What can you tell me about the sticks?* (There is one bundle of ten sticks and five single sticks are left over.)
- *We can say: Fifteen is ten and five.*
- Show that you have the same number of Unifix blocks and sticks. Both show the number 15. Both show that fifteen is $10 + 5$.

Activity 2: Whole class activity

Put the number symbol and name card on the board.

- Point to the number fifteen card and asks: *What number symbol do you see?* (15)
- Still pointing to the number symbol, explain to the learners that this is how we write the number symbol.
- Stress the starting point and direction of writing the symbol.
- The learners write the number symbol in the air, write it on the back of the learner sitting next to them, write it on the desk with their fingers, and write it on their chalkboards.
- Point to the number name card on the board. Read it to the class and then read it together with the class.

Activity 3: Whole class activity (Optional if time allows)

Draw a 0–20 number line on the board for this activity.

- Ask learners to put their finger on number 15. Encourage learners to use the language before, after, more than and less than.
- If learners struggle to use the language themselves, you can prompt them to do it by asking questions such as:
 - *Which number comes before 15?* (14)
 - *Which number comes after 15?* (16)
 - *Which number is 1 less than 15?* (14)
 - *Which number is 1 more than 15?* (16)
 - *Which number is 2 less than 15?* (13)
 - *Which number is the same as 15?* (15)

4. Classwork activity (25 minutes) (See next page)

5. Homework activity (5 minutes) (See next page)

6. Reflection on lesson

Term 3 Lesson 5: Number 15

Classwork

1. Trace the symbols.

15 15 15 15 15 15 15 15 15 15 15

2. Tear little bits of paper from a magazine/newspaper and collage the number symbol **15** in your maths books.
3. Cut out fifteen pictures from a magazine and paste them next to your collage. Group the pictures, i.e. ten together on the left and five on the right.
The fifteen pictures do not have to be identical but they should be of the same type of object. E.g. fifteen pictures of faces which do not have to look exactly the same.
4. Fill in the missing numbers:
- __, 15 (14)
 - __, 14, __ (13, 15)
 - 12, __, __, 15 (13, 14)
 - 11, __, 13, __, __, 16 (12, 14, 15)
 - 11, 12, __, __, __, 16 (13, 14, 15)

Homework

1. Draw fifteen counters in your book. Draw a circle around ten of the counters. Below your picture write the symbol **15**.

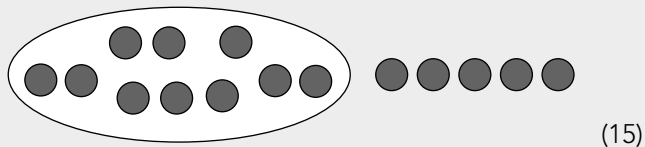

2. Draw fifteen sticks in your book. Draw a circle around ten of the sticks. Below your picture write the symbol **15**.

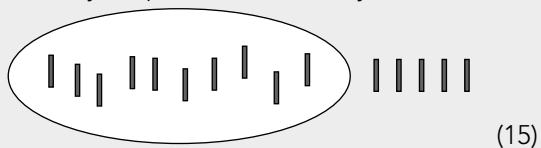

LESSON 6: LENGTH

Teacher's notes

CAPS topics: 1.1 Count objects, 1.2 Count forwards and backwards, 1.16 Mental mathematics, 4.2 Length.

Lesson vocabulary: Length, estimate, measure, long/longer than, short/shorter than, taller than, wider than, narrower than, thicker than, thinner than, order, record, non-standard measures.

Prior knowledge: Learners should have been taught how to:

- Compare and order the length, height or width of two or more objects by placing them next to each other.
- Use language to talk about the comparison.

Concepts:

- Compare and order the length of two or more objects by placing them next to each other.
- Use language to talk about the comparison.
- Estimate, measure, compare, order and record length using non-standard measures.

Resources: Pencils, objects to be measured, e.g. books, suitcases, desks, mats, classroom, etc.

DBE workbook activities relevant to this lesson:

- DBE Worksheet 74 (pp. 20 and 21).
- DBE Worksheet 96 (pp. 64 and 65).

Assessment: Refer to the tracker for today's formal/informal oral, practical or written assessment activity.

Remediation: Give the learners 2 pencils (of equal length) and a book to measure. Help them to measure the height of the book by placing one pencil and then the next, counting them and then lifting one and placing it next and so on. The learners should then say: *The book is ___ pencils high.* Then help the learners to measure the width of their book. The learners should then say: *The book is ___ pencils wide.* Give the learners another book to measure, but assist them in estimating the height and width first, based on their previous measurements.

Enrichment: See enrichment activity cards.

1. Mental maths

1.1 Counting (5 minutes)

- Count forwards in tens, e.g. 10, 20, 30, ..., etc.

1.2 Recall and strategies (10 minutes)

	Which number is 2 more than:	Answer
1.	5	7
2.	3	5
3.	11	13
4.	9	11
5.	0	2

	Which number is 2 more than:	Answer
6.	8	10
7.	7	9
8.	10	12
9.	4	6
10.	6	8

2. Correction/reflection on homework (15 minutes)

Reflection/remediation based on previous day's work/homework.

3. Lesson content – concept development (30 minutes)

In this lesson you consolidate the learners' knowledge and understanding of the concept length. The activities in this lesson call on learners to measure (using non-standard units of measurement) and to compare length using the measurements that they have found. It is important that you *and the learners* speak about the activities using all of the mathematical vocabulary relevant to this lesson.

Use the *Dictionary of Mathematical Terms* to check how to use non-standard units of measurement if necessary.

Activity 1: Learners work in groups

Instruct each learner to get three pencils.

- First, learners will measure the width of their desks using a pencil as a non-standard unit.
- *Choose one of your pencils and use it to measure the width (←→) of your table.*
- *How many pencils wide is your desk? (My desk is ____ pencils wide).*
- Next, learners use the measurement of the width of the desk to help them estimate the measurement of the height of the desk.
- *If your desk is ____ pencils wide, then how many pencils high do you think your desk is?*
- Assist learners in estimating the height of their desks in pencil lengths.
- Help them to consider how many pencils wide their desk is (use the measurements they found for their desks) so that they give realistic estimates. (Their reasoning could be: My desk is higher than it is wide, so I think I will get more pencil lengths; the measurement of the height will be greater than the measurement of the width of the desk. I think my desk will be ____ pencils high.)
- Now learners check their estimates by measuring.
- Ask the learners to use their pencils to measure the height of their desks. (My desk is ____ pencils high.)
- After the measuring and estimation activities, discuss the comparison between the lengths they have found.
- *Which measurement was greater? The width or the height of the desk? (The height. It was ____ pencils high.)*
- *Which measurement was smaller? The width or the height of the desk? (The width. It was ____ pencils wide.)*
- Recap the problems that arise when you use non-standard units.
- *Did you all get the same answers? (No.)*
- *Why not? (We all used pencils of different lengths and so the measurements we found were not all exactly the same.)*
- *What should we have done differently when we measured in order to all get the same measurement? (We should all have used pencils of the same length.)*

Activity 2: Learners work in groups

Follow the same procedure but measure other objects, e.g. suitcase, chair, mat, door, etc.

- Remind learners to estimate and then measure.
- Remind learners to compare the measurements that they find.
- Talk to the class about the non-standard measurements – this discussion leads into the use of standard measurements which will follow.

4. Classwork activity (25 minutes) (See next page)

5. Homework activity (5 minutes) (See next page)

6. Reflection on lesson

Term 3 Lesson 6: Length

Classwork

1. Answer the questions.

a) What is the length of the table? (3 pencils)

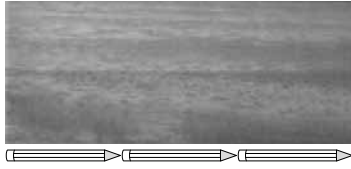

b) What is the width of the table? (2 pencils)



2. How many pencils long is each side?

a)

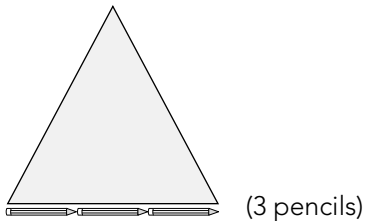

b)

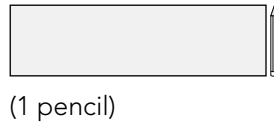

c)

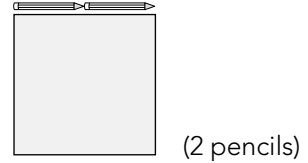

3. Draw the following pictures to show the given lengths: (answers will vary)

a) A box that is two pencils long.

b) A flower that is one pencil tall.

c) A book that is three pencils high.

Homework

(answers will vary)

1. Write the name of the person who is the tallest in your family.
2. Write the name of the person who is the shortest in your family.
3. Draw a picture of yourself and a friend.
4. Write down who is taller and who is shorter.

LESSON 7: PLACE VALUE – DECOMPOSE NUMBERS 11–15

Teacher's notes

CAPS topics: 1.1 Count objects, 1.2 Count forwards and backwards, 1.16 Mental mathematics, 1.5 Place value.

Lesson vocabulary: Group, grouping, break up, tens, units/ones, bundle of, decompose, break down, digit.

Prior knowledge: Learners should have been taught how to:

- Count out objects reliably to 20.
- Count in ones from any number between 0 and 50.
- Read number symbols 0–15.
- Write number symbols 1 to 10.
- Break down numbers in different ways.

Concepts:

- Recognise the place value of numbers 11 to 15.
- Decompose two-digit numbers into ten and ones, e.g. 12 is 10 and 2.

Resources: Counting sticks, elastic bands.

DBE workbook activities relevant to this lesson:

- DBE Worksheet 95 (p. 62).

Assessment: Refer to the tracker for today's formal/informal oral, practical or written assessment activity.

Remediation: Give the learners match sticks and elastic bands. Assist them in counting out 10 match sticks and tying them together. *This is a bundle of ten.* Ask the learners to count out 11 match sticks. Help them to tie 10 together. *This is a bundle of 10 and 1 loose one.* Do the same with 12, 13, 14 and 15 match sticks.

Enrichment: See enrichment activity cards.

1. Mental maths

1.1 Counting (5 minutes)

- Count backwards in tens, e.g. 40, 30, 20,

1.2 Recall and strategies (10 minutes)

	Put these numbers in order from the biggest to the smallest	Answer
1.	10, 7, 11	11, 10, 7
2.	3, 9, 6	9, 6, 3
3.	10, 6, 12	12, 10, 6
4.	9, 1, 3	9, 3, 1
5.	8, 3, 0	8, 3, 0

	Put these numbers in order from the biggest to the smallest	Answer
6.	2, 4, 9	9, 4, 2
7.	7, 9, 3	9, 7, 3
8.	3, 2, 7	7, 3, 2
9.	3, 1, 9	9, 3, 1
10.	11, 9, 10	11, 10, 9

2. Correction/reflection on homework (15 minutes)

Reflection/remediation based on previous day's work/homework.



3. Lesson content – concept development (30 minutes)

This lesson and the two lessons that follow it give you another opportunity to consolidate learners' understanding of the numbers over ten – in terms of place value. You should remember to consistently and repeatedly use the language of place value – tens and units – and show how the number symbol links to the concrete representations they make. One ten (one bundle of ten) is written as a 1 in the tens place.



Consolidating learners' understanding of place value in 2-digit numbers will lay the foundation for bigger numbers that follow.

Activity 1: Learners work in groups

Give each group of learners a pile of 15 sticks.

- Ask learners to count out 11 sticks from their pile. 
- Ask the learners to pick up 10 of the 11 sticks and tie them together with the elastic band. 
- *What can you tell me about the sticks?* (Encourage them to say: We had 11 loose sticks. We tied ten sticks together and now we have one bundle of ten sticks and one loose stick. 11 is one ten and 1 one unit/one.) 
- Write the number 11 on the board. Say the number name, eleven.
- Point out the place values of the two digits in the number 11 – there is one ten and one unit in the number eleven. (Use the words 'tens', 'units'/'ones' and digit when you refer to the number. Learners need to know this mathematical language.)

Activity 2: Learners work in groups

- Ask learners to count out 12 sticks from their pile. 
- Ask the learners to pick up 10 of the 12 sticks and tie them together with the elastic band. 
- *What can you tell me about the sticks?* (Encourage them to say: We had 12 loose sticks. We tied ten sticks together and now we have one bundle of ten sticks and two loose sticks. 12 is one ten and two units/ones.) 
- Write the number 12 on the board. Say the number name, twelve.
- Point out the place values of the two digits in the number 12 – there is one ten and two units in the number twelve. (Remember to use the words 'tens', 'units'/'ones' and digit when you refer to the number to help them to learn the correct mathematical language.)
- Do the same with numbers 13, 14 and 15.

4. Classwork activity (25 minutes) (See next page)

5. Homework activity (5 minutes) (See next page)

6. Reflection on lesson



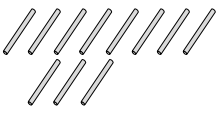
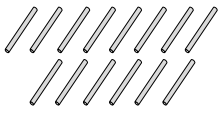
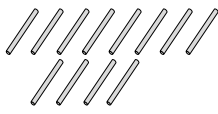
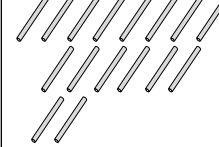
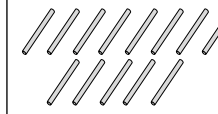

Term 3 Lesson 7: Place value – decompose numbers 11–15

Classwork

1. Draw a circle around ten sticks.

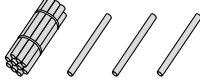
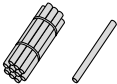

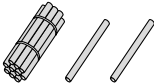
a) 	b) 	c) 	d) 	e) 
--	--	--	---	--

2. Fill in:

a) 	one ten and _____ ones (0)	d) 	one ten and _____ ones (3)
b) 	one ten and _____ ones (1)	e) 	one ten and _____ ones (4)
c) 	one ten and _____ ones (2)	f) 	one ten and _____ ones (5)

Homework

1. Draw sticks to represent the following:

- a) one ten and 2 ones ()
- b) one ten and 5 ones ()
- c) one ten and 3 ones ()

LESSON 8: PLACE VALUE – DECOMPOSE NUMBERS 11-15

Teacher's notes

CAPS topics: 1.1 Count objects, 1.2 Count forwards and backwards, 1.16 Mental mathematics, 1.5 Place value.

Lesson vocabulary: Group, grouping, break up, tens, units/ones, decompose, digit.

Prior knowledge: Learners should have been taught how to:

- Recognise the place value of numbers 11 to 15.
- Decompose two-digit numbers into ten and ones, e.g. 12 is 10 and 2.

Concepts:

- Recognise the place value of numbers 11 to 15.
- Decompose two-digit numbers into ten and ones, e.g. 12 is 10 and 2.

Resources: Unifix blocks, whiteboards/scrap paper.

DBE workbook activities relevant to this lesson:

- DBE Worksheet 95 (p. 63).

Assessment: Refer to the tracker for today's formal/informal oral, practical or written assessment activity.

Remediation: Ask the learners to draw 11 counters.



Assist them to draw a circle around 10 counters. *We can say 11 is 1 ten and 1 unit/one.* Do the same with 12, 13, 14 and 15.

Enrichment: See enrichment activity cards.

1. Mental maths

1.1 Counting (5 minutes)

- Count forwards and backwards in 1s from 0 to 70, starting from any given number.

1.2 Recall and strategies (10 minutes)

	Put these numbers in order from the smallest to the biggest	Answer
1.	0, 8, 2	0, 2, 8
2.	5, 2, 7	2, 5, 7
3.	10, 0, 4	0, 4, 10
4.	6, 2, 7	2, 6, 7
5.	9, 2, 4	2, 4, 9

	Put these numbers in order from the smallest to the biggest	Answer
6.	8, 5, 2	2, 5, 8
7.	0, 6, 3	0, 3, 6
8.	10, 8, 3	3, 8, 10
9.	0, 8, 6	0, 6, 8
10.	11, 6, 5	5, 6, 11

2. Correction/reflection on homework (15 minutes)



Reflection/remediation based on previous day's work/homework.

3. Lesson content – concept development (30 minutes)

Remember in this lesson to use the words 'tens' and 'units'/'ones' when you refer to numbers to explain their value. This will help learners to become familiar with this important mathematical language.

Activity 1: Learners work in groups

Give each group of learners 15 Unifix blocks.

- Ask them to count out 11 Unifix blocks. 
- Ask the learners to put 10 of the 11 Unifix blocks together to form a tower. 
- *What can you tell me about the Unifix blocks?* (Encourage them to say: We had 11 loose Unifix blocks. We stuck ten Unifix blocks together and now we have one tower of ten Unifix blocks and one loose Unifix block.  11 is one ten and one unit/one.)
- Do the same with numbers 13, 14 and 15.
- Each time, stress the number of tens and the number of units.

Activity 2: Learners work individually

Learners work on whiteboards/scrap paper.

- Ask the learners to draw 12 stars on their whiteboards/scrap paper.
- Say: *Draw a circle around ten stars.*

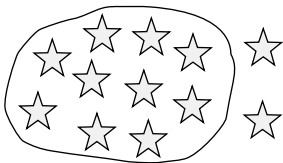

- *How many groups of ten stars did you find?* (One)
- *How many single stars were left over?* (2)
- *What can we say?* (12 is 1 ten and 2 units/ones.)
- Do the same with 11, 13, 14 and 15.
- Each time, ask the learners to tell you what they found – in terms of the number of tens and the number of units.

4. Classwork activity (25 minutes) (See next page)

5. Homework activity (5 minutes) (See next page)

6. Reflection on lesson





Term 3 Lesson 8: Place value – decompose numbers 11–15

Classwork

1. Circle 10 counters and fill in the missing numbers.

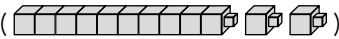

	a) one ten and _____ ones (1 ten and 2 ones)		d) one ten and _____ ones (1 ten and 4 ones)
	b) one ten and _____ ones (1 ten and 0 ones)		e) one ten and _____ ones (1 ten and 1 one)
	c) one ten and _____ ones (1 ten and 3 ones)		f) one ten and _____ ones (1 ten and 5 ones)

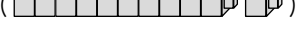
2. Draw Unifix blocks to show the following:

- a) 1 ten and 4 ones ()
- b) 1 ten and 2 ones ()
- c) 1 ten and 0 ones ()
- d) 1 ten and 3 ones ()
- e) 1 ten and 5 ones ()
- f) 1 ten and 1 one ()

Homework

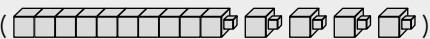
1. Draw Unifix blocks to represent the following:

- a) one ten and 1 one ()
- b) one ten and 4 ones ()
- c) one ten and 2 ones ()

WEEK 3

LESSON 9: PLACE VALUE – DECOMPOSE NUMBERS 11–15

Teacher's notes

CAPS topics: 1.1 Count objects, 1.2 Count forwards and backwards, 1.16 Mental mathematics, 1.5 Place value.

Lesson vocabulary: Group, grouping, decompose, break up, tens, units/ones.

Prior knowledge: Learners should have been taught how to:

- Recognise the place value of numbers 11 to 15.
- Decompose two-digit numbers into ten and ones, e.g. 12 is 10 and 2.

Concepts:

- Recognise the place value of numbers 11 to 15.
- Decompose two-digit numbers into ten and ones, e.g. 12 is 10 and 2.

Resources: Abacus (demonstration and per group of learners, if possible), flard cards (make one set per group of learners – see *Printable Resources*).

DBE workbook activities relevant to this lesson:

- N/A

Assessment: Refer to the tracker for today's formal/informal oral, practical or written assessment activity.

Remediation: Give the learners 15 Unifix blocks. Assist them in counting out 11 Unifix blocks. Ask them to make towers of ten. *How many tens can you make? (One.) How many ones are left loose? (One.)* Point and say: *11 is 1 ten and 1 loose one.* Do the same with 12, 13, 14 and 15.

Enrichment: See enrichment activity cards.

1. Mental maths

1.1 Counting (5 minutes)

- Count in tens, then stop (e.g. at 20) and count on in units, e.g. 10, 20, 21, 22, 23.

1.2 Recall and strategies (10 minutes)

	Which is less?	Answer
1.	11 or 13	11
2.	10 or 11	10
3.	13 or 12	12
4.	3 or 13	3
5.	5 or 8	5

	Which is less?	Answer
6.	9 or 8	8
7.	0 or 8	0
8.	8 or 5	5
9.	11 or 7	7
10.	12 or 6	6

2. Correction/reflection on homework (15 minutes)

Reflection/remediation based on previous day's work/homework.

3. Lesson content – concept development (30 minutes)

This is the third lesson on place value. Remember to use the words 'tens' and 'units'/'ones' when you refer to numbers to explain their value to consolidate this important mathematical language.

Activity 1: Whole class activity

Use the demonstration abacus for this activity. If you don't have an abacus, draw beads on the board and show how to group them into tens and units each time.

- Ask a learner to come to the front of the class and to count 11 beads on the abacus, moving the beads one at a time from left to right.
- When the learner has counted ten ones – there are no beads left on the first rod of the abacus – what must they do?
- Ten ones = 1 ten. You must push back the ten beads you have counted and push out 1 bead on the tens rod.
- Now count one more unit. You have counted 11. The abacus now shows 11 – showing 1 bead on the tens rod and one bead on the units rod.



- In this way the abacus teaches learners and consolidates their understanding of place value.
- Do the same with 12, 13, 14 and 15. Each time you count the beads, when you have counted the first ten, talk about the exchange you have to make in order to push out one bead on the tens rod. *I have counted ten units. I push them back and exchange them for 1 ten. I push out 1 bead on the tens rod.* Then count out the remaining number of beads you have to count on the units rod, according to the total number you are showing. (Use your drawing to show this if you don't have an abacus.)

Activity 2: Learners work in groups

Give each group of learners a set of flard cards. If you do not have an abacus, draw beads on the board to go with this activity, as you did in the first activity.

- Ask a learner to come to the front of the class and to count out 13 on the abacus. The learner should talk about the exchange they make when they get to ten.
- Point at the final display and ask: *How many tens and how many ones do you see?* (1 ten and 3 ones.)
- Ask learners to show the number 13 symbol using flard cards. Some may show a 1 and a 3 (this is not correct), while others may show a 10 and a 3 (this is correct).
- Ask learners to provide their reasons for the way they made up the number 13. (13 is made up of 1 ten and 3 units, so I take a 10 card and a 3 card to show 13.)
- Encourage them to use their abacus (or look at your drawing) to see 1 ten and 3 ones, so that they realize they need the 10 and the 3 place value cards.
- Show learners that they need to place the 3 on the zero to make the symbol 13.
- Then show them how to write down the number sentence as follows:
 $13 = 10 + 3$
- Do the same with 11, 12, 14 and 15.



4. Classwork activity (25 minutes) (See next page)

5. Homework activity (5 minutes) (See next page)

6. Reflection on lesson





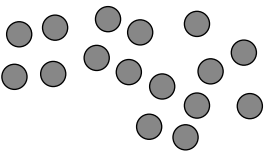
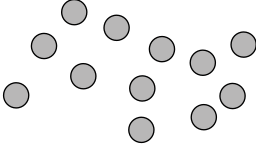
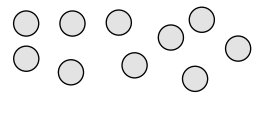
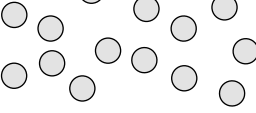
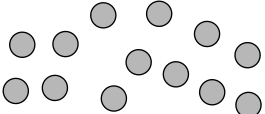
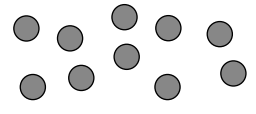

Term 3 Lesson 9: Place value – decompose numbers 11–15

Classwork

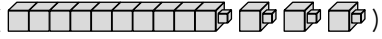
1. Draw a circle to show tens and ones and then fill in the missing numbers.



	a) 15 = __ ten and __ ones (15 = 1 ten and 5 ones)		d) 12 = __ ten and __ ones (12 = 1 ten and 2 ones)
	b) 11 = __ ten and __ ones (11 = 1 ten and 1 one)		e) 14 = __ ten and __ ones (14 = 1 ten and 4 ones)
	c) 13 = __ ten and __ ones (13 = 1 ten and 3 ones)		f) 10 = __ ten and __ ones (10 = 1 ten and 0 ones)

2. Draw Unifix blocks (tens and ones) to show the following numbers:



- a) 13 ()
- b) 11 ()
- c) 10 ()
- d) 15 ()
- e) 12 ()
- f) 14 ()

Homework

1. Fill in:

- a) () 11 = __ (1) ten and __ (1) ones
- b) () 13 = __ (1) ten and __ (3) ones
- c) () 12 = __ (1) ten and __ (2) ones

2. Draw Unifix blocks to show the numbers:

- a) 10 ()
- b) 15 ()
- c) 14 ()

LESSON 10: TIME

Teacher's notes

CAPS topics: 1.2 Count forwards and backwards, 1.16 Mental mathematics, 4.1 Time.

Lesson vocabulary: Time, before, after, next, yesterday, today, tomorrow, morning, afternoon, evening, months, days, faster, slower, this month, last month, next month, longer, shorter.

Prior knowledge: Learners should have been taught how to:

- Sequence events using language such as yesterday, today and tomorrow.
- Compare lengths of time using language: longer, shorter, faster and slower.
- Describe when something happens using language: morning, afternoon, night, early and late.
- Place birthdays on a calendar.

Concepts:

- Talk about the passing of time by ordering regular events from their own lives.
- Use language to talk about the comparisons, e.g. faster/slower and to sequence events such as yesterday, today, tomorrow.
- Use language to describe when something happens, e.g. in the morning.
- Name and sequence days of the week and months of the year.
- Place birthdays on a calendar.

Resources: Day and month flashcards (see *Printable Resources*).

DBE workbook activities relevant to this lesson:

- DBE Worksheet 79 (p. 30).

Assessment: Refer to the tracker for today's formal/informal oral, practical or written assessment activity.

Remediation: Give the learners cards with the names of the days of the week printed on them. Help them to read the names of the days of the week. Then assist them to place the cards in the correct order from Monday to Sunday. Ask questions such as: *Which day comes after Sunday? Which day comes before Thursday? Which day comes between Saturday and Monday?* etc. Show the learners how to use the ordered cards to help them work out the correct answer.

Enrichment: See enrichment activity cards.

1. Mental maths

1.1 Counting (5 minutes)

- Count forwards and backwards in 2s between 0 and 60, e.g. 34, 36, 38 ...

1.2 Recall and strategies (10 minutes)

	Add the following:	Answer
1.	$1 + _ = 4$	3
2.	$2 + _ = 3$	1
3.	$2 + _ = 4$	2
4.	$0 + _ = 3$	3
5.	$2 + _ = 5$	3

	Add the following:	Answer
6.	$3 + _ = 5$	2
7.	$5 + _ = 5$	0
8.	$3 + _ = 4$	1
9.	$1 + _ = 5$	4
10.	$1 + _ = 3$	2

2. Correction/reflection on homework (15 minutes)

Reflection/remediation based on previous day's work/homework.

3. Lesson content – concept development (30 minutes)

There is a lot of vocabulary related to the topic of time. Use this lesson to give learners as many opportunities as possible to use this vocabulary in discussion to help them consolidate their knowledge of the 'time' words (see lesson vocabulary list). The discussion in Activity 1 is to raise awareness that things happen at different times of the day and to familiarise learners with words such as *today, tomorrow, yesterday, morning, afternoon, evening*, etc. Activity 2 is about the days of the week and Activity 3 is about the months of the year.

Activity 1: Whole class activity

- Discuss with the learners: events which happened at school yesterday; events which are happening at school today; and events which will happen at school tomorrow.
- Discuss what the learners did this morning, and what they may be going to do in the afternoon and in the evening at home.

Activity 2: Whole class activity

- Discuss the days of the week. Talk about activities that learners do on the different days of the week.
 - *What day of the week is it today?* (Today is _____ .)
 - *What day of the week was yesterday?* (Yesterday was _____ .)
 - *What day of the week will tomorrow be?* (Tomorrow will be _____ .)
 - *What day of the week comes after Monday?* (Tuesday.)
 - *What day of the week comes before Friday?* (Thursday.)
 - *What day of the week is between Friday and Sunday?* (Saturday.)
- Encourage the learners to read the names of the days of the week.

Activity 3: Whole class activity

- Discuss the months of the year. Talk about activities that learners do in the different months of the year.
 - *What month of the year it is?* (e.g. August.)
 - *What month was before this month?* (July.)
 - *What month will it be after this month?* (September.)
 - *What month is your birthday in?* Allow the learners to tell you their months of birth.
- Encourage the learners to read the names of the months of the year.

4. Classwork activity (25 minutes) (See next page)

5. Homework activity (5 minutes) (See next page)

6. Reflection on lesson

Term 3 Lesson 10: Time

Classwork

(answers will vary)

1. Draw a picture to show what you did before school.
2. Draw a picture of what you will do after school.
3. Write the names of each of the days of the week.
4. Draw a picture to show what you do on each day of the week.
5. Write the names of each of the months of the year.
6. In which month of the year were you born?
7. Draw a picture of a special event that happens in one of the months of the year.
(Optional, depending on time.)

Homework

(answers will vary)

1. What do you do in the morning? Draw a picture of one of the things you do in the morning.

LESSON 11: ADDITION UP TO 15 – COUNTING ON

Teacher's notes

CAPS topics: 1.1 Count objects, 1.2 Count forwards and backwards, 1.16 Mental mathematics, 1.6 Problem-solving techniques, 1.7, 1.13 Addition and subtraction.

Lesson vocabulary: Add, addition, plus, more, altogether, equals, count on, number sentence.

Prior knowledge: Learners should have been taught how to:

- Add and subtract up to 10 using concrete apparatus and pictures.

Concepts:

- Solve problems using concrete apparatus and pictures and explain solutions to problems involving addition with answers up to fifteen.
- Use appropriate symbols (+, =, □).
- Use counting on as a technique when solving problems.

Resources: Unifix blocks, counters, blank number lines (see *Printable Resources*).

DBE workbook activities relevant to this lesson:

- DBE Worksheet 70 (pp. 12 and 13).

Assessment: Refer to the tracker for today's formal/informal oral, practical or written assessment activity.

Remediation: Give each group 15 Unifix blocks. Ask them to show you 7 and 5 is 12. Ask the learners to count.

Learners can first do the addition by counting all: 

1, 2, 3, 4, 5, 6, 7 ...8, 9, 10, 11, 12. Then learners do the addition by counting on:  7 ...8, 9, 10, 11, 12. Guide the learners to give you a number sentence orally: 7 plus 5 equals 12. Do the same with other combinations of 11, 12, 13, 14 and 15.

Enrichment: See enrichment activity cards.

1. Mental maths

1.1 Counting (5 minutes)

- Count forwards and backwards in 10s between 0 and 60.

1.2 Recall and strategies (10 minutes)

	Which number is 2 less than:	Answer
1.	5	3
2.	3	1
3.	11	9
4.	12	10
5.	13	11

	Which number is 2 less than:	Answer
6.	8	6
7.	7	5
8.	10	8
9.	4	2
10.	9	7

2. Correction/reflection on homework (15 minutes)

Reflection/remediation based on previous day's work/homework.

3. Lesson content – concept development (30 minutes)

Learners have been introduced to the concepts of addition and subtraction and might already be starting to become aware of the relationship between these two operations. The next five lessons allow time for these concepts to be consolidated. Initially you deal with the operations separately but as soon as learners start to see that 'counting on' and 'counting back' are related (they do similar things – just one does it forwards and one does it backwards) encourage them to make this link. This leads them to the understanding of the inverse relationship that exists between addition and subtraction.

Activity 1: Learners work in groups

Give each group of learners 10 counters.

- Ask them to put 6 counters on the left hand side of their desk.
- Ask them to explain to you what they now see in front of them.
(●●●●●● and ●●●●).
- Ask: *How many counters do you have altogether in front of you on your desk?*
- *How did you count your counters?* (Some might say: We counted 6, then 7, 8, 9, 10, others might say they counted all of the counters, starting at 1.)
- Encourage them to count on from 6: *Good, so you counted on 4 from the 6.*
- Ask those who counted all of the counters if they can see that it is correct and quicker to count on from the first number rather than to count all of the counters. **(This is an important discussion!)**
- Ask learners to suggest other combinations that make 10.
- E.g. ●●●●●●●● and ●● (8 and 2 is 10.)
- Discuss again: *We can find the answer by counting on.*
- *We can say 8 (starting number) and count on ...9, 10.* (Learners touch and count.)
- Discuss other examples, each time working through counting on from the first of the two numbers.

Activity 2: Whole class activity

- Draw and label a number line on the board from 0–15.

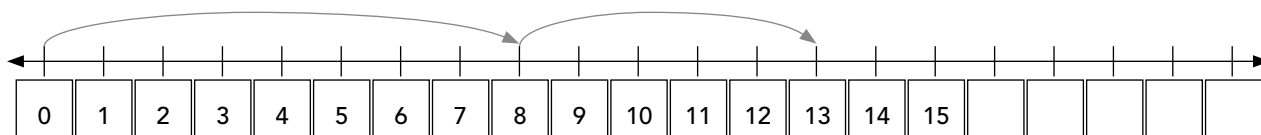

- Ask the learners to show you **8 and 5 is 13** by showing the hops on the number line.
- Starting at 8 will encourage them to **count on** (start from the first number) instead of **count all** (starting at 0).
- *We can find the answer by counting on from the first number.*
- *We can say 8 ...9, 10, 11, 12, 13.* (Learners touch the number line at 8 and then jump up to 9 and then to 10, then to 11, then 12 and then 13.)
- Do the same with other combinations of 6, 7, 8, 9 and 10, pointing to the number line.
- Each time you do an example show the illustration of the addition on the number line.

4. Classwork activity (25 minutes) (See next page)

5. Homework activity (5 minutes) (See next page)

6. Reflection on lesson

Term 3 Lesson 11: Addition up to 15 – counting on

Classwork

1. Draw a picture and write a number sentence:

a) Khwezi has 9 sweets. Thulani has 3 sweets. How many sweets do they have altogether?

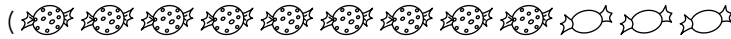
( $(9 + 3 = 12)$)

b) Grace has 8 sweets. Tuli has 6 sweets. How many sweets do they have altogether?

( $(8 + 6 = 14)$)

2. Fill in the numbers on the number line and then write a number sentence for each.

Each number line starts at zero.

a)

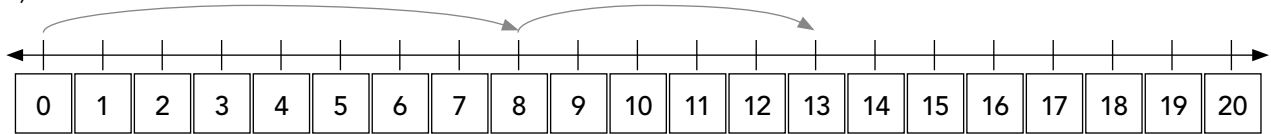

$$\square + \square = \square \quad (8 + 5 = 13)$$

b)

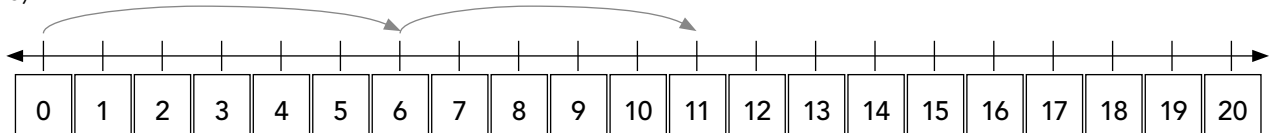

$$\square + \square = \square \quad (6 + 5 = 11)$$

Homework

1. Peter has 5 sweets. Kate has 10 sweets. How many sweets do they have altogether?

( $5 + 10 = 15$)

2. Fill in the numbers on the number line and then write a number sentence for each.

Each number line starts at zero.

a)

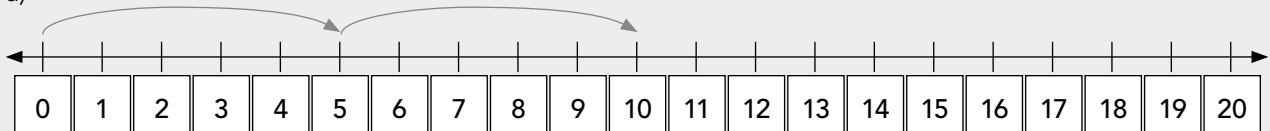

$$\square + \square = \square \quad (5 + 5 = 10)$$

b)

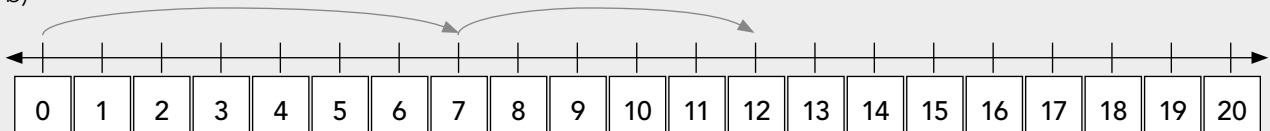

$$\square + \square = \square \quad (7 + 5 = 12)$$

LESSON 12: ADDITION - BUILDING UP AND BREAKING DOWN

Teacher's notes

CAPS topics: 1.1 Count objects, 1.2 Count forwards and backwards, 1.16 Mental mathematics, 1.6 Problem-solving techniques, 1.12 Techniques (methods or strategies) 1.13, 1.17 Addition and subtraction.

Lesson vocabulary: Add, plus, more, altogether, count on, number sentence, addition, equals, building up, breaking down.

Prior knowledge: Learners should have been taught how to:

- Add and subtract up to 10 using concrete apparatus and pictures; Bonds up to 10.
- Add using building up and breaking down of numbers as a technique.

Concepts:

- Solve problems in context and explain own solutions to problems involving addition with answers up to fifteen.
- Use techniques like concrete apparatus, drawing of pictures and building up and breaking down numbers.
- Use appropriate symbols (+, -, =, □).

Resources: Unifix blocks, counters, flard cards (see *Printable Resources*), whiteboards/scrap paper.

DBE workbook activities relevant to this lesson:

- DBE Worksheet 71 (p. 14).

Assessment: Refer to the tracker for today's formal/informal oral, practical or written assessment activity.

Remediation: Give the learners Unifix blocks of different colours.

Help the learners to show you 8 and 6 is 14 using two different colours:

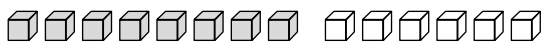

Show learners how to write the number sentence: $8 + 6 = 14$.

Encourage the learners to use their Unifix blocks to make the following sums: $9 + 3 = 12$; $6 + 9 = 15$; $7 + 7 = 14$; $10 + 3 = 13$. Assist the learners in writing down the number sentences too.

Enrichment: See enrichment activity cards.

1. Mental maths

1.1 Counting (5 minutes)

- Count forwards and backwards in 10s between 0 and 70, e.g. 20, 30, 40 ...

1.2 Recall and strategies (10 minutes)

	Which number is bigger?	Answer
1.	5 or 9	9
2.	12 or 9	12
3.	13 or 10	13
4.	14 or 13	14
5.	9 or 14	14

	Which number is bigger?	Answer
6.	8 or 11	11
7.	9 or 7	9
8.	10 or 8	10
9.	5 or 3	5
10.	6 or 8	8

2. Correction/reflection on homework (15 minutes)

Reflection/remediation based on previous day's work/homework.

3. Lesson content – concept development (30 minutes)

Activity 1: Learners work in groups

Give each learner ten counters.

- Give each group of learners ten counters and a set of flard cards from 1 to 10. Ask learners to show you the following combination:

E.g. ● ●●●●●●●●●

- *What can you tell me about your counters?* (1 and 9 is 10.)
- *We can write it like this:* $1 + 9 = 10$
- Ask the learners to show you 1 and 9 is 10 using their flard cards. E.g.

$$\boxed{1} + \boxed{9} = \boxed{10}$$

- Discuss more combinations of ten using pairs of numbers.
- Each time show a display of two numbers that add up to 10 using counters and then show the display of flard cards for the number sentence.
- Discuss with the class that you have made pairs of numbers that build up the number ten.
E.g. $3 + 7 = 10$
- Now look at the number sentence and ask the class: *Can I break down the number ten into smaller parts? How?*
- Based on the activity you have just done, learners should be able to give you pairs of numbers into which the number ten can be broken down. This discussion is to lead learners to the realisation that addition and subtraction are related – they are 'opposite' operations.
- **OPTIONAL:** If the class has responded well to the discussion of numbers using pairs, do the following. However if time is running out, move on to Activity 2.

E.g. ●● ●●● ●●●●●

- *What can you tell me about your counters?* (2 and 3 and 5 is 10.)
- *We can write it like this:* $2 + 3 + 5 = 10$
- Discuss more combinations of ten using three numbers. Discuss that 10 can be built up or broken down into three (or more) numbers.

Activity 2: Learners work in groups

Give each group of learners fifteen Unifix blocks and whiteboards/scrap paper.

- To link this activity to the previous one explain to learners that you have just been working with pairs (or more) of numbers that add up to 10. In this activity you work with pairs of numbers that add up to 15.
- Ask the learners to place their 15 Unifix on the tables in the following manner:
E.g. 
- Encourage the learners to give you a verbal number sentence. (Answer: 1 and 14 is 15.)
- Show the learners how to write the number sentence. (Answer: $1 + 14 = 15$.)
- Do the same with: 2 and 13; 3 and 12; 4 and 11; 5 and 10; 6 and 9; 7 and 8; 8 and 7; 9 and 6; 10 and 5; 11 and 4; 12 and 3; 13 and 2; 14 and 1.
- Similar activities can be done with pairs of numbers that add up to 11, 12, 13, and 14.

4. Classwork activity (25 minutes) (See next page)

5. Homework activity (5 minutes) (See next page)

6. Reflection on lesson

Term 3 Lesson 12: Addition – building up and breaking down

Classwork

1. Write the number sentences:

- a) ●●●●●●●●●●○○○○ (11 + 4 = 15)
- b) ●●●●●●●○○○○○ (8 + 5 = 13)
- c) ●●●●●○○○○○ (6 + 5 = 11)
- d) ●●●●●●●●○○○○ (9 + 4 = 13)
- e) ●●●●●●○○○○○○○ (7 + 7 = 14)

2. Solve the following by drawing a picture:

- a) I have 6 red balls and 6 green balls. How many balls do I have altogether?

●●●●●● ○○○○○○ (6 + 6 = 12)

- b) Mom has 5 red flowers and 8 yellow flowers. How many flowers does she have altogether?

✿✿✿✿✿ ✿✿✿✿✿✿✿✿ (5 + 8 = 13)

Homework

1. Write the number sentences:

- a) ●●●●●●●○○○ (8 + 3 = 11)
- b) ●●●●●○○○○○ (6 + 5 = 11)
- c) ●●●●●●●○○○○○ (8 + 5 = 13)

WEEK 4

LESSON 13: SUBTRACTION – NUMBER LINES AND COUNTING BACK

Teacher's notes

CAPS topics: 1.1 Count objects, 1.2 Count forwards and backwards, 1.16 Mental mathematics, 1.6 Problem-solving techniques, 1.12 Techniques (methods or strategies) 1.13, 1.17 Addition and subtraction.

Lesson vocabulary: Subtract, number sentence, subtraction, take away, equals.

Prior knowledge: Learners should have been taught how to:

- Subtract up to 10 using concrete apparatus and pictures.
- Use bonds up to 10.
- Add using building up and breaking down of numbers as a technique.

Concepts:

- Solve problems in context and explain own solutions to problems involving subtraction with answers up to fifteen.
- Use techniques like concrete apparatus, drawing pictures, building up and breaking down numbers.
- Use appropriate symbols (+, -, =, \square).

Resources: Counters, blank number lines (see *Printable Resources*), whiteboards/scrap paper.

DBE workbook activities relevant to this lesson:

- DBE Worksheet 71 (p. 15).

Assessment: Refer to the tracker for today's formal/informal oral, practical or written assessment activity.

Remediation: Ask learners to put their finger on number 8 on their number line. Ask learners to then jump backwards 4 places. Ask learners what number they landed on. (4) Ask learners to give you the verbal number sentence ($8 - 4 = 4$). Repeat with other numbers.

Enrichment: See enrichment activity cards.

1. Mental maths

1.1 Counting (5 minutes)

- Count forwards and backwards in 2s between 0 and 60, e.g. 22, 24, 26 ...

1.2 Recall and strategies (10 minutes)

	Give a number between the two given numbers. Is there only one number?	Answer
1.	2 and 4?	3
2.	1 and 3?	2
3.	4 and 6?	5
4.	4 and 7?	5 and 6
5.	5 and 8?	6 and 7

	Give a number between the two given numbers. Is there only one number?	Answer
6.	6 and 9?	7 and 8
7.	7 and 10?	8 and 9
8.	6 and 8?	7
9.	7 and 9?	8
10.	0 and 2?	1

2. Correction/reflection on homework (15 minutes)

Reflection/remediation based on previous day's work/homework.

3. Lesson content – concept development (30 minutes)

Activity 1: Whole class activity

Ask learners to each draw a number line on their whiteboards/scrap paper.

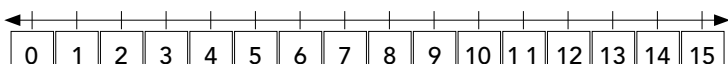

- Ask learners to put their finger on the number **5**.
- Ask learners to jump backwards to 3, counting the jumps as they go. (1, 2 jumps.)
- *How many jumps did you count?* (2)
- *So, if we started on 5, jumped back 2, and landed on 3 – what does this tell us?* (5 take away 2 is 3.)
- Ask learners to put their finger on the number 10.
- Ask learners to jump backwards to 7, counting the jumps as they go. (1, 2, 3 jumps.)
- *How many jumps did you count?* (3)
- *So, if we started on 10, jumped back 3, and landed on 7 – what does this tell us?* (10 take away 3 is 7.)
- Repeat with other numbers.

Activity 2: Learners work in groups

Give each group of learners fifteen counters.

- Write $\boxed{-5}$ on the board.
- Explain to the class that they are now going to take 5 away from different numbers, using their counters.
- Put 15 counters in the middle of the desk. Now take 5 counters away from 15 counters. Ask: *What did you find?*
- Ask learners to give you the number sentence that says what they did: $(15 - 5 = 10)$.
- Put 15 counters in the middle of the desk. Now take 5 counters away from 9 counters. Ask: *What did you find?*
- Ask learners to give you the number sentence that says what they did: $(9 - 5 = 4)$.
- Repeat with other numbers.
- Change the number on the board to $\boxed{-8}$ and repeat the above steps with a variety of numbers.
- The number on the board can be changed as many times as is needed.

Activity 3: Whole class activity

Draw the following spider diagram on the board. (These appear in the classwork activity.)

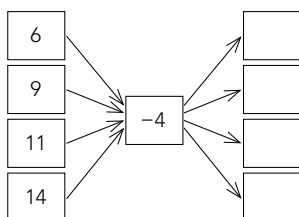

- Explain to learners that to complete this spider diagram, they use the number and operation from the middle box and apply it to each of the blocks on the left hand side. They write the answers on the right-hand side. The first one they do is $6 - 4 = 2$, then $9 - 4 = 5$, etc.

4. Classwork activity (25 minutes) (See next page)

5. Homework activity (5 minutes) (See next page)

6. Reflection on lesson

Term 3 Lesson 13: Subtraction – number lines and counting back

Classwork

1. Fill in the numbers on the number line and then write a number sentence for each.

Each number line starts at zero.

a)

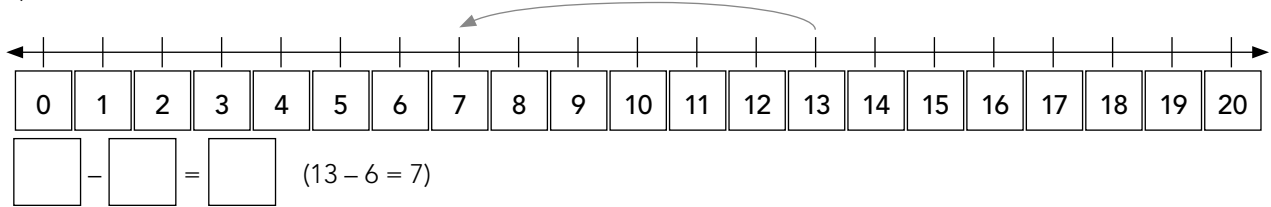

b)

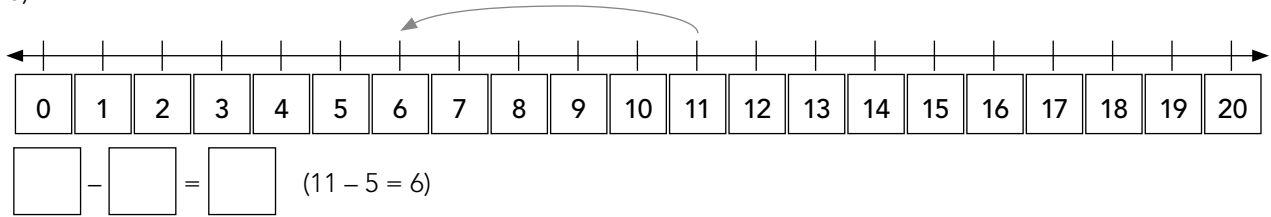

2. Complete the subtraction problems.

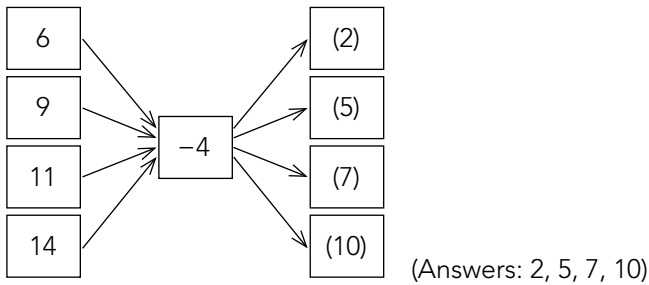

Homework

1. Complete the subtraction problems.

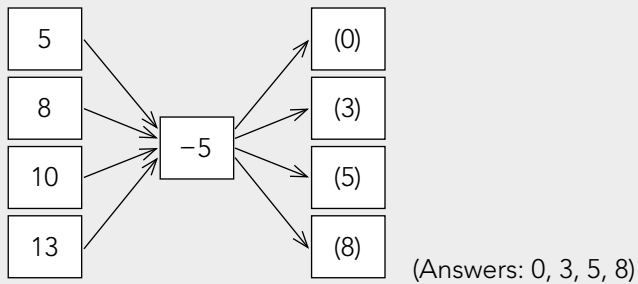

LESSON 14: SUBTRACTION – COUNTING BACK

Teacher's notes

CAPS topics: 1.1 Count objects, 1.2 Count forwards and backwards, 1.16 Mental mathematics, 1.6 Problem-solving techniques, 1.12 Techniques (methods or strategies) 1.13, 1.17 Addition and subtraction.

Lesson vocabulary: Subtract, number sentence, subtraction, take away, equals, backwards, forwards.

Prior knowledge: Learners should have been taught how to:

- Add and subtract up to 10 using concrete apparatus and pictures.
- Use bonds up to 10.
- Add using building up and breaking down of numbers as a technique.

Concepts:

- Solve problems in context and explain own solutions to problems involving subtraction with answers up to fifteen.
- Use techniques like concrete apparatus, drawing of pictures and building up and breaking down numbers.
- Use appropriate symbols (+, -, =, □).

Resources: Unifix blocks, counters, whiteboards/scrap paper.

DBE workbook activities relevant to this lesson:

- DBE Worksheet 73 (p. 18).

Assessment: Refer to the tracker for today's formal/informal oral, practical or written assessment activity.

Remediation: Give learners a word problem, e.g. *Khaya had 10 marbles. He lost 3 marbles. How many marbles did he have left?* Help learners to solve the word problem using counters. Ask learners to describe what they did with the counters. (We had 10 counters and we took 3 counters away.) Ask learners how many counters are left behind. (7 counters.) *What does that tell us?* (Khaya had 7 marbles left from the 10 marbles he started with). Help learners to write the number sentence ($10 - 3 = 7$). Repeat with other word problems.

Enrichment: See enrichment activity cards.

1. Mental maths

1.1 Counting (5 minutes)

- Count forwards and backwards in 5s between 0 and 70, e.g. 25, 30, 35 ...

1.2 Recall and strategies (10 minutes)

	Which number is 1 less than:	Answer
1.	9	8
2.	15	14
3.	7	6
4.	14	13
5.	8	7

	Which number is 1 less than:	Answer
6.	13	12
7.	11	10
8.	7	6
9.	10	9
10.	4	3

2. Correction/reflection on homework (15 minutes)

Reflection/remediation based on previous day's work/homework.

3. Lesson content – concept development (30 minutes)

Activity 1: Learners work in groups

- Give each group of learners ten counters.
- Ask them to take away four counters..
E.g. ●●●●●●●●~~●~~~~●~~~~●~~~~●~~
- *What can you tell me about what you did with your counters? (10 take away 4 is 6.)*
- *We can write it like this: $10 - 4 = 6$.*
- Ask learners to put the 10 counters back in one pile.
- Ask learners to take away 1 counter.
E.g. ●●●●●●●●●●~~●~~
- *What can you tell me about your counters? (10 take away 1 is 9.)*
- *We can write it like this: $10 - 1 = 9$.*
- Repeat with other examples like this using the 10 counters.

Activity 2: Learners work in groups

Give each group of learners fifteen Unifix blocks, whiteboards/scrap paper.

- Ask the learners to place their 15 Unifix on their tables:
E.g. 
- Ask learners to take away 2 Unifix blocks.
- Ask learners to explain in words what they have just done with the Unifix blocks: (15 take away 2 is 13).
- Ask the learners to write this as a number sentence ($15 - 2 = 13$).
- Ask the learners to find all the other subtraction problems with regards to the number 15.
 $15 - 0 = 15$; $15 - 1 = 14$; $15 - 3 = 12$; $15 - 4 = 11$; $15 - 5 = 10$; $15 - 6 = 9$; $15 - 7 = 8$; $15 - 8 = 7$; $15 - 9 = 6$;
 $15 - 10 = 5$; $15 - 11 = 4$; $15 - 12 = 3$; $15 - 13 = 2$; $15 - 14 = 1$; $15 - 15 = 0$
These do not need to be found in this order.
- Work through many similar examples.
- Such as: 2 and 13; 3 and 12; 4 and 11; 5 and 10; 6 and 9; 7 and 8; 8 and 7; 9 and 6; 10 and 5; 11 and 4; 12 and 3; 13 and 2; 14 and 1.
- Depending on available time, similar activities can be done with the numbers 11, 12, 13, and 14.

Activity 3: Learners work individually

Leave the Unifix blocks on the table for learners to use when they find the solution to the following word problem.

- Give the learners a word problem:
Lindo had 11 sweets. He gave 5 to his friend. How many sweets did Lindo have left?
- Ask learners to solve the problem using their Unifix blocks (or a drawing, or a number sentence).

- Ask learners to write the number sentence ($11 - 5 = 6$).
- Repeat with other examples.

4. Classwork activity (25 minutes) (See next page)

5. Homework activity (5 minutes) (See next page)

6. Reflection on lesson



Term 3 Lesson 14: Subtraction – counting back

Classwork

1. Write the number sentences.



- a) ● ● ● ● ● ~~●~~ ~~●~~ (7 – 2 = 5)
- b) ● ● ● ● ● ~~●~~ ~~●~~ ~~●~~ ~~●~~ ~~●~~ (9 – 5 = 4)
- c) ● ● ● ~~●~~ ~~●~~ ~~●~~ ~~●~~ ~~●~~ ~~●~~ (10 – 7 = 3)
- d) ● ● ● ● ● ● ● ~~●~~ ~~●~~ ~~●~~ ~~●~~ ~~●~~ ~~●~~ ~~●~~ (13 – 8 = 5)
- e) ● ● ● ● ● ● ● ● ● ~~●~~ ~~●~~ ~~●~~ ~~●~~ ~~●~~ ~~●~~ ~~●~~ (15 – 7 = 8)

2. Draw a picture and write a number sentence:

- a) Thabo had 7 books. He gave 4 to Lebo. How many books did Thabo have left?
( 7 – 4 = 3)
- b) Mark had 10 sweets. He ate 2 sweets. How many sweets did Mark have left?
( 10 – 2 = 8)
- c) Emily picked 15 flowers. On her way home, she dropped 6 flowers. How many flowers did she have left?
( 15 – 6 = 9)

Homework

1. Draw a picture and write a number sentence:

- a) You have 11 balls. You lose 6 balls. How many balls do you have left?
( 11 – 6 = 5)
- b) You have 8 pencils. You give 3 to a friend. How many pencils do you have left?
( 8 – 3 = 5)

LESSON 15: ADDITION AND SUBTRACTION

Teacher's notes

CAPS topics: 1.1 Count objects, 1.2 Count forwards and backwards, 1.16 Mental mathematics, 1.6 Problem-solving techniques, 1.12 Techniques (methods or strategies) 1.13, 1.17 Addition and subtraction.

Lesson vocabulary: Subtract, add, plus, more, altogether, count on, number sentence, addition, subtraction, take away, equals.

Prior knowledge: Learners should have been taught how to:

- Add and subtract up to 10 using concrete apparatus and pictures.
- Use bonds up to 10.
- Add using building up and breaking down of numbers as a technique.

Concepts:

- Solve problems in context and explain own solutions to problems involving addition and subtraction with answers up to fifteen.
- Use techniques like concrete apparatus, drawing of pictures and building up and breaking down numbers.
- Use appropriate symbols (+, -, =, □).

Resources: Counters, whiteboards/scrap paper.

DBE workbook activities relevant to this lesson:

- DBE Worksheet 73 (pp. 19).

Assessment: Refer to the tracker for today's formal/informal oral, practical or written assessment activity.

Remediation: Ask learners to put 15 counters in front of them. Ask learners to take 8 counters away. *How many counters do you have left?* (7 counters.) Ask learners to write the number sentence. ($15 - 8 = 7$) Ask learners to put 3 counters back into their pile in front of them. *How many counters are there in total now?* (10 counters.) Ask learners to write the number sentence. ($7 + 3 = 10$) Help learners to write the number sentence for both steps together. ($15 - 8 + 3 = 10$) Repeat with other numbers.

Enrichment: See enrichment activity cards.

1. Mental maths

1.1 Counting (5 minutes)

- Count forwards and backwards in 10s between 0 and 70, e.g. 20, 30, 40 ...

1.2 Recall and strategies (10 minutes)

	Add the following:	Answer
1.	$__ + 2 = 4$	2
2.	$__ + 1 = 5$	4
3.	$__ + 2 = 3$	1
4.	$__ + 3 = 5$	2
5.	$__ + 3 = 4$	1

	Add the following:	Answer
6.	$__ + 4 = 4$	0
7.	$__ + 0 = 3$	3
8.	$__ + 2 = 5$	3
9.	$__ + 1 = 3$	2
10.	$__ + 0 = 5$	5

2. Correction/reflection on homework (15 minutes)

Reflection/remediation based on previous day's work/homework.

3. Lesson content – concept development (30 minutes)

Activity 1: Learners work in groups

Give each group of learners 15 counters and whiteboards/scrap paper.

- Ask learners to put 10 counters in front of them.
- Ask learners to arrange the counters to show what they know about the number 10.
- *What can you tell me about the number 10?* (Learners could suggest any of the number facts related to the number 10, e.g. $8 + 2 = 10$; $10 - 6 = 4$; $3 + 3 + 4 = 10$; etc.)
- Write the number sentences on the board as they are suggested by the learners.
- Ask learners to put 15 counters in front of them.
- Ask learners to arrange the counters to show what they know about the number 15.
- Ask learners to write all the number sentences they can come up with on their whiteboards/scrap paper. (Again, many examples could be suggested by learners, e.g. $15 - 5 = 10$; $13 + 2 = 15$, etc.)
- Ask learners to draw pictures to match their number sentences.
- Remind them to use both addition and subtraction problems.

Activity 2: Learners work in groups

Learners continue to work with the 15 counters from Activity 1.

- Put all 15 counters in the middle of the desk. Take 10 counters away.
- *How many counters do you have left?* (5 counters.)
- Ask learners to write the number sentence on their whiteboards/scrap paper ($15 - 10 = 5$).
- Ask learners to put 6 counters back into their pile in front of them.
- *How many counters are there in total now?* (11 counters.)
- Ask learners to write the number sentence on their whiteboards/scrap paper ($5 + 6 = 11$).
- Ask learners to describe what they did with their counters. (We started with 15 counters, then we took away 10, then we put 6 back.)
- *So we can write that as $15 - 10 + 6$.*
- *How many counters were we left with?* (11 counters.)
- *What would the number sentence look like then?* ($15 - 10 + 6 = 11$)
- Ask learners to write this number sentence on their whiteboards/scrap paper.
- Repeat with other numbers.

4. Classwork activity (25 minutes) (See next page)

5. Homework activity (5 minutes) (See next page)

6. Reflection on lesson

Term 3 Lesson 15: Addition and subtraction

Classwork

1. Draw a picture and complete the number sentences:

- a) $5 + 7 = \square$ (●●●●● ●●●●●●●● 12)
b) $8 + 3 = \square$ (●●●●●●●● ●●● 11)
c) $9 + 6 = \square$ (●●●●●●●●● ●●●●●●●●● 15)
d) $14 - 4 = \square$ (●●●●●●●●●●●●●● ~~●●●●~~ 10)
e) $12 - 9 = \square$ (●●●● ~~●●●●●●●●●●~~ 3)
f) $10 - 10 = \square$ (~~●●●●●●●●●●~~ 0)

2. Calculate the following:

- a) $15 - 4 + 1 = \square$ (12)
b) $13 - 5 + 2 = \square$ (10)
c) $11 - 6 + 4 = \square$ (9)
d) $9 - 7 + 5 = \square$ (7)

Homework

1. Calculate the following:

- a) $14 - 2 + 3 = \square$ (15)
b) $10 - 4 + 2 = \square$ (8)
c) $8 - 7 + 9 = \square$ (10)

LESSON 16: DOUBLES

Teacher's notes

CAPS topics: 1.1 Count objects, 1.2 Count forwards and backwards, 1.16 Mental mathematics, 1.6 Problem-solving techniques, 1.13 Addition and subtraction.

Lesson vocabulary: How many, double, halve, half, the same, plus, equals, symbols.

Prior knowledge: Learners should have been taught how to:

- Do addition using doubling (1–10).

Concepts:

- Solve problems using concrete apparatus and pictures and explain solutions to problems involving addition with answers up to fifteen.
- Use appropriate symbols (+, -, =).
- Use doubling as a technique when solving problems.

Resources: Pictures of items that children can use to double (tricycles, dogs, egg boxes), counters.

DBE workbook activities relevant to this lesson:

- DBE Worksheet 85 (p. 43).

Assessment: Refer to the tracker for today's formal/informal oral, practical or written assessment activity.

Remediation: Give each learner 15 counters. *Show me 1 counter. Double it. Show me 2 counters. Double them.* Continue the same activity with 3, 4, 5, 6, and 7 counters.

Enrichment: See enrichment activity cards.

1. Mental maths

1.1 Counting (5 minutes)

- Count forwards and backwards in 5s between 0 and 70, e.g. 45, 50, 55 ...

1.2 Recall and strategies (10 minutes)

	Subtract the following:	Answer
1.	$5 - 2 = \underline{\quad}$	3
2.	$4 - 3 = \underline{\quad}$	1
3.	$3 - 1 = \underline{\quad}$	2
4.	$4 - 4 = \underline{\quad}$	0
5.	$5 - 0 = \underline{\quad}$	5

	Subtract the following:	Answer
6.	$4 - 1 = \underline{\quad}$	3
7.	$3 - 0 = \underline{\quad}$	3
8.	$4 - 2 = \underline{\quad}$	2
9.	$5 - 1 = \underline{\quad}$	4
10.	$2 - 2 = \underline{\quad}$	0

2. Correction/reflection on homework (15 minutes)

Reflection/remediation based on previous day's work/homework.

3. Lesson content – concept development (30 minutes)

Note that for this lesson when you prepare you need to collect pictures to use in Activity 1. If you have not collected the pictures you need to draw simple pictures on the board instead.

Activity 1: Whole class activity

Use your prepared pictures for this activity.

- Call up two learners to stand in the front of the class. Ask: *How many eyes are there?* (4)
- *How did you get your answer?* (We added 2 and 2 which makes 4.)
- *We say double 2 is 4.*
- Ask one learner to hold up his/her two hands. Ask: *How many fingers are there?* (10)
- *How did you get your answer?* (We added 5 and 5 which makes 10.)
- *We say double 5 is 10.*
- Show the learners a picture of two tricycles. Ask: *How many wheels are there?* (6)
- *How did you get your answer?* (We added 3 and 3 which makes 6.)
- *We say double 3 is 6.*
- Show a picture of two dogs. Ask: *How many legs are there?* (8)
- *How did you get your answer?* (We added 4 and 4 which makes 8.)
- *We say double 4 is 8.*
- Show a picture of two egg boxes with 6 eggs in each. Ask: *How many eggs are there?* (12)
- *How did you get your answer?* (We added 6 and 6 which makes 12.)
- *We say double 6 is 12.*
- Show a picture of two weeks from the class calendar. Ask: *How many days are there?* (14)
- *How did you get your answer?* (We added 7 and 7 which makes 14.)
- *We say double 7 is 14.*

Activity 2: Learners work in groups

Give each group of learners 15 counters, and ask them the following:

- *What is _____?* (Let them use counters if necessary, but they can simply give the number sentences when they can do the doubles mentally, especially for the smaller numbers, like 2 and 3.)
 - *What is double 1?* (2)
 - *What is double 2?* (4)
 - *What is double 3?* (6)
 - *What is double 4?* (8)
 - *What is double 5?* (10)
 - *What is double 6?* (12)
 - *What is double 7?* (14)

4. Classwork activity (25 minutes) (See next page)

5. Homework activity (5 minutes) (See next page)

6. Reflection on lesson

Term 3 Lesson 16: Doubles

Classwork

1. Answer the following. Draw more counters to help you.

- a) Double ●●● is (●●● ●●● 6)
b) Double ●●●●● is (●●●●● ●●●●● 10)
c) Double ●● is (●● ●● 4)
d) Double ●●●● is (●●●●●●●● 8)
e) Double ● (● ● 2)
f) Double ●●●●●●● is (●●●●●●● ●●●●●●● 12)

2. Write down the doubles. The first one is done for you.

- a) 2 is double 1 or $1 + 1$
b) 8 is (double 4 or $4 + 4$)
c) 4 is (double 2 or $2 + 2$)
d) 10 is (double 5 or $5 + 5$)
e) 6 is (double 3 or $3 + 3$)
f) 12 is (double 6 or $6 + 6$)
g) 14 is (double 7 or $7 + 7$)

Homework

1. Answer the following:

- a) Double 7 is (14)
b) Double 10 is (20)
c) Double 3 is (6)

2. Write down the doubles.

- a) 12 is (double 6 or $6 + 6$)
b) 8 is (double 4 or $4 + 4$)
c) 4 is (double 2 or $2 + 2$)

WEEK 5

LESSON 17: DOUBLES

Teacher's notes

CAPS topics: 1.1 Count objects, 1.2 Count forwards and backwards, 1.16 Mental mathematics, 1.6 Problem-solving techniques, 1.13 Addition and subtraction.

Lesson vocabulary: How many, double, halve, half, the same, plus, equals, symbols.

Prior knowledge: Learners should have been taught how to:

- Do addition using doubling (1–10).

Concepts:

- Solve problems using concrete apparatus and pictures and explain solutions to problems involving addition with answers up to fifteen.
- Use appropriate symbols (+, -, =).
- Use doubling as a technique when solving problems.

Resources: Unifix blocks, whiteboards/scrap paper.

DBE workbook activities relevant to this lesson:

- DBE Worksheet 85 (p. 42).

Assessment: Refer to the tracker for today's formal/informal oral, practical or written assessment activity.

Remediation: Give each learner 15 Unifix blocks. *Show me 1 Unifix block. Double it. (Explain what it means to double if necessary.) How many Unifix blocks do you have? (2) Add one more Unifix block. How many Unifix blocks to you have now? (5) Show me 2 Unifix blocks. Double it. Continue the same activity with 3, 4, 5, 6, and 7 Unifix blocks, adding 1 extra block each time.*

Enrichment: See enrichment activity cards.

1. Mental maths

1.1 Counting (5 minutes)

- Count forwards and backwards in 2s between 0 and 70, e.g. 56, 58, 60 ...

1.2 Recall and strategies (10 minutes)

	Which number is bigger?	Answer
1.	9 or 12	12
2.	5 or 15	15
3.	1 or 4	4
4.	14 or 0	14
5.	7 or 6	7

	Which number is bigger?	Answer
6.	3 or 11	11
7.	2 or 7	7
8.	10 or 13	13
9.	0 or 3	3
10.	6 or 12	12

2. Correction/reflection on homework (15 minutes)

Reflection/remediation based on previous day's work/homework.

3. Lesson content – concept development (30 minutes)

Activity 1: Learners work in groups

Give learners whiteboards/scrap paper.

- Ask learners to draw 3 circles. (● ● ●)
- Ask learners to double their number. (● ● ● ● ● ●)
- *What do you notice about what you drew? (We drew 2 groups of 3; both groups are exactly the same.)*
- *If I add the two groups – what do I get? Write the number sentence like this $3 + 3 = 6$.*
- Repeat with other numbers.



Activity 2: Learners work in groups

Give each group of learners 15 Unifix blocks.

- *Use your Unifix blocks to show me double 2.* (Learners put out two groups of 2 Unifix blocks.)
- *Write a number sentence to show what you have found using the Unifix.* ($2 + 2 = 4$ Unifix blocks.)
- *Use your Unifix blocks to show me double 5.* (Learners put out two groups of 5 Unifix blocks.)
- *Write a number sentence to show what you have found using the Unifix.* ($5 + 5 = 10$ Unifix blocks.)
- Repeat with other examples.
- Always show the full correct number sentences to record what you have done with the blocks.

Activity 3: Learners work in groups

Learners continue working with the 15 Unifix blocks from Activity 2.

- *How can you make 6 using what you know about doubles?* (Learners put out two groups of 3 Unifix blocks.
)
- *Show me the number sentence.* ($3 + 3 = 6$)
- *How can you make 8 using what you know about doubles?* (Learners put out two groups of 4 Unifix blocks, with one 1 extra Unifix block )
- *Show me the number sentence.* ($4 + 4 + 1 = 9$)
- Repeat with other examples.

4. Classwork activity (25 minutes) (See next page)

5. Homework activity (5 minutes) (See next page)

6. Reflection on lesson

Term 3 Lesson 17: Doubles

Classwork

- Answer the following. Draw counters to help you.
 - Double 2 is (●● ●● 4)
 - Double 5 is (●●●●● ●●●●● 10)
 - Double 3 is (●●● ●●● 6)
 - Double 6 is (●●●●●● ●●●●●● 12)
 - Double 4 is (●●●● ●●●● 8)
 - Double 7 is (●●●●●●● ●●●●●●● 14)
- Complete the following. The first one is done for you:
 - $2 + 2 = 4$ or double 2 = 4
 - $3 + 3 =$ (6 or double 3 = 6)
 - $4 + 4 =$ (8 or double 4 = 8)
 - $5 + 5 =$ (10 or double 5 = 10)
 - $6 + 6 =$ (12 or double 6 = 12)
 - $7 + 7 =$ (14 or double 7 = 14)

Homework

- Draw 5 counters. Double it. Write the doubling sum.
(●●●●● ●●●●● $5 + 5 = 10$)
- Draw 7 counters. Double it. Write the doubling sum.
(●●●●●●● ●●●●●●● $7 + 7 = 14$)

LESSON 18: HALVES

Teacher's notes

CAPS topics: 1.1 Count objects, 1.2 Count forwards and backwards, 1.16 Mental mathematics, 1.6 Problem-solving techniques, 1.13 Addition and subtraction.

Lesson vocabulary: How many, halve, half, the same.

Prior knowledge: Learners should have been taught how to:

- Do addition using doubling (1–10).

Concepts:

- Solve problems using concrete apparatus and pictures and explain solutions to problems.
- Use halving as a technique when solving problems.

Resources: Pictures (see Lesson 16), counters.

DBE workbook activities relevant to this lesson:

- DBE Worksheet 86 (p. 44).

Assessment: Refer to the tracker for today's formal/informal oral, practical or written assessment activity.

Remediation: Give each learner 14 counters. *Show me 4 counters. Halve them. Tell me what you did. (We made two groups of 2 counters.) So, what is half of 4? (2) Show me 6 counters. Halve them.* Continue the same activity with 8, 10, 12, 14, and 2 counters.

Enrichment: See enrichment activity cards.

1. Mental maths

1.1 Counting (5 minutes)

- Count forwards and backwards in 10s between 0 and 70, e.g. 70, 60, 50 ...

1.2 Recall and strategies (10 minutes)

	What is?	Answer
1.	$2 + 3 = ?$	5
2.	$3 + 1 = ?$	4
3.	$5 + 4 = ?$	9
4.	$2 + 2 = ?$	4
5.	$6 + 3 = ?$	9

	What is?	Answer
6.	$7 - 4 = ?$	3
7.	$9 - 1 = ?$	8
8.	$8 - 3 = ?$	5
9.	$10 - 2 = ?$	8
10.	$6 - 3 = ?$	3

2. Correction/reflection on homework (15 minutes)

Reflection/remediation based on previous day's work/homework.

3. Lesson content – concept development (30 minutes)

Note that for this lesson you can use the same pictures that you collected and used in Activity 1 of Lesson 16. If you do not have pictures you need to draw simple pictures on the board instead.

Activity 1: Whole class activity

Use your prepared pictures for this activity.

- Call up two learners to stand in the front of the class. Ask: *How many ears are there?* (4 ears.)
- *Halve the number of ears. How many ears are in each group?* (2 ears.)
- *We say half of 4 is 2.*
- Ask one learner to hold up his/her two hands. Ask: *How many fingers are there?* (10 fingers.)
- *Halve the number of fingers. How many fingers are in each group?* (5 fingers.)
- *We say half of 10 is 5.*
- Show the learners a picture of two tricycles. Ask: *How many wheels are there?* (6 wheels.)
- *Halve the number of wheels. How many wheels are in each group?* (3 wheels.)
- *We say half of 6 is 3.*
- Show a picture of two dogs. Ask: *How many legs are there?* (8 legs.)
- *Halve the number of legs. How many legs are in each group?* (4 legs.)
- *We say half of 8 is 4.*
- Show a picture of two egg boxes with 6 eggs in each. Ask: *How many eggs are there?* (12 eggs.)
- *Halve the number of eggs. How many eggs are in each group?* (6 eggs.)
- *We say half of 12 is 6.*
- Show a picture of two weeks from the class calendar. Ask: *How many days are there?* (14 days.)
- *Halve the number of days. How many days are in each group?* (7 days.)
- *We say half of 14 is 7.*

Activity 2: Learners work in groups

- Give each group of learners 15 counters, and ask them the following:
- *What is _____?* (Learners should use counters if necessary)
 - *half of 2?* (1)
 - *half of 4?* (2)
 - *half of 6?* (3)
 - *half of 8?* (4)
 - *half of 10?* (5)
 - *half of 12?* (6)
 - *half of 14?* (7)

4. Classwork activity (25 minutes) (See next page)

5. Homework activity (5 minutes) (See next page)

6. Reflection on lesson

Term 3 Lesson 18: Halves

Classwork

1. Answer the following:

- a) 

There are stars. Half of the stars is (5)

- b) 

There are pencils. Half of the pencils is (3)

- c) 

There are flowers. Half of the flowers is (4)

- d) 

There are faces. Half of the faces is (6)

- e) 

There are hands. Half of the hands is (2)

- f) 

There are hearts. Half of the hearts is (1)

2. Answer the following. Draw counters to help you.

- a) Half of 4 is (●● ●● 2)

- b) Half of 6 is (●●● ●●● 3)

- c) Half of 8 is (●●●● ●●●● 4)

- d) Half of 2 is (● ● 1)

- e) Half of 14 is (●●●●●●●● ●●●●●●●● 7)

- f) Half of 10 is (●●●●●● ●●●●●● 5)

Homework

1. Answer the following:

- a) 

There are people. Half of the people is (3)

- b) 

There are bicycles. Half of the bicycles is (7)

- c) 

There are books. Half of the books is (2)

LESSON 19: HALVES AND DOUBLES

Teacher's notes

CAPS topics: 1.1 Count objects, 1.2 Count forwards and backwards, 1.16 Mental mathematics, 1.6 Problem-solving techniques, 1.13 Addition and subtraction.

Lesson vocabulary: How many, halve, half, double, doubles, doubling.

Prior knowledge: Learners should have been taught how to:

- Do addition using doubling (1–10).

Concepts:

- Solve problems using concrete apparatus and pictures and explain solutions to problems.
- Use halving as a technique when solving problems.

Resources: Counters.

DBE workbook activities relevant to this lesson:

- DBE Worksheet 86 (p. 45).

Assessment: Refer to the tracker for today's formal/informal oral, practical or written assessment activity.

Remediation: Give each learner 14 counters. *Show me 4 counters. Half of what number is 4? (8) Tell me what you did? (We made two groups of 4 counters which is 8 counters.) So, what do you know about 8? (Half of 8 is 4, and double 4 is 8.)* Continue the same activity with 6, 8, 10, 12, 14, and 2 counters.

Enrichment: See enrichment activity cards.

1. Mental maths

1.1 Counting (5 minutes)

- Count forwards and backwards in 2s between 0 and 70, e.g. 18, 20, 22 ...

1.2 Recall and strategies (10 minutes)

	What is double:	Answer
1.	5	10
2.	7	14
3.	4	8
4.	6	12
5.	3	6

	What is half of:	Answer
6.	8	4
7.	10	5
8.	12	6
9.	14	7
10.	6	3

2. Correction/reflection on homework (15 minutes)

Reflection/remediation based on previous day's work/homework.

3. Lesson content – concept development (30 minutes)

This is the last of four lessons about double and halves. In this lesson the connection between doubling and halving is made clear. This is an important numeric relationship – so you should make sure that learners all talk about what they are doing and use the correct mathematical language while they do this.

Activity 1: Learners to work in groups

Give each group of learners 14 counters.

- Put 10 counters in front of you.
- Halve the 10 counters.
- What can you tell me about what you did? (We spilt the 10 counters into 2 groups of 5.)
- So half of 10 is ...? (5)
- Repeat with other numbers.
- Encourage different members of the groups to work with the counters in turns, so that one learner does not dominate the group.
- In this lesson halving is consolidated.

Activity 2: Learners to work in groups

Learners continue to work with counters if necessary.

In this activity the relationship between doubling and halving is established.

- If we double 1, how many counters will we have? (2)
- So, half of 2 is ...? (1)
- Ask learners to write:

Double 1 is 2	Half of 2 is 1
---------------	----------------

- If we double 2, how many counters will we have? (4)
- So, half of 4 is ...? (2)
- Ask learners to write:

Double 2 is 4	Half of 4 is 2
---------------	----------------

- Repeat with other numbers.

Activity 3: Learners to work in groups

Learners continue to work with counters if necessary.

In this activity the relationship between doubling and halving is consolidated.

- Half of what number is 6? (12)
- How did you know this? (6 doubled is 12, so half of 12 is 6.)
- Half of what number is 4? (8)
- How did you know this? (4 doubled is 8, so half of 8 is 4.)
- Repeat with other numbers.

4. Classwork activity (25 minutes) (See next page)

5. Homework activity (5 minutes) (See next page)

6. Reflection on lesson

Term 3 Lesson 19: Halves and doubles

This classwork and homework contains halving activities. While learners do these activities you should ask them to discuss with a partner how the halves are related to doubles (in particular which doubles). This is to consolidate their understanding of the relationship between doubling and halving.

Classwork

1. Answer the following. Draw counters to help you.

a) Half of ●●●● is

(●● ~~●●~~ 2. Half of 4 is 2 because double 2 is 4.)

b) Half of ●●●●●● is

(●●● ~~●●●~~ 3. Half of 6 is 3 because double 3 is 6.)

c) Half of ●●●●●●●● is

(●●●●●● ~~●●●●●●~~ 5. Half of 10 is 5 because double 5 is 10.)

d) Half of ●●●●●●●● is

(●●●●●● ~~●●●●●●~~ 4. Half of 8 is 4 because double 4 is eight.)

e) Half of ●●●●●●●●●● is

(●●●●●●●● ~~●●●●●●●●~~ 6. Half of 12 is 6 because double 6 is 12.)

f) Half of ●●●●●●●●●●●● is

(●●●●●●●●●● ~~●●●●●●●●●●~~ 7. Half of 14 is 7 because double 7 is 14.)

2. Solve the following. The first one is done for you.

a) Half of 2 is 1

b) Half of is 5 (10)

c) Half of is 2 (4)

d) Half of is 3 (6)

e) Half of is 6 (12)

f) Half of is 4 (8)

g) Half of is 7 (14)

Homework

1. Solve the following.

a) Half of is 3 (6)

b) Half of is 6 (12)

c) Half of is 1 (2)

d) Half of is 7 (14)

LESSON 20: MASS

Teacher's notes

CAPS topics: 1.2 Count forwards and backwards, 1.16 Mental mathematics, 4.3 Mass.

Lesson vocabulary: Mass, heavy, light, heavier, lighter, heaviest, lightest, balance, estimate, measure, compare, record, balance scale.

Prior knowledge: Learners should have been taught how to:

- Estimate, measure, compare, order and record mass using a balancing scale and non-standard measures.
- Use words such as heavy, light, heavier and lighter when comparing objects.

Concepts:

- Estimate, measure, compare, order and record mass using a balancing scale and non-standard measures, e.g. blocks, bricks, etc.
- Use language to talk about the comparison, e.g. light, heavy, lighter, heavier.

Resources: Balance scale (make your own one using a coat hanger, string and two plastic yoghurt tubs if necessary), objects found in the classroom to use to compare mass.

DBE workbook activities relevant to this lesson:

- N/A

Assessment: Refer to the tracker for today's formal/informal oral, practical or written assessment activity.

Remediation: Give one learner two objects to hold, one in each hand. Ask: *Which object is heavier? Which object is lighter? Place it on the scale to check. Were you correct?* Do this a few times with different objects.

Enrichment: See enrichment activity cards.

1. Mental maths

1.1 Counting (5 minutes)

- Count forwards and backwards in 5s from any multiple between 0 and 80, e.g. 55, 60, 65 ...

1.2 Recall and strategies (10 minutes)

	What is 2 less than:	Answer
1.	10	8
2.	14	12
3.	9	7
4.	13	11
5.	15	13

	What is 2 more than:	Answer
6.	9	11
7.	11	13
8.	13	15
9.	8	10
10.	10	12

2. Correction/reflection on homework (15 minutes)

Reflection/remediation based on previous day's work/homework.

3. Lesson content – concept development (30 minutes)

This is the only lesson on the topic of mass this term. Learners need to consolidate their understanding of the concept and knowledge of the terminology related to the concept that they were introduced to earlier in the year. Look at the lesson vocabulary list (and *the Dictionary of Mathematical Terms*) to recap the terminology relevant to the lesson (e.g. balance scale and balance).

Activity 1: Learners work in groups

In this activity learners experiment with different familiar objects – talking about their mass and making comparisons using mathematical language.

- Ask the learners to lift a suitcase and a book – one in each hand.
- *What can you tell me about the suitcase and the book?* (The suitcase is heavier than the book/the book is lighter than the suitcase.)
- Ask the learners to replace the suitcase with a pencil.
- *What can you tell me about the book and the pencil?* (The book is heavier than the pencil/the pencil is lighter than the book.)
- *What can you tell me about the suitcase, the book and the pencil?* (The suitcase is light, the book is lighter and the pencil is the lightest/the suitcase is the heaviest, etc.)

Activity 2: Whole class activity

In this activity learners work with a scale balance to compare the masses of different items.

Place a balance scale on your table or allow a learner to hold your home-made scale by the handle. (A home-made scale can be made using a hanger, some string and two yoghurt tubs.)

- Place an object in each tub (use appropriate familiar objects that fit into the tubs).
- *Do the objects have the same mass or is one heavier?* (Answers will vary – discuss and explain the reasoning of how to compare masses – the heavier item hangs lower than the lighter item.)
- Ask the learners to find two objects that have the same mass by trying out a few objects in the scale.
- *Which two objects have the same mass?* (Answers will vary – any pair of objects that balance each other in the scale – which is when they hang at the same height – have the same mass.)
- Ask the learners to find two objects that have different masses by trying out a few objects in the scale.
- *Which object has a smaller/greater mass?* (Answers will vary – the heavier objects always hang lower than the lighter objects.)

4. Classwork activity (25 minutes) (See next page)

5. Homework activity (5 minutes) (See next page)

6. Reflection on lesson

Term 3 Lesson 20: Mass

Classwork

1. Which object is heavier? Tick the correct answer.

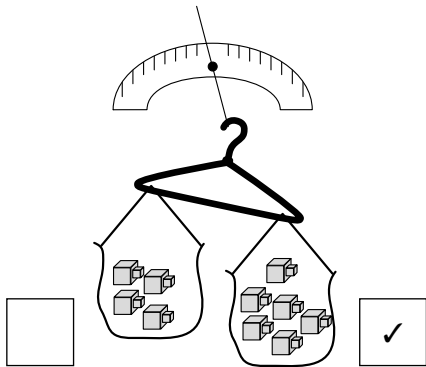

2. Which object is lighter? Tick the correct answer.

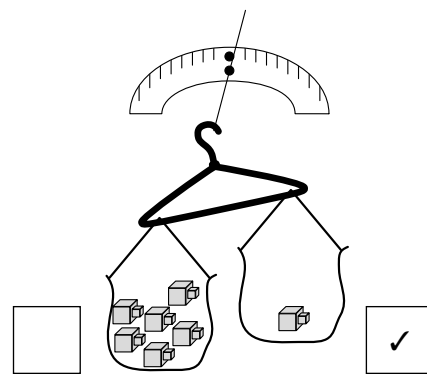

3. Which object is lighter? Tick the correct answer.

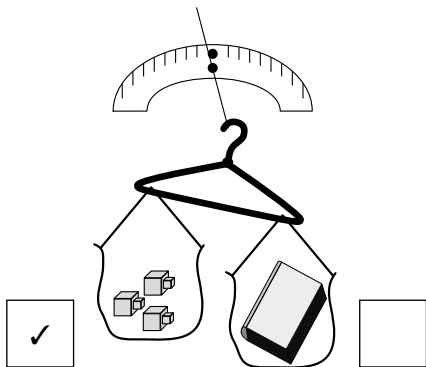

4. Which object is heavier? Tick the correct answer.

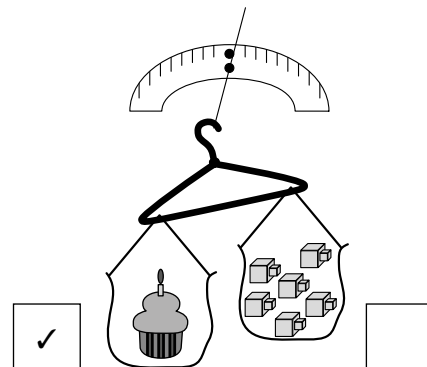

5. Draw counters that show the balance in these scales: (Answers will vary.)

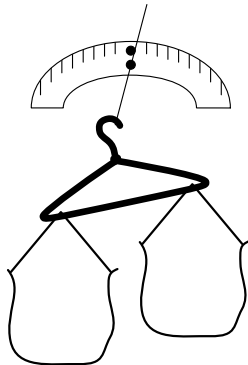

(Must show a heavier object in the lower tub.)

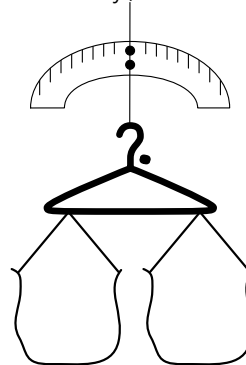

(Must show the same object in the two tubs – or objects that you know have equal masses.)

Homework

1. Draw a scale to show two items that have the same mass. (Answers will vary – but the scale must have balanced tubs.)
2. Draw a scale to show an item with a mass of 5 blocks. (Answers will vary – an object in the one tub shown balanced by 5 blocks in the other tub.)
3. Draw a scale to show two items with different masses. (Answers will vary – the two tubs of the scale are not balanced – one hangs lower than the other which shows that the objects do not have the same mass.)

WEEK 6

LESSON 21: DATA

Teacher's notes

CAPS topics: 1.2 Count forwards and backwards, 1.16 Mental mathematics, 5.4 Collect and organise data, 5.5 Represent data, 5.6 Analyse data.

Lesson vocabulary: Sort, collect, organise, describe, more, less, most, least, more common, least common, tally, data, pictograph.

Prior knowledge: Learners should have been taught how to:

- Collect and sort everyday objects.
- Draw a picture of the collected objects.
- Answer questions about how the collection was sorted and about the drawing of the collection.

Concepts:

- Collect and organise data about questions posed by the teacher.
- Represent data in a pictograph.

Resources: A full month's calendar (See *Printable Resources*), tally-table grid (see *Printable Resources*), weather pictograph (see *Printable Resources*).

DBE workbook activities relevant to this lesson:

- DBE Worksheet 78 (pp. 28 and 29).

Assessment: Refer to the tracker for today's formal/informal oral, practical or written assessment activity.

Remediation: Give the learners 3 'sunny cards', 2 'cloudy cards', 5 'rainy cards' and 1 'windy card'. Assist them to correctly sort the cards and then paste them in the correct columns on a blank pictograph. Ask questions like: *What kind of weather was more common? What kind of weather was least common? How many more sunny days than cloudy days were there?* etc.

Enrichment: See enrichment activity cards.

1. Mental maths

1.1 Counting (5 minutes)

- Count forwards and backwards in 5s from any number between 0 and 70.

1.2 Recall and strategies (10 minutes)

	Which numbers from 8 to 15 are less than:	Answer
1.	10	8, 9
2.	9	8
3.	11	8, 9, 10
4.	13	8, 9, 10, 11, 12
5.	12	8, 9, 10, 11

	Which numbers from 8 to 15 are more than:	Answer
6.	14	15
7.	10	11, 12, 13, 14, 15
8.	13	14, 15
9.	9	10, 11, 12, 13, 14, 15
10.	12	13, 14, 15

2. Correction/reflection on homework (15 minutes)

Reflection/remediation based on previous day's work/homework.

3. Lesson content – concept development (30 minutes)

This term there are two lessons on Data handling to consolidate learning of the Data handling concepts.

Activity 1: Learners work in groups































Give each group of learners a copy of the calendar showing weather conditions for January and a copy of the tally table. (If you can't make copies for learners then draw them on the board.)

- Ask the learners to count the number of sunny days (12).
- Ask them to count the sunny days and make a tally mark in the column next to the sun picture on the tally table grid.
- Count the total number of tally marks for the sunny days, and write it in the last column of the grid.
- Repeat the above steps for cloudy days, rainy days, partly cloudy days and windy days.
- For each weather type, learners mark up the tallies in the tally table and record the total number for each type after they have finished tallying.

Activity 2: Whole class activity

Discuss the data from the previous activity:

- How many sunny days were there last month? (12)
- How many windy days were there last month? (1)
- Ask other similar questions.
- Which type of weather did we have the most often in January? (Sunny.)
- Which type of weather did we have the least often in January? (Windy.)
- How many more sunny days than cloudy days did we have? etc. (11 more sunny days.)

January						
Sunday	Monday	Tuesday	Wednesday	Thursday	Friday	Saturday
		1 	2 	3 	4 	5 
6 	7 	8 	9 	10 	11 	12 
13 	14 	15 	16 	17 	18 	19 
20 	21 	22 	23 	24 	25 	26 
27 	28 	29 	30 	31 		

4. Classwork activity (25 minutes) (See next page)





5. Homework activity (5 minutes) (See next page)

6. Reflection on lesson

Term 3 Lesson 21: Data

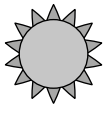
Classwork

1. Use the data from the January calendar to draw the pictograph.

Types of weather

2. Complete:

- There were __ sunny days in January. (12)
- There were __ windy days in January. (1)
- Most days in January were __. (sunny)
- How many more sunny days than rainy days were there? __ (1)
- I enjoy __ days.
- There were __ rainy days in January. (11)
- There were __ cloudy days in January. (3)
- Only one day in January was __. (windy)
- How many less windy days than rainy days were there? __ (10)
- I do not enjoy __ days. (Answers will vary.)

Homework

Number of shapes

1	★			
2	★		▲	
3	★		▲	
4	★		▲	■
5	★	●	▲	■
	★	●	▲	■

- How many squares are there? (2)
- How many stars are there? (5)
- How many more stars are there than squares? (3)
- How many less circles are there than triangles? (3)

LESSON 22: DATA

Teacher's notes

CAPS topics: 1.2 Count forwards and backwards, 1.16 Mental mathematics, 5.4 Collect and organise data, 5.5 Represent data, 5.6 Analyse data.

Lesson vocabulary: Collect, organise, data, sort, describe, more, less, most, least, more common, least common, pictograph.

Prior knowledge: Learners should have been taught how to:

- Collect and sort everyday objects.
- Draw a picture of the collected objects.
- Answer questions about how the collection was sorted and about the drawing of the collection.

Concepts:

- Collect and organise data about the class or school and answer questions posed by the teacher.
- Represent data in pictograph.
- Answer questions about data in pictograph.

Resources: Large blank pictograph (see *Printable Resources*).

DBE workbook activities relevant to this lesson:

- DBE Worksheet 79 (pp. 30, 31).

Assessment: Refer to the tracker for today's formal/informal oral, practical or written assessment activity.

Remediation: Ask learners to arrange themselves into groups according to their favourite colour. (Let them choose between red, blue, yellow and green.) Ask learners to count how many learners like each of the colours. Create a tally table with the learners, and compare the totals. Ask questions to get learners to compare the amounts, and to tell you what they know about everyone's favourite colours.

Enrichment: See enrichment activity cards.

1. Mental maths

1.1 Counting (5 minutes)

- Count forwards and backwards in 2s from any multiple between 0 and 70, e.g. 58, 56, 54 ...

1.2 Recall and strategies (10 minutes)

	Add the following:	Answer
1.	$1 + 1 + 2 =$	4
2.	$3 + 1 + 1 =$	5
3.	$2 + 2 + 0 =$	4
4.	$1 + 3 + 1 =$	5
5.	$2 + 2 + 1 =$	5

	Add the following:	Answer
	$2 + 1 + 2 =$	5
	$1 + 1 + 1 =$	3
	$2 + 1 + 0 =$	3
	$1 + 4 + 0 =$	5
	$1 + 1 + 3 =$	5

2. Correction/reflection on homework (15 minutes)

Reflection/remediation based on previous day's work/homework.

3. Lesson content – concept development (30 minutes)

In this lesson you gather data from the class. This shows learners the relevance of data handling to their lives. In the lesson activity you gather data about learners' birthdays over the whole year. In the classwork activity, learners work independently to draw a graph relating to birthdays in the first term, from data that is given to them.

Activity 1: Whole class activity

The learners will collect and sort data about the learners' birthdays.

- Ask for a show of hands for learners' birthdays in each month of the year.
- Record the tallies in a table on the board. The table should look like this: Record tallies under each month name and tally them up (find the totals) to write in the bottom row of the table.

Jan	Feb	March	April	May	June	July	Aug	Sep	Oct	Nov	Dec

Activity 2: Whole class activity

Discuss the data before moving on to the classwork activity. The answers to these questions must be based on the actual data you got by tallying the birthdays of the learners in the class.

- *How many children had birthdays in January? (Answers will vary.)*
- *How many children had birthdays in February? (Answers will vary.)*
- Ask similar questions with regards to other months.
- *Which month has the most number of birthdays? (Answers will vary.)*
- *Which month has the least number of birthdays? (Answers will vary.)*
- *How many children have birthdays in the first 6 months (first half) of the year? (Answers will vary.)*
- *How many children have birthdays in the last 6 months (second half) of the year? (Answers will vary.)*
- *How many more children have birthdays in the first/second half of the year than in the last/first half of the year? (Answers will vary.)*

4. Classwork activity (25 minutes) (See next page)

5. Homework activity (5 minutes) (See next page)

6. Reflection on lesson

Term 3 Lesson 22: Data

There is a printable version of a blank pictograph grid in the *Printable Resources* for learners to use in this lesson. You should give each learner a copy of it if you are able to make copies at school.

Classwork

Use this data for the activity.

These are the numbers of children who had birthdays during the first term:

January: 3

February: 6

March: 1

April: 3

1. Colour a block to represent each birthday.

Birthdays during the first term

7				
6				
5				
4				
3				
2				
1	January	February	March	April

Months

2. Look at the graph and then fill in:
 - a) How many children had birthdays in the first term? (13)
 - b) There were __ birthdays in April. (3)
 - c) There were __ birthdays in February. (6)
 - d) There was __ birthday in March. (1)
 - e) There were __ birthdays in January. (3)
 - f) The most number of birthdays were in __. (February)
 - g) The least number of birthdays were in __. (March)
 - h) Which months had the same number of birthdays? __ (January and April)

Homework

The ages of children in a class.

5				
4				
3				
2				
1				
	5 years	6 years	7 years	8 years

1. How many children are 5 years old? (1)
2. How many children are 8 years old? (2)
3. How many children are 6 years old? (5)
4. How many children are 7 years old? (4)
5. How many more 6 year olds are there than 5 year olds? (4)
6. How many less 8 year olds are there than 7 year olds? (2)

LESSON 23: MONEY AND CHANGE

Teacher's notes

CAPS topics: 1.2 Count forwards and backwards, 1.16 Mental mathematics, 1.11 Money, 1.6 Problem solving.

Lesson vocabulary: Money, currency, coins, cents, rands, how much, add, take away, equals.

Prior knowledge: Learners should have been taught how to:

- Recognise and identify the South African currency coins: 10c, 20c, 50c, R1, R2 and R5.
- Solve money problems involving totals and change to R10 and in cents up to 20c.

Concepts:

- Recognise and identify the South African currency coins: 10c, 20c, 50c, R1, R2, and R5.
- Solve money problems involving totals and change to R20 and in cents up to 20c.

Resources: Cut-out coins: 10c, 20c, 50c, R1, R2, R5, Cut-out notes: R10, R20 (see *Printable Resources*).

DBE workbook activities relevant to this lesson:

- DBE Worksheet 75 (pp. 22 and 23).

Assessment: Refer to the tracker for today's formal/informal oral, practical or written assessment activity.

Remediation: Give the learners the following coins and notes: R20, R10, R5, R2, R1. Ask the learners to use an abacus and add the following together: R2 and R2 and R1; R5 and R2; R1 and R5; etc. *How much do you have?* (R5; R7; R6)

Enrichment: See enrichment activity cards.

1. Mental maths

1.1 Counting (5 minutes)

- Count forwards and backwards in 2s between 0 and 60, e.g. 42, 44, 46 ...

1.2 Recall and strategies (10 minutes)

	Which number or numbers are between:	Answer
1.	9 and 12	10, 11
2.	12 and 15	13, 14
3.	11 and 14	12, 13
4.	7 and 9	8
5.	6 and 9	7, 8

	Which number or numbers are between:	Answer
6.	7 and 10	8, 9
7.	2 and 6	3, 4, 5
8.	8 and 11	9, 10
9.	10 and 13	11, 12
10.	13 and 15	14

2. Correction/reflection on homework (15 minutes)

Reflection/remediation based on previous day's work/homework.

3. Lesson content – concept development (30 minutes)

There are three lessons this term with a focus on money and problem solving. These lessons give learners the opportunity to consolidate their knowledge of the South African currency (notes and coins) as well as to work on problems solving involving operations, in the context of money problems. While learners work on the word problems involving money you should check that they do all understand the operation calculations they are doing and that they are becoming fluent in the procedures that they use to do these operations.

Activity 1: Learners work in groups

Give the learners a 20c coin, four 10c coins, three 50c coins, a R20 note and a R10 note, two R5 coins, two R2 coins and two R1 coins.

- Ask the learners to show you 20c from their pile of money.
- Is there only one correct answer? (No – two 10c coins; OR one 20c coin.)
- Ask the learners to show you R10 from their pile of money.
- *Is there only one correct answer?* (No – R5 and R5; R5, R2, R2 and R1; R10 note.)
- *Show me which coins and/or notes will make: R6, R8, R9, R12, R15, R20.*
- You should discuss all answers given by learners as there are a variety of possible correct answers.
- The learners will say: $R2 + R2 + R1 + R1 = R6$; $R5 + R2 + R1 = R8$; $R5 + R2 + R2 = R9$; $R10 + R2 = R12$; $R10 + R2 + R2 + R1 = R15$; $R10 + R5 + R5 = R20$.

Activity 2: Learners work in groups

- Ask the learners to put the following in front of them: 3 x 10c.
- *How much money do you have?* (30c)
- *If you spent 10c on sweets, how much money would you have left?* Ask them to show you how much money they have left. (20c)
- Ask the learners to put the following in front of them: R10, R5, R2, R1, R1.
- *How much money do you have?* (R19)
- *If you spent R15 on a book, how much money would you have left?* Ask them to show you how much money they have left. (R4)

Activity 3: Whole class activity

Write up a few sums involving money amounts (addition).

For example, calculate the following:

- $10c + 10c = \square$ (20c)
- $R5 + R5 = \square$ (R10)
- Do a few more examples if the learners need more practise before going on to the classwork activity.

4. Classwork activity (25 minutes) (See next page)

5. Homework activity (5 minutes) (See next page)

6. Reflection on lesson

Term 3 Lesson 23: Money and change

Note this activity does include a 50c coin. This is beyond the CAPS minimum requirements. Since the 5c is no longer used in SA, you could try this activity. Please leave out Question 1 if you think it is beyond your learners.

Classwork

1. Circle the coins that will make up 50c. (Answers will vary.)



2. Circle the coins that will make up R10. (Answers will vary.)



3. Calculate the following:

a) $10c + 10c + 10c = \square$ (30c)

b) $R5 + R10 = \square$ (R15)

c) $R10 + R10 = \square$ (R20)

d) $R5 + R7 + R1 + R2 = \square$ (R15)

4. Solve the following.

a) I have a 20c coin. My friend has three 10c coins. Who has the most money? (My friend has the most money – 30c.)

b) I have two R5 coins. My friend has a R1 and R5 coin. Who has the least money? (My friend has the least money – R6.)

Homework

1. Circle the coins that will make up R20. (Answers will vary.)



2. Calculate the following:

a) $10c + 10c = \square$ (20c)

b) $10c + 20c = \square$ (30c)

a) $R5 + R2 + R8 = \square$ (R15)

d) $R3 + R10 + R2 + R2 = \square$ (R17)

e) $R10 + R1 + R5 + R2 = \square$ (R18)

LESSON 24: MONEY AND CHANGE

Teacher's notes

CAPS topics: 1.2 Count forwards and backwards, 1.16 Mental mathematics, 1.11 Money, 1.6 Problem solving.

Lesson vocabulary: Money, currency, coins, cents, rands, how much, add, take away, equals.

Prior knowledge: Learners should have been taught how to:

- Recognise and identify the South African currency coins: 10c, 20c, 50c, R1, R2 and R5.
- Solve money problems involving totals and change to R10 and in cents up to 20c.

Concepts:

- Recognise and identify the South African currency coins – 10c, 20c, 50c, R1, R2, and R5.
- Solve money problems involving totals and change to R20 and in cents up to 20c.

Resources: Cut-out coins: 10c, 20c, 50c, R1, R2, R5, Cut-out notes: R10, R20 (see *Printable Resources*).

DBE workbook activities relevant to this lesson:

- DBE Worksheet 76 (pp. 24 and 25).

Assessment: Refer to the tracker for today's formal/informal oral, practical or written assessment activity.

Remediation: Give learners the following coins and notes: R20, R10, R5, R2, R1. Ask them to place a R10 and R5 in front of them on their desks. Then tell them that they must buy a chocolate for R5. Ask them to show how much money they have left. They take away the R5 and now they have R10 left. Ask learners to place a R10, R5, R2, R1, R1 and R1 on their desks. Ask them the following questions: *If I bought food for R15, how much money will be left? Show it with coins.* (R5)

Enrichment: See enrichment activity cards.

1. Mental maths

1.1 Counting (5 minutes)

- Count forwards and backwards in 10s from any number between 0 and 70.

1.2 Recall and strategies (10 minutes)

	Which numbers between 8 and 15 are less than:	Answer
1.	12	11, 10, 9, 8
2.	9	8
3.	13	12, 11, 10, 9, 8
4.	10	9, 8
5.	11	10, 9, 8

	Which numbers between 5 and 12 are more than:	Answer
6.	11	12
7.	8	9, 10, 11, 12
8.	7	8, 9, 10, 11, 12
9.	9	10, 11, 12
10.	6	7, 8, 9, 10, 11, 12

2. Correction/reflection on homework (15 minutes)

Reflection/remediation based on previous day's work/homework.

3. Lesson content – concept development (30 minutes)

Activity 1: Learners work in groups

Give the learners three 10c coins, two 20c coin, three 50c coins, a R20 note, a R10 note, two R5 coins, two R2 coins and four R1 coins.

- How much money is: $10c + 10c = ?$ (20c)
- How much money is: $10c + 20c = ?$ (30c)
- How much money is: $10c + 10c + 10c + 10c = ?$ (40c)
- How much money is: $20c + 20c = ?$ (40c)
- How much money is: $R10 + R2 + R2 + R1 = ?$ (R15)
- How much money is: $R5 + R5 + R2 + R1 = ?$ (R13)
- How much money is: $R10 + R5 + R2 = ?$ (R17)
- How much money is: $R5 + R5 + R2 + R2 + R1 + R1 = ?$ (R16)

Activity 2: Whole class activity

Give the learners word problems, and let them hold up their money to show the answers.

- *I go to the shop and I buy a ball for R4. I pay with R5. How much change will I get?*
(Encourage children to verbalise their method of $R5 - R4 = R1$.)
- *I go to the shop, and I buy sweets for R6. I pay with R10. How much change will I get?*
(Encourage children to verbalise their method of $R10 - R6 = R4$.)
- Repeat with other examples.

Activity 3: Learners work individually

Write up a few sums using money amounts (addition and subtraction).

For example, calculate the following:

- $10c - 10c = \square$ (0c)
- $R10 - R5 = \square$ (R5)
- Do a few more examples if the learners need more practise before going on to the classwork activity.

4. Classwork activity (25 minutes) (See next page)

5. Homework activity (5 minutes) (See next page)

6. Reflection on lesson

Term 3 Lesson 24: Money and change

Classwork

1. I have R15. I bought a bag of sweets for R11. Make a drawing to show how much money I have left.
(The two R2 coins are left.)



2. Fill in the correct answer:
- a) $20c - 10c = \square$ (10c)
 - b) $20c - 20c = \square$ (0c)
 - c) $R15 - R4 = \square$ (R11)
 - d) $R14 - R7 = \square$ (R7)
3. Calculate the following:
- a) $R20 - R2 - R8 = \square$ (R10)
 - b) $R5 - R4 = \square$ (R1)
 - c) $30c - 10c = \square$ (20c)
 - d) $R20 - R5 = \square$ (R15)
 - e) $R15 - R5 - R5 - R2 = \square$ (R3)

Homework

1. How much money?



2. Calculate the following:

- a) $40c - 10c = \square$ (30c)
- b) $R15 - R10 = \square$ (R5)
- c) $R10 - R1 - R1 - R2 = \square$ (R6)
- d) $20c - 10c - 10c = \square$ (0c)

WEEK 7

LESSON 25: MONEY – ADDITION AND SUBTRACTION

Teacher's notes

CAPS topics: 1.2 Count forwards and backwards, 1.16 Mental mathematics, 1.7, 1.13 Addition and subtraction, 1.11 Money.

Lesson vocabulary: Money, currency, coins, cents, rands, how much, add, take away, buy, spend, pay, equals, calculate.

Prior knowledge: Learners should have been taught how to:

- Recognise and identify the South African currency coins/notes: 10c, 20c, 50c, R1, R2, R5 and R10.
- Solve money problems involving totals and change to R10 and in cents up to 20c.

Concepts:

- Solve money problems involving totals and change to R20 and in cents up to 20c.

Resources: Cut-out coins: 10c, 20c, 50c, R1, R2, R5, Cut-out notes: R10, R20 (see *Printable Resources*).

DBE workbook activities relevant to this lesson:

- DBE Worksheet 77 (pp. 26 and 27).

Assessment: Refer to the tracker for today's formal/informal oral, practical or written assessment activity.

Remediation: Give the learners the following coins and notes: R20, R10, R1, R2, R5, 20c, 10c. Ask the learners to show you as many combinations as they can that will give you a total of 20c and then of R15. (10c + 10c ; 20c; R10 + R5; R10 + R2 + R2 + R1; R5 + R5 + R5)

Enrichment: See enrichment activity cards.

1. Mental maths

1.1 Counting (5 minutes)

- Count forwards and backwards in 5s between 0 and 60.

1.2 Recall and strategies (10 minutes)

	Subtract the following:	Answer
1.	$4 - 2 = \underline{\quad}$	2
2.	$5 - 3 = \underline{\quad}$	2
3.	$4 - 1 = \underline{\quad}$	3
4.	$5 - 4 = \underline{\quad}$	1
5.	$3 - 0 = \underline{\quad}$	3

	Subtract the following:	Answer
6.	$3 - 1 = \underline{\quad}$	2
7.	$3 - 3 = \underline{\quad}$	0
8.	$2 - 1 = \underline{\quad}$	1
9.	$4 - 3 = \underline{\quad}$	1
10.	$5 - 1 = \underline{\quad}$	4

2. Correction/reflection on homework (15 minutes)

Reflection/remediation based on previous day's work/homework.

3. Lesson content – concept development (30 minutes)

Activity 1: Learners work in groups

Give the learners 4 x 10c coins, 2 x 20c coins, three 50c coins, a R20 note, a R10 note, two R5 coins, two R2 coins and four R1 coins.

- Ask learners to show you: 10c, 20c, 30c, R5, R10, R11, R1, R13, R14, R15, R16, R17, R18, R19, R20.
(Learners will hold up coins.)
- *Is this the only way you can show these amounts?* (Yes/No. Discuss)
- *Show me another way.* (Answers will vary, e.g. 10c and 10c for 20c, etc.)
- Ask learners to show you R11.
- *What will you do to make it R10?* (Take away R1.)
- Do the same with R12 to R20.

Activity 2: Learners work in groups

Ask the learners to work with the coins and notes and answer the following:

- *You have 10c. Your mom gives you 10c. How much money do you have now?* (20c)
- *You have 20c. You buy a sucker for 10c. How much money do you have left?* (10c)
- *You have R16. Your mom gives you R2. How much money do you have now?* (R18)
- *You have R18. You buy a ball for R15. How much money do you have left?* (R3)

Activity 3: Learners work individually

Calculate the following:

Addition with cents:

- $10c + 10c = \underline{\quad}$ (20c)

Subtraction with cents:

- $20c - 10c = \underline{\quad}$ (10c)
- $10c - 10c = \underline{\quad}$ (0c)

Addition with rands:

- $R10 + R6 = \underline{\quad}$ (R16)
- $R10 + R7 = \underline{\quad}$ (R17)
- $R9 + R5 = \underline{\quad}$ (R14)

Subtraction with rands:

- $R10 - R3 = \underline{\quad}$ (R7)
- $R14 - R4 = \underline{\quad}$ (R10)
- $R15 - R5 = \underline{\quad}$ (R10)

4. Classwork activity (25 minutes) (See next page)

5. Homework activity (5 minutes) (See next page)

6. Reflection on lesson

Term 3 Lesson 25: Money – addition and subtraction

Classwork

- Calculate the following:
 - $10c + 10c = \square$ (20c)
 - $10c - 10c = \square$ (0c)
 - $20c - 10c = \square$ (10c)
 - $R10 + R5 = \square$ (R15)
 - $R10 + R2 = \square$ (R12)
 - $R7 + R6 = \square$ (R13)
 - $R10 - R5 = \square$ (R5)
 - $R10 - R2 = \square$ (R8)
 - $R12 - R9 = \square$ (R3)
- Solve the following by writing a number sentence:
 - You had R12. Your mother gave you R5. How much money do you have now? ($R12 + R5 = R17$)
 - You have 20c. You buy a sweet for 10c. How much money do you have left? ($20c - 10c = 10c$)

Homework

- Solve the following by writing a number sentence:
 - You had 10c. Your mother gave you 10c and another 10c. How much money do you have now?
($10c + 10c + 10c = 30c$)
 - You have four 10c coins. You buy a sweet for 10c. How much money do you have left?
($40c - 10c = 30c$)

LESSON 26: GEOMETRIC PATTERNS

Teacher's notes

CAPS topics: 1.2 Count forwards and backwards, 1.16 Mental mathematics, 2.1 Geometric patterns.

Lesson vocabulary: Geometric, pattern, copy, extend, repeat, describe, lines, shapes, objects.

Prior knowledge: Learners should have been taught how to:

- Copy and extend simple patterns by using physical objects and drawings.
- Describe the pattern in words.
- Create and describe own geometric patterns with physical objects and by drawing lines, shapes or objects, Describe own patterns.

Concepts:

- Copy, extend and describe in words simple patterns made with physical objects and drawings of lines, shapes or objects.
- Create and describe own geometric patterns with physical objects and by drawing lines, shapes or objects.

Resources: Objects to use to make patterns (e.g. learners' stationery, ball, party hat, chalk, etc.), whiteboards/ scrap paper.

DBE workbook activities relevant to this lesson:

- DBE Worksheet 89 (pp. 50 and 51).

Assessment: Refer to the tracker for today's formal/informal oral, practical or written assessment activity.

Remediation: Find real-life objects that create a pattern. Show the first step of the pattern. Ask the learners to draw the pattern on their whiteboards/scrap paper. Assist them with extending the pattern.

Enrichment: See enrichment activity cards.

1. Mental maths

1.1 Counting (5 minutes)

- Count forwards and backwards in 2s from any multiple between 0 and 80, e.g. 51, 53, 55...

1.2 Recall and strategies (10 minutes)

	Put the numbers in order from the smallest to the biggest:	Answer
1.	12, 15, 14	12, 14, 15
2.	11, 8, 10	8, 10, 11
3.	15, 14, 13	13, 14, 15
4.	8, 5, 4	4, 5, 8
5.	7, 6, 8	6, 7, 8

	Put the numbers in order from the biggest to the smallest:	Answer
6.	14, 8, 10	14, 10, 8
7.	11, 9, 12	12, 11, 9
8.	10, 8, 12	12, 10, 8
9.	12, 13, 11	13, 12, 11
10.	11, 9, 10	11, 10, 9

2. Correction/reflection on homework (15 minutes)

Reflection/remediation based on previous day's work/homework.

3. Lesson content – concept development (30 minutes)

Refer to the *Dictionary of Mathematical Terms* for explanations and examples of the terminology relevant to the lesson (e.g. pattern and geometric pattern).

Activity 1: Learners work in groups

- Place some real-life objects on learners' desks so that they form a pattern.
- Ask the learners to copy your pattern (e.g. pencil crayon, pencil crayon, wax crayon, pencil crayon, pencil crayon, wax crayon ...).

Activity 2: Learners work in pairs

- Each learner must put out a pattern of real objects on his/her desk using the objects brought to class for this lesson (e.g. a ball; a party hat; a ball).
- Demonstrate that the pattern can be represented by clapping (e.g. 1 clap for the ball and 2 claps for the hat).
- Learners turn to the person sitting next to them to explain their pattern and to show it using claps.

Activity 3: Learners work individually

Use the DBE Worksheet 89 (p. 50) for this activity.

- Allow the learners to study the geometric patterns in the DBE Workbook.
- Learners should then copy and extend the patterns.
- Discuss the ways in which the patterns grow:
 - *Does the shape stay the same but the colour changes?*
 - *Do the shapes change?*
 - *Does the shape stay the same but the size of the shape changes?*
 - *Do the shape and the colour change?*

Activity 4: OPTIONAL

If there is time for you to do this activity before the learners must do the classwork activity, give learners whiteboards/ scrap paper to work on. Learners could also do this once they finish the classwork activity, if they have time.

- Ask the learners to draw geometric shapes and create their own patterns using geometric shapes.
- Learners can swop patterns with a friend and then extend their friend's pattern.

4. Classwork activity (25 minutes) (See next page)

5. Homework activity (5 minutes) (See next page)

6. Reflection on lesson

Term 3 Lesson 26: Geometric patterns

Classwork

1. Draw the next group of shapes in the pattern.

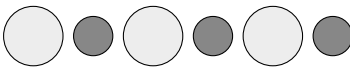
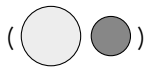
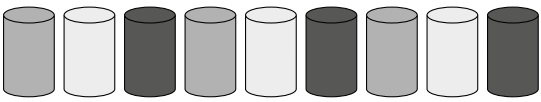
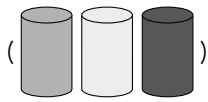
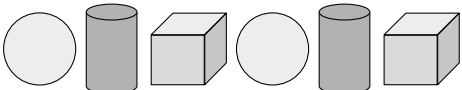
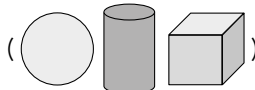
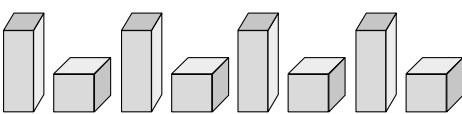
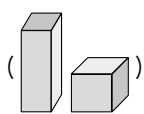
a)		()
b)		()
c)		()
d)		()

2. Draw your own pattern. (Answers will vary.)

3. Paste pictures from a magazine to show your own pattern. (Answers will vary.)

Homework

Use some of these coloured shapes to create your own pattern and then repeat the pattern.
(Answers will vary.)

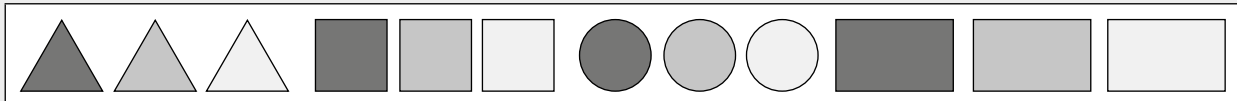

LESSON 27: PATTERNS – TENS, FIVES AND TWOS UP TO 50

Teacher's notes

CAPS topics: 1.1 Count objects, 1.2 Count forwards and backwards, 1.16 Mental mathematics, 2.2 Number patterns.

Lesson vocabulary: How many, groups, lots of, add, addition, plus, equals, remainder.

Prior knowledge: Learners should have been taught how to:

- Create and describe own number patterns.
- Count in tens, fives and twos from any multiple of 10, 5 or 2 between 0 and 50.

Concepts:

- Copy, extend and describe simple number sequences to at least 80: 2s and 5s.
- Create and describe own number patterns.

Resources: 1–80 number boards (one per group) (see *Printable Resources*), a floor number-line, counters.

DBE workbook activities relevant to this lesson:

- DBE Worksheet 82 (pp. 36 and 37).
- DBE Worksheet 83 (pp. 38 and 39).

Assessment: Refer to the tracker for today's formal/informal oral, practical or written assessment activity.

Remediation: Give learners the 1–80 number board and ask them to place counters on the tens, fives or twos by counting the correct number of places each time. Encourage them to say the numbers out loud as they count up so that they can see how we get to the multiples of ten/five/two.

Enrichment: See enrichment activity cards.

1. Mental maths

1.1 Counting (5 minutes)

- Count forwards and backwards in 2s between 0 and 70.

1.2 Recall and strategies (10 minutes)

	Which number is 1 more than:	Answer
1.	3	4
2.	14	15
3.	8	9
4.	7	8
5.	5	6

	Which number is 1 more than:	Answer
6.	11	12
7.	4	5
8.	12	13
9.	10	11
10.	13	14

2. Correction/reflection on homework (15 minutes)

Reflection/remediation based on previous day's work/homework.

3. Lesson content – concept development (30 minutes)

This is the first of three lessons on number patterns this term. In this lesson you revise the number patterns of 10, 5s and 2s – counting in these patterns up to 50. Connections are made between counting patterns and number lines to help learners develop their number concept of multiples.

Activity 1: Whole class activity

- Recap with learners the counting patterns they have done before: 10s, 5s and 2s.
- Do some oral counting activities with the class as a warm up for the next two activities:
 - Count in 10s to 50, starting at 0.
 - Count in 5s to 50, starting at 0.
 - Count in 2s to 50, starting at 0.

Activity 2: Whole class activity

- Practice number-line counting by placing or drawing a number line on the floor using chalk (from zero to 20).
- Make sure the learners start by standing on zero.
- Learners then take one step forward to one, so that they understand that the step from zero to one is the first step.
- *Let us stand on zero and take five steps forward.*
- Counting in 5s: Learners say the number every time they step on a multiple of 5 (5, 10, 15, 20).
- Counting in 2s: Learners say the number every time they step on a multiple of 2 (2, 4, 6, 8, 10, 12, 14, 16, 18, 20).
- Counting in 10s: Learners say the number every time they step on a multiple of 10 (10, 20).
- Discuss: *What do you notice about the number of multiples between 0 and 20 of the patterns that you have counted?* (There are more multiples of 2 than of 5 and of 10. Etc.)

Activity 3: Learners work in groups

Give each group of learners a 1–80 number board and some counters.

- Ask learners to place counters on 5, 10, 15, 20, 25, 30, 35, 40, 45, 50.
- Encourage them to point at the numbers and count in fives (5, 10, 15, 20, 25, 30, 35, 40, 45, 50).
- Put up your number cards (in multiples of fives) on the board.
- Point to each of the cards and practice counting in 5s to 50.
- Count in 10s and in 2s using the number board if there is time, but make sure to leave enough time for the learners to work individually on the classwork activities to consolidate their learning.
- Discuss:
 - *Which multiples of 2 are also multiples of 10? (Many – e.g. 10, 20, 30, etc.)*
 - *Which multiples of 5 are also multiples of 10? (Many – e.g. 10, 20, 30, etc.)*
 - *What do you notice about the multiples of 2 and 5 that are also multiples of 10? (They are all 10s.)*

4. Classwork activity (25 minutes) (See next page)

5. Homework activity (5 minutes) (See next page)

6. Reflection on lesson

Term 3 Lesson 27: Patterns – tens, fives and twos up to 50

Classwork

1. Complete the number lines by filling in the missing numbers:

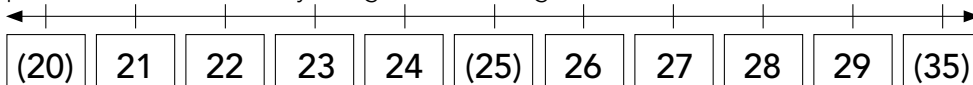
a) 

(20)	21	22	23	24	(25)	26	27	28	29	(35)
------	----	----	----	----	------	----	----	----	----	------

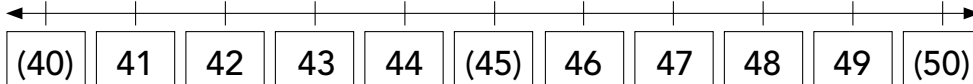
b) 

(40)	41	42	43	44	(45)	46	47	48	49	(50)
------	----	----	----	----	------	----	----	----	----	------

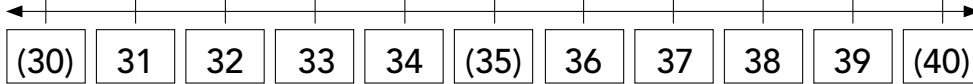
c) 

(30)	31	32	33	34	(35)	36	37	38	39	(40)
------	----	----	----	----	------	----	----	----	----	------

2. Colour all the multiples of 2 in the table. The first three have been done for you.

1	2	3	4	5	6	7	(8)	9	(10)
11	(12)	13	(14)	15	(16)	17	(18)	19	(20)
21	(22)	23	(24)	25	(26)	27	(28)	29	(30)
31	(32)	33	(34)	35	(36)	37	(38)	39	(40)
41	(42)	43	(44)	45	(46)	47	(48)	49	(50)

3. Colour all the multiples of 5 in the table. The first three have been done for you.

1	2	3	4	5	6	7	8	9	10
11	12	13	14	15	16	17	18	19	20
21	22	23	24	(25)	26	27	28	29	(30)
31	32	33	34	(35)	36	37	38	39	(40)
41	42	43	44	(45)	46	47	48	49	(50)

4. Which multiples of 5 are also multiples of 10?

5. Count on in 2s from each of the given numbers. Complete the number lines to show the counting.

a) 

20	(22)	(24)	(26)	(28)	(30)
----	------	------	------	------	------

b) 

40	(42)	(44)	(46)	(48)	(50)
----	------	------	------	------	------

c) 

30	(32)	(34)	(36)	(38)	(40)
----	------	------	------	------	------

Homework

1. Complete the number lines by filling in the missing numbers:

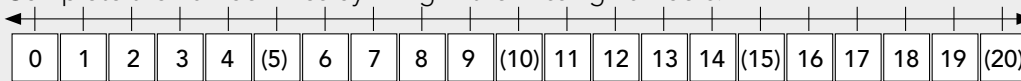

0	1	2	3	4	(5)	6	7	8	9	(10)	11	12	13	14	(15)	16	17	18	19	(20)
---	---	---	---	---	-----	---	---	---	---	------	----	----	----	----	------	----	----	----	----	------

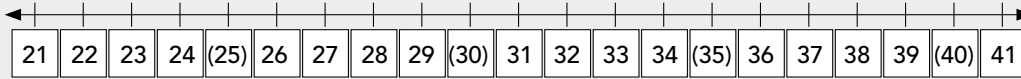

21	22	23	24	(25)	26	27	28	29	(30)	31	32	33	34	(35)	36	37	38	39	(40)	41
----	----	----	----	------	----	----	----	----	------	----	----	----	----	------	----	----	----	----	------	----

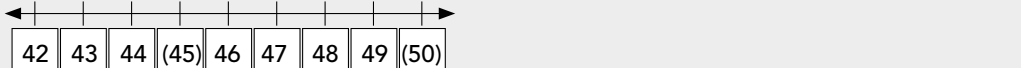

42	43	44	(45)	46	47	48	49	(50)
----	----	----	------	----	----	----	----	------

LESSON 28: PATTERNS – FIVES AND TENS UP TO 80

Teacher's notes

CAPS topics: 1.1 Count objects, 1.2 Count forwards and backwards, 1.16 Mental mathematics, 2.2 Number patterns.

Lesson vocabulary: How many, groups, lots of, add, addition, plus, equals, remainder.

Prior knowledge: Learners should have been taught how to:

- Create and describe own number patterns.
- Count in tens, fives and twos from any multiple of 10, 5 or 2 between 0 and 50.

Concepts:

- Copy, extend and describe simple number sequences to at least 80: 5s and 10s.
- Create and describe own number patterns.

Resources: 1–80 number boards (one per group) (see *Printable Resources*), counters, number cards (multiples of 5) (see *Printable Resources*), whiteboards/scrap paper.

DBE workbook activities relevant to this lesson:

- DBE Worksheet 84 (pp. 40 and 41).

Assessment: Refer to the tracker for today's formal/informal oral, practical or written assessment activity.

Remediation: Give learners the 1–80 number board and ask them to place counters on the fives. Let them count out loud while doing it. Talk about the patterns of five that they see on the number board.

Enrichment: See enrichment activity cards.

1. Mental maths

1.1 Counting (5 minutes)

- Count forwards and backwards in 2s between 0 and 70, e.g. 48, 50, 52 ...

1.2 Recall and strategies (10 minutes)

	Which number is 1 less than:	Answer
1.	8	7
2.	14	13
3.	15	14
4.	7	6
5.	5	4

	Which number is 1 less than:	Answer
6.	11	10
7.	9	8
8.	12	11
9.	10	9
10.	13	12

2. Correction/reflection on homework (15 minutes)

Reflection/remediation based on previous day's work/homework.

3. Lesson content – concept development (30 minutes)

In this lesson you look at the fives and the tens patterns. This will help learners to realise that there are connections between the number patterns. In this lesson they will consolidate their learning of the 5s and 10s number patterns but they will also see that there are some multiples of 5 that are also multiples of 10.

Activity 1: Learners work in groups

Give each group of learners a 1–80 number board.

- Ask learners to place counters on 10, 20, 30, 40, 50, 60, 70, 80.
- Encourage them to point at the numbers and count in tens while they do this (10, 20, 30, 40, 50, 60, 70, 80).
- Ask: *What multiples have we just shown on the number board?* (10s, or the multiples of 10.)
- Ask learners to place counters on 5, 10, 15, 20, 25, 30, 35, 40, 45, 50, 55, 60, 65, 70, 75, 80.
- Encourage them to point at the numbers and count in fives while they do this (5, 10, 15, 20, 25, 30, 35, 40, 45, 50, 55, 60, 65, 70, 75, 80).
- Ask: *What multiples have we just shown on the number board?* (5s, or the multiples of 5.)
- Discuss: *We have looked at patterns of 10s and 5s on the number board. What did you notice?* (Answers may vary but encourage learners to see that some of the multiples of 5 are also multiples of 10.)

Activity 2: Learners work individually

- Ask learners to write out the multiples of 5 from 5 to 80 on whiteboards/scrap paper.
- Ask learners to draw arrows from one number to the next, showing that 5 is added each time.

5 → 10 → 15 → 20 → 25 → 30 → ... 80
 +5 +5 +5 +5 +5 +5

- Ask: *How do the numbers in the 5s sequence grow?* (Learners give use different explanations but they should clarify that 5 and 5 is 10, and 10 and 5 is 15, 15 and 5 is 20, and so on, up to 80. This shows that the terms in the number pattern of 5s are made by adding 5 each time.)
- Say: *Look again at the 5s pattern that you have written on your whiteboards/scrap paper – circle all of the multiples of 10.* (Learners circle 10, 20, 30, ... 80.)
- Draw arrows from one number in the tens pattern to the next, showing that 10 is added each time.

5 → 10 → 15 → 20 → 25 → 30 → ... 80
 +5 +5 +5 +5 +5 +5
 +10 +10 +10

- Ask: *How do the numbers in the 10s sequence grow?* (Learners give different explanations but they should clarify that 10 and 10 is 20, and 20 and 10 is 30, and so on, up to 80. This shows that the terms in the number pattern of 10s are made by adding 10 each time.)

Activity 3: Whole class activity (Optional if time allows)

Write the following patterns (of 5 and 10) on the board and work with the class to fill in the missing numbers:

- 5, 10, 15, ____, ____, 25
- 0, ____, ____, 30, 40
- 50, 55, ____, ____, ____, 75, 80
- 40, ____, ____, 70, 80
- etc.

4. Classwork activity (25 minutes) (See next page)

5. Homework activity (5 minutes) (See next page)

6. Reflection on lesson

Term 3 Lesson 28: Patterns – fives and tens up to 80

Classwork

Note that in this activity you could remind learners to refer to the table to check for multiples which are common to the 5s and 10s patterns.

1. Complete the number lines by filling in the missing numbers:

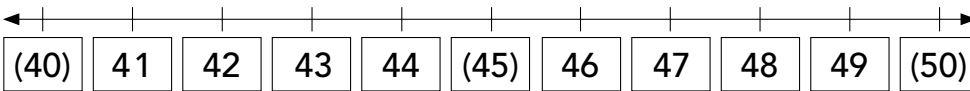
a) 

(40)	41	42	43	44	(45)	46	47	48	49	(50)
------	----	----	----	----	------	----	----	----	----	------

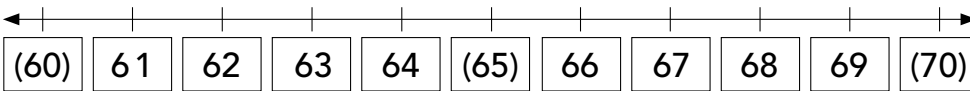
b) 

(60)	61	62	63	64	(65)	66	67	68	69	(70)
------	----	----	----	----	------	----	----	----	----	------

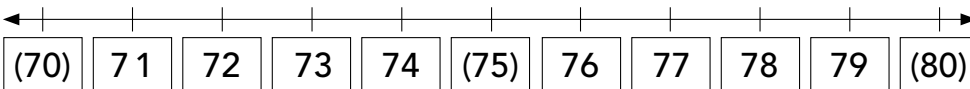
c) 

(70)	71	72	73	74	(75)	76	77	78	79	(80)
------	----	----	----	----	------	----	----	----	----	------

2. Colour all the multiples of 5 in the table.

41	42	43	44	(45)	46	47	48	49	(50)
51	52	53	54	(55)	56	57	58	59	(60)
61	62	63	64	(65)	66	67	68	69	(70)
71	72	73	74	(75)	76	77	78	79	(80)

3. Which multiples of 5 are also multiples of 10?

4. Fill in the missing numbers in the patterns:

- 30, 35, 40, __, __, 55 (45, 50)
- __, __, 60, 65, 70 (50, 55)
- 40, __, __, 70 (50, 60)
- 20, 30, 40, __, __, 70, 80 (50, 60)

Homework

1. Complete the number lines by filling in the missing numbers:

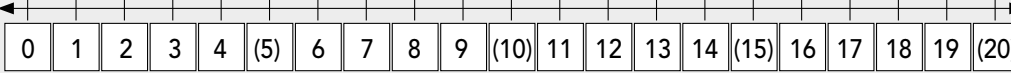

0	1	2	3	4	(5)	6	7	8	9	(10)	11	12	13	14	(15)	16	17	18	19	(20)
---	---	---	---	---	-----	---	---	---	---	------	----	----	----	----	------	----	----	----	----	------

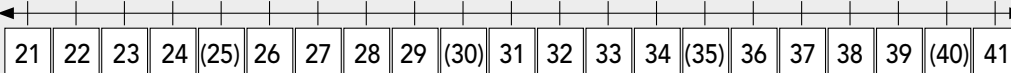

21	22	23	24	(25)	26	27	28	29	(30)	31	32	33	34	(35)	36	37	38	39	(40)	41
----	----	----	----	------	----	----	----	----	------	----	----	----	----	------	----	----	----	----	------	----

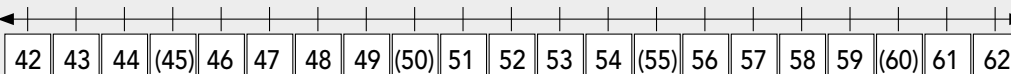

42	43	44	(45)	46	47	48	49	(50)	51	52	53	54	(55)	56	57	58	59	(60)	61	62
----	----	----	------	----	----	----	----	------	----	----	----	----	------	----	----	----	----	------	----	----



63	64	(65)	66	67	68	69	(70)	71	72	73	74	(75)	76	77	78	79	(80)
----	----	------	----	----	----	----	------	----	----	----	----	------	----	----	----	----	------

WEEK 8

LESSON 29: PATTERNS – TWOS AND TENS UP TO 80

Teacher's notes

CAPS topics: 1.1 Count objects, 1.2 Count forwards and backwards, 1.16 Mental mathematics, 2.2 Number patterns.

Lesson vocabulary: How many, groups, lots of, add, addition, plus, equals, remainders, number patterns, number sequences.

Prior knowledge: Learners should have been taught how to:

- Create and describe own number patterns.
- Count in tens, fives and twos from any multiple of 10, 5 or 2 between 0 and 50

Concepts:

- Copy, extend and describe simple number sequences to at least 80: 2s and 10s.
- Create and describe own number patterns.

Resources: 1–80 number boards (one per group) (see *Printable Resources*), counters, whiteboards/scrap paper.

DBE workbook activities relevant to this lesson:

- DBE Worksheet 93 (pp. 58 and 59).

Assessment: Refer to the tracker for today's formal/informal oral, practical or written assessment activity.

Remediation: Give learners the 1–80 number board and ask them to place counters on the twos by counting two places each time. Encourage them to say the numbers out loud as they count up so that they can see how we get to the multiples of two. Talk about the patterns of two that they see on the number board.

Enrichment: See enrichment activity cards.

1. Mental maths

1.1 Counting (5 minutes)

- Count forwards and backwards in 2s from any multiple between 0 and 80, e.g. 52, 54, 56 ...

1.2 Recall and strategies (10 minutes)

	Which number is 2 more than?	Answer
1.	10	12
2.	12	14
3.	9	11
4.	11	13
5.	13	15

	Which number is 2 more than?	Answer
6.	4	6
7.	8	10
8.	7	9
9.	6	8
10.	5	7

2. Correction/reflection on homework (15 minutes)

Reflection/remediation based on previous day's work/homework.

3. Lesson content – concept development (30 minutes)

In this lesson you look again at the tens pattern, but this time in combination with the 2s pattern. This will help learners to realise that there are connections between the number patterns. In this lesson they will consolidate their learning of the 2s and 10s patterns but they will also see that there are some multiples of 2 that are also multiples of 10.

Activity 1: Learners work in groups

Give each group of learners a 1–80 number board.

- Ask learners to place counters on 10, 20, 30, 40, 50, 60, 70, 80.
- Encourage them to point at the numbers and count in tens while they do this. (10, 20, 30, 40, 50, 60, 70, 80.)
- Ask: *What multiples have we just shown on the number board?* (10s, or the multiples of 10.)
- Ask learners to place counters on 2, 4, 6, 8 ... 50.
- Encourage them to point at the numbers and count in twos. (2, 4, 6, 8, 10, 12, 14, 16, 18, 20, 22, 24, 26, 28, 30, 32, 34, 36, 38, 40, 42, 44, 46, 48, 50.)
- Ask: *What multiples have we just shown on the number board?* (2s, or the multiples of 2.)
- Discuss: *We have looked at patterns of 10s and 2s on the number board. What did you notice?* (Answers may vary but encourage learners to see that some of the multiples of 2 are also multiples of 10.)

Activity 2: Learners work individually

- Ask learners to write out the multiples of 2 from 40 to 80 on whiteboards/scrap paper.
- Ask learners to draw arrows from one number to the next, showing that 2 is added each time.

40 → 42 → 44 → 46 → 48 → 50 → 52 ... 80
+2 +2 +2 +2 +2 +2

- Ask: *How do the numbers in the 2s sequence grow?* (Learners use different explanations but they should clarify that $40 + 2$ is 42, $42 + 2$ is 44, $44 + 2$ is 46 and so on, up to 80. This shows that the terms in the number pattern of 2s are made by adding 2 each time.)
- Say: *Look again at the 2s pattern that you have written on your whiteboards/scrap paper – circle the multiples of 10.* (Learners circle 40, 50, ... 80.)
- *Draw arrows from one number in the tens pattern to the next, showing that 10 is added each time.*
- *Draw arrows from one number in the tens pattern to the next, showing that 10 is added each time.*

40 → 42 → 44 → 46 → 48 → 50 → 52 ... 80
+2 +2 +2 +2 +2 +2
+10

- Ask: *Explain how the numbers in the 10s sequence grow.* (Learners should point out that the 10s grow by adding 10 each time.)

Activity 3: Whole class activity

Write the following patterns (of 2 and 10) on the board and work with the class to fill in the missing numbers:

- 22, 24, 26, __, __, 32
- 10, __, __, 40, 50
- 66, 68, __, __, 74, 76, 78
- 50, __, __, 80
- etc.

4. Classwork activity (25 minutes) (See next page)

5. Homework activity (5 minutes) (See next page)

6. Reflection on lesson

Term 3 Lesson 29: Patterns – twos and tens up to 80

Note that in this activity you could remind learners to refer to the table to check for multiples which are common to the 5s and 10s patterns.

Classwork

1. Count in 2s to complete the following number lines:

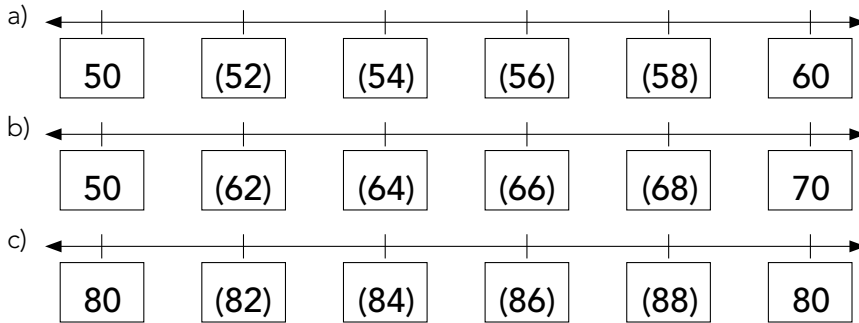

2. Colour all of the multiples of 2 in the table. The first three have been done for you.

41	42	43	44	45	46	47	(48)	49	(50)
51	(52)	53	(54)	55	(56)	57	(58)	59	(60)
61	(62)	63	(64)	65	(66)	67	(68)	69	(70)
71	(72)	73	(74)	75	(76)	77	(78)	79	(80)

3. Which multiples of 2 are also multiples of 10?

4. Fill in the missing numbers in the patterns:

- 30, 32, 34, __, __, 40 (36, 38)
- __, __, 60, 62, 64 (56, 58)
- 30, __, __, 60 (40, 50)
- 0, 10, __, __, 40 (20, 30)

Homework

1. Fill in the missing numbers. Then show hoops counting in 2s on the number line.

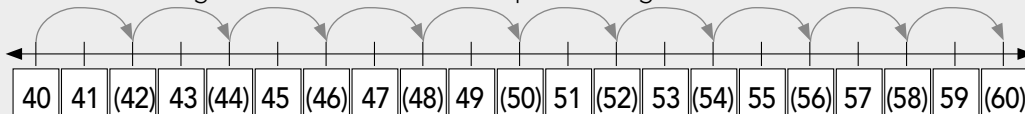

LESSON 30: REPEATED ADDITION UP TO 15 – FIVES

Teacher's notes

CAPS topics: 1.1 Count objects, 1.2 Count forwards and backwards, 1.16 Mental mathematics, 1.12 Techniques (methods or strategies), 1.8, 1.14 Repeated addition leading to multiplication.

Lesson vocabulary: How many, groups of, lots of, add, addition, plus, equals.

Prior knowledge: Learners should have been taught how to:

- Solve word problems in context and explain own solution to problems involving addition with answers up to 10.
- Count in fives from any multiple of 5 between 0 and 50.
- Do repeated addition of fives up to 10.

Concepts:

- Repeated addition leading to multiplication: Repeated addition (i.e. adding the same number); use the appropriate symbols (+, =, □).
- Repeated addition of fives up to 15.



Resources: Unifix blocks. *For preparation* – drawings of a variety of groups of five shapes, e.g. some hands with five fingers, packets of 5 fruit in each, etc.

DBE workbook activities relevant to this lesson:

- DBE Worksheet 81 (pp. 34 and 35).

Assessment: Refer to the tracker for today's formal/informal oral, practical or written assessment activity.

Remediation: Give the learners 15 Unifix blocks. Practice counting in 5s. Count using the blocks.

- Ask learners to make 5 group of 5 and say: 1 group of 5 is 5.  Count 5.
Ask learners to make 2 groups of 5 and say: 2 groups of 5 is 10.  Count 5, 10.
Ask learners to make 3 groups of 5 and say: 3 groups of 5 is 15.  Count 5, 10, 15.

Enrichment: See enrichment activity cards.

1. Mental maths

1.1 Counting (5 minutes)

- Count forwards and backwards in 5s from any multiple between 0 and 80, e.g. 80, 75, 70 ...

1.2 Recall and strategies (10 minutes)

	What is double:	Answer
1.	5	10
2.	7	14
3.	4	8
4.	6	12
5.	3	6

	What is half of:	Answer
6.	8	4
7.	10	5
8.	12	6
9.	14	7
10.	6	3

2. Correction/reflection on homework (15 minutes)

Reflection/remediation based on previous day's work/homework.

3. Lesson content – concept development (30 minutes)

This is the first of two lessons on repeated addition leading to multiplication. In Grade 1 learners do not learn the multiplication sign (they record their working using repeated addition only) but it is important that they become aware of problems involving repeated addition as this does lead them into multiplication. The important idea to stress in these two lessons is that we can add several groups of (or lots of) a certain number. This is done by linking the addition to real objects that embody groups/lots of different numbers.

Activity 1: Whole class activity

Use your prepared drawings for this activity.

- Show a picture of 3 hands each with 5 fingers.
- *What do you see?* (3 hands)
- *How many fingers on each hand?* (5)
- *How many groups of 5 do you see?* (3)
- *Let's count in fives.* (5, 10, 15)
- *How many fingers altogether?* (15)
- *How can I show that as a number sentence?* ($5 + 5 + 5 = 15$)
- Show a picture of 2 packets with 5 apples in each.
- *What do you see?* (2 packets)
- *How many apples in each packet?* (5)
- *How many groups of 5 do you see?* (2)
- *Let's count in fives.* (5, 10)
- *How many apples altogether?* (10)
- *How can I show that as a number sentence?* ($5 + 5 = 10$)
- Repeat with other numbers and pictures.

Activity 2: Whole class activity

Give the learners 15 Unifix cubes each.

You could ask different learners to come up and write the different number sentences on the board during this activity.

- Ask them to take 5 counters and make one group.
- *We can say: I have 1 lot of 5 or 1 group of 5.*
- *We can write it like this: $0 + 5 = 5$ (write this on the board).*
- Do the same with 2 groups of 5
- *We can say: I have 2 lots of 5 or 2 groups of 5.*
- *We can write this as $5 + 5 = 10$.*
- Repeat the same steps for 3 groups of 5 ($5 + 5 + 5 = 15$)

4. Classwork activity (25 minutes) (See next page)



5. Homework activity (5 minutes) (See next page)

6. Reflection on lesson

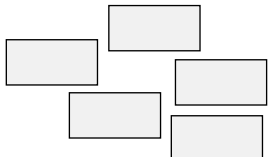
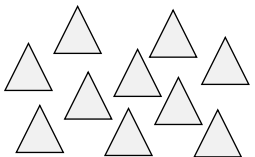

Term 3 Lesson 30: Repeated addition up to 15 – fives

Classwork

1. Fill in the numbers and draw circles around the following to make:

<p>a) 1 group of 5 =</p>  <p>(5)</p>	<p>b) 2 groups of 5 =</p>  <p>(10)</p>	<p>c) 3 groups of 5 =</p>  <p>(15)</p>
---	---	---

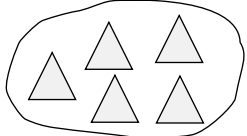
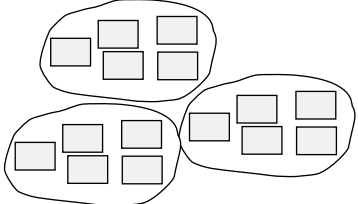
2. Write number sentences for the following:

<p>a)</p>  <p>$(0 + 5 = 5)$</p>	<p>b)</p>  <p>$(5 + 5 + 5 = 10)$</p>	<p>c)</p>  <p>$(5 + 5 = 10)$</p>
---	---	--

3. There are 3 friends. They have 5 sweets each. How many sweets do they have altogether?

Draw counters and write a number sentence.

(●●●●● ●●●●● ●●●●● $5 + 5 + 5 = 15$)

Homework

1. I have 2 plates. There are 5 apples on each plate. How many apples are there altogether?

Draw counters and write a number sentence.

(●●●●● ●●●●● $5 + 5 = 10$)

LESSON 31: REPEATED ADDITION UP TO 15 – TWOS

Teacher's notes

CAPS topics: 1.1 Count objects, 1.2 Count forwards and backwards, 1.16 Mental mathematics, 1.12 Techniques (methods or strategies), 1.14 Repeated addition leading to multiplication.

Lesson vocabulary: How many, groups of, lots of, add, addition, plus, equals.

Prior knowledge: Learners should have been taught how to:

- Solve word problems in context and explain own solution to problems involving addition with answers up to 10.
- Count in twos from any multiple of 2 between 0 and 50.
- Do repeated addition of twos up to 10.

Concepts:

- Repeated addition leading to multiplication: Repeated addition (i.e. adding the same number); use the appropriate symbols (+, =, □).
- Repeated addition of twos up to 15.



Resources: Unifix blocks. *For preparation* – drawings of a variety of groups of 2 shapes, e.g. bicycles, packets of 2 sweets, etc. (see Lesson 30).

DBE workbook activities relevant to this lesson:

- DBE Worksheet 91 (pp. 54 and 55).

Assessment: Refer to the tracker for today's formal/informal oral, practical or written assessment activity.

Remediation: Give the learners 10 Unifix blocks – practice counting in 2s.

- Ask learners to make 1 group of 2 and say: 1 group of 2 is 2.  Count 2.
- Ask learners to make 2 groups of 2 and say: 2 groups of 2 is 4.  Count 2, 4.
- Ask learners to make 3 groups of 2 and say: 3 groups of 2 is 6.  Count 2, 4, 6.

Enrichment: See enrichment activity cards.

1. Mental maths

1.1 Counting (5 minutes)

- Count forwards and backwards in 1s, 2s, 5s and 10s from 0 and 80, e.g. 68, 66, 64 ...

1.2 Recall and strategies (10 minutes)

	Which number is 2 less than?	Answer
1.	10	8
2.	12	10
3.	9	7
4.	11	9
5.	13	11

	Which number is 2 less than?	Answer
6.	4	2
7.	8	6
8.	14	12
9.	6	4
10.	15	13

2. Correction/reflection on homework (15 minutes)

Reflection/remediation based on previous day's work/homework.

3. Lesson content – concept development (30 minutes)

Activity 1: Whole class activity

Use your prepared drawings for this activity.

- Show a picture of 3 bicycles each with 2 wheels.
- *What do you see?* (3 bicycles.)
- *How many wheels on each bicycle?* (2)
- *How many groups of 2 do you see?* (3)
- *Let's count in twos.* (2, 4, 6)
- *How many wheels altogether?* (6)
- *How can I show that as a number sentence?* ($2 + 2 + 2 = 6$)
- Show a picture of 5 packets with 2 sweets in each.
- *What do you see?* (5 packets.)
- *How many sweets in each packet?* (2)
- *How many groups of 2 do you see?* (5)
- *Let's count in twos.* (2, 4, 6, 8, 10)
- *How many sweets altogether?* (10)
- *How can I show that as a number sentence?* ($2 + 2 + 2 + 2 + 2 = 10$)
- Repeat with other numbers and pictures.

Activity 2: Whole class activity

Give the learners 14 Unifix blocks each.

You could ask different learners to come up and write the different number sentences on the board during this activity.

- Ask them to take 2 Unifix blocks and make one group.
- *We can say: 1 lot of 2 or 1 group of 2.*
- *We can write it like this: $0 + 2 = 2$* (write this on the board).
- Do the same with 2 groups of 2
- *We can say: I have 2 lots of 2 or 2 groups of 2.*
- *We write this as $2 + 2 = 4$.*
- Similarly for 3 groups of 2.
- *We can say: I have 3 lots of 2 or 3 groups of 2.*
- *We write this as $2 + 2 + 2 = 6$, etc.*

4. Classwork activity (25 minutes) (See next page)

5. Homework activity (5 minutes) (See next page)

6. Reflection on lesson

Term 3 Lesson 31: Repeated addition up to 15 – twos

Classwork

1. Fill in the numbers and draw circles around the following to make:

<p>a) 4 groups of 2 =</p>	<p>b) 5 groups of 2 =</p>	<p>c) 6 groups of 2 =</p>	<p>d) 7 groups of 2 =</p>
---------------------------	---------------------------	---------------------------	---------------------------

2. Write number sentences for the following:

a) $(2 + 2 + 2 + 2 + 2 + 2 = 12)$	b) $(2 + 2 + 2 + 2 + 2 = 10)$	c) $(2 + 2 + 2 + 2 + 2 + 2 + 2 + 2 = 14)$	d) $(2 + 2 + 2 + 2 = 8)$

3. Draw counters and write a number sentence: There are 6 friends. They have 2 sweets each. How many sweets do they have altogether?

(●● ●● ●● ●● ●● ●● $2 + 2 + 2 + 2 + 2 + 2 = 12$)

4. How many legs are there? Write a number sentence for each picture.

a) $(2 + 2 + 2 = 6)$

b) $(2 + 2 + 2 + 2 + 2 = 10)$

c) $(2 + 2 + 2 + 2 = 8)$

Homework

1. Draw counters and write a number sentence: I have 7 plates. There are 2 apples on each plate. How many apples are there altogether?

(●● ●● ●● ●● ●● ●● ●● $2 + 2 + 2 + 2 + 2 + 2 + 2 = 14$)

LESSON 32: SYMMETRY

Teacher's notes

CAPS topics: 1.2 Count forwards and backwards, 1.16 Mental mathematics, 3.4 Symmetry.

Lesson vocabulary: 2-D shapes, geometric shapes, non-geometric shapes, symmetry, symmetrical, the same.

Prior knowledge: Learners should have been taught how to:

- Recognise symmetry in their own bodies.

Concepts:

- Recognise and draw line of symmetry in 2-D geometrical and non-geometrical shapes.

Resources: For preparation – cut-out cardboard shapes, symmetrical pictures.

DBE workbook activities relevant to this lesson:

- DBE Worksheet 94 (pp. 60 and 61).

Assessment: Refer to the tracker for today's formal/informal oral, practical or written assessment activity.

Remediation: Give the learners some cut-out cardboard shapes. Ask them to fit two pieces together to make a whole shape.

Enrichment: See enrichment activity cards.

1. Mental maths

1.1 Counting (5 minutes)

- Count forwards and backwards in 5s from any multiple between 0 and 80, e.g. 56, 61, 66...

1.2 Recall and strategies (10 minutes)

	Double the following:	Answer
1.	5	10
2.	7	14
3.	4	8
4.	6	12
5.	3	6

	Halve the following:	Answer
6.	8	4
7.	12	6
8.	10	5
9.	14	7
10.	6	3

2. Correction/reflection on homework (15 minutes)

- Reflection/remediation based on previous day's work/homework.

3. Lesson content – concept development (30 minutes)

This is the first lesson on the concept of symmetry that Grade 1 learners will have. Symmetry is one of the important properties of shapes that learners need to know about in geometry. In this lesson there is some new vocabulary but there is also some familiar vocabulary from the topic of 2-D geometry. Be sure to refer to the *Dictionary of Mathematical Terms* if you need to for definitions and examples of the vocabulary used in this lesson.

Activity 1: Whole class activity

- Draw the following on the board. (The line divides the shape into two shapes which look exactly the same.)

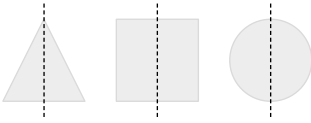

- *What do you notice?* (The shapes have a line through them. Notice also the way in which it divides the shapes – into two reflected halves.)
- Discuss the following with the learners:
 - *The dotted line is called the 'line of symmetry'*
 - *The dotted line divides the shape in half so that the two sides look **exactly** the same.*

Activity 2: Whole class activity

- Ask the learners to copy a triangle, square and circle from the board into their books.



- Ask learners to draw the dotted line down the middle of each shape.

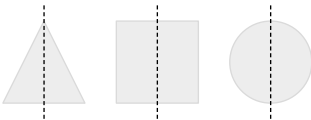

- *What is this line called?* (The line of symmetry.)
- *What does it do?* (It divides the shape in half so that the two sides look exactly the same.)

Activity 3: Whole class activity

Draw the following on the board:

- Ask learners to draw the other half of each shape.

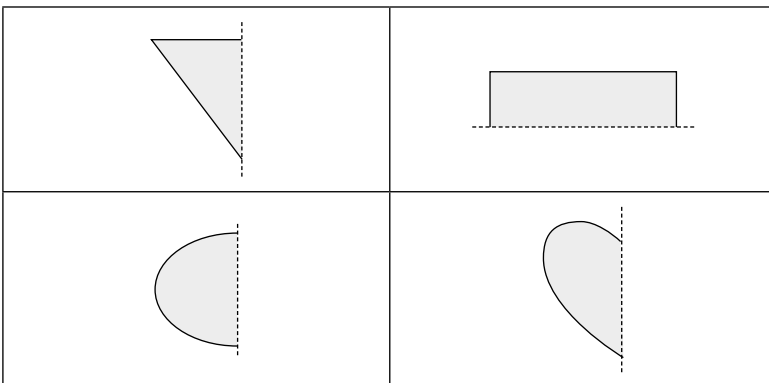

4. Classwork activity (25 minutes) (See next page)

5. Homework activity (5 minutes) (See next page)

6. Reflection on lesson

Term 3 Lesson 32: Symmetry

Classwork

1. Colour the pieces that will form one shape the same colour.

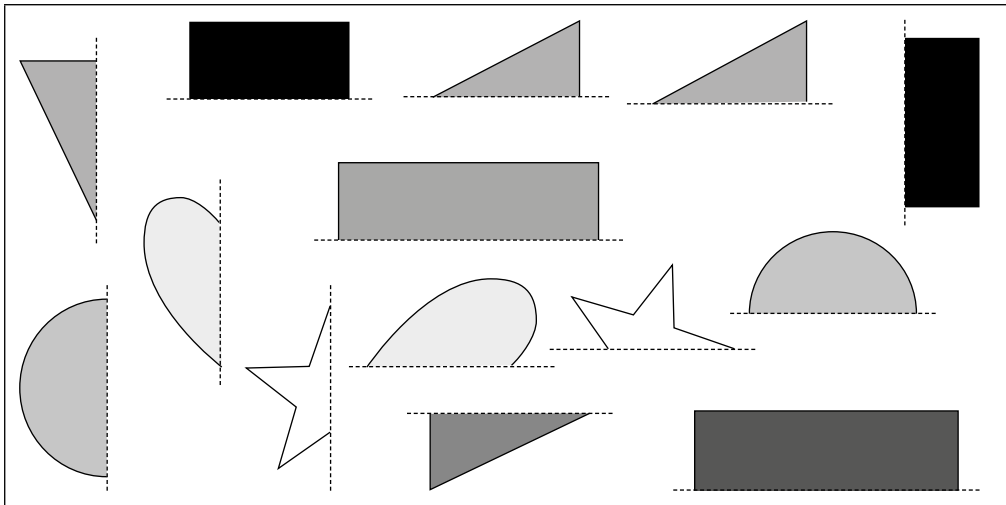

2. Draw the other half.

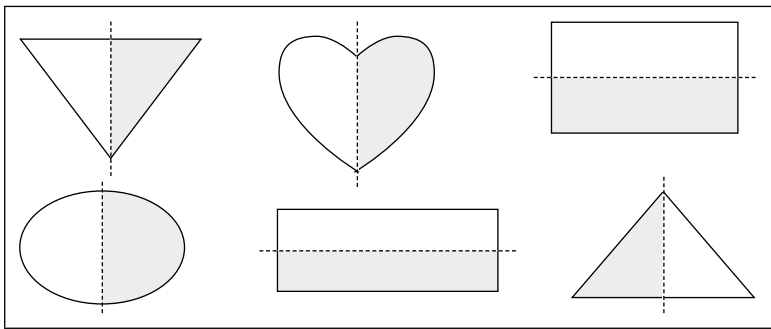

3. Draw a line to divide the picture into two so that both sides look exactly the same.

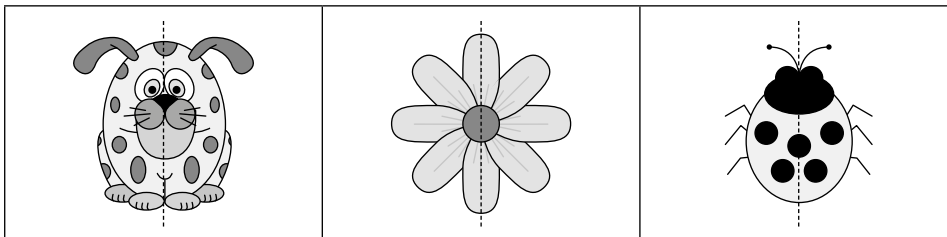

Homework

1. Draw four symmetrical shapes. (Answers may vary.)
2. Draw the line of symmetry into your shapes. (Draw into the shapes that learners did. Check that lines are correct lines of symmetry)

WEEK 9

LESSON 33: GROUPING

Teacher's notes

CAPS topics: 1.1 Count objects, 1.2 Count forwards and backwards, 1.16 Mental mathematics, 1.9 Grouping and sharing leading to division.

Lesson vocabulary: How many, groups of, lots of, equals, remainder, grouping, sharing.

Prior knowledge: Learners should have been taught how to:

- Solve problems by grouping and sharing using whole numbers up to 10.
- Count in twos, fives and tens from any multiple of 2, 5 or 10 between 0 and 50.
- Do repeated addition of tens, twos and fives up to 10.

Concepts:

- Solve and explain solutions to practical problems involving equal grouping with whole numbers up to 15 and with answers that may include remainders.

Resources: Counters.

DBE workbook activities relevant to this lesson:

- DBE Worksheet 80 (pp. 32, 33).

Assessment: Refer to the tracker for today's formal/informal oral, practical or written assessment activity.

Remediation: Give each learner 15 counters. Give learners a word problem: *Mufaro has 9 sweets which he needs to pack into bags. He puts 2 sweets in each bag. How many bags will he need?* Help learners to use their counters to solve the problem. *Tell me how you solved the problem?* (We put the counters into groups of 2, and then saw we had 4 groups and one sweet left over.) *What will you do with the left over sweet?* (Learners can come up with a variety of answers.) Repeat with other word problems.

Enrichment: See enrichment activity cards.

1. Mental maths

1.1 Counting (5 minutes)

- Count forwards and backwards in 1s, 2s, 5s and 10s from 0 and 80, e.g. 68, 66, 64 ...

1.2 Recall and strategies (10 minutes)

	Add the following:	Answer
1.	$_ + 2 = 5$	3
2.	$_ + 1 = 4$	3
3.	$_ + 2 = 4$	2
4.	$_ + 3 = 4$	1
5.	$_ + 4 = 4$	0

	Add the following:	Answer
6.	$_ + 4 = 5$	1
7.	$_ + 3 = 5$	2
8.	$_ + 5 = 5$	0
9.	$_ + 2 = 3$	1
10.	$_ + 1 = 5$	4

2. Correction/reflection on homework (15 minutes)

Reflection/remediation based on previous day's work/homework.

3. Lesson content – concept development (30 minutes)

This is the first of two lessons on division in the third term. This lesson focuses on grouping division. In the first activity the grouping leaves no remainder, while in the second activity learners work with remainders. Remember that division is the inverse of multiplication. In this lesson you will refer to multiples when you find groups that make up a given number. You could point out to learners that this is because of the inverse relationship between division and multiplication.

Activity 1: Learners work in groups

Give each group of learners 15 counters.

- Ask learners to put 10 counters in front of them.
- Ask the learners to put the counters into groups of 2. (●● ●● ●● ●● ●●)
- How many groups of 2 do you have? (5 groups of 2.)
- So, 5 groups of 2 makes 10.
- If I divide 10 into groups of 2 I get 5 groups. 10 divided by 2 equals 5.
- Ask learners to put 16 counters in front of them.
- Ask the learners to put the counters into groups of 4. (●●●● ●●●● ●●●● ●●●●)
- How many groups of 4 do you have? (4 groups of 4.)
- So, 4 groups of 4 makes 16.
- If I divide 16 into groups of 4, I get 4 groups. 16 divided by 4 equals 4.
- Repeat with other numbers.

Activity 2: Learners work in groups

Continue working with the 15 counters.

- Ask learners to put 13 counters in front of them.
- Ask the learners to put the counters into groups of 3. (●●● ●●● ●●● ●●● ●)
- How many groups of 3 do you have? (4 groups of 3.)
- Did all the counters fit into a group of 3? (No, there was 1 left over.)
- So, 13 divided into groups of 3 gives 4 groups of 3 with 1 left over.
- This shows that 13 divided by 3 equals 4 remainder 1.
- Ask learners to put 17 counters in front of them.
- Ask the learners to put the counters into groups of 5. (●●●●● ●●●●● ●●●●● ●●)
- How many groups of 5 do you have? (3 groups of 5.)
- Did all the counters fit into a group of 5? (No, there were 2 left over.)
- So, 17 divided into groups of 5 gives 3 groups of 5 with 2 left over.
- This shows that 17 divided by 5 equals 3 remainder 2
- Repeat with other numbers.

Activity 3: Learners work in groups

Continue working with the 15 counters.

- Give learners a word problem.
*Cleo has 20 cookies that must be packed into boxes. 5 cookies go in each box.
How many boxes will she need?*
- Ask learners to use their counters to solve the problem.
(●●●●● ●●●●● ●●●●● ●●●●● 4 boxes)
- Tino has 11 marbles that he puts into groups. He puts 3 marbles in each group. How many groups does he have?
- Ask learners to use their counters to solve the problem.
(●●● ●●● ●●● ●●● 3 groups with 2 marbles left over)
- Repeat with other numbers.

4. Classwork activity (25 minutes) (See next page)

5. Homework activity (5 minutes) (See next page)

6. Reflection on lesson

Term 3 Lesson 33: Grouping

Classwork

1. Solve the following:

a) ●●●●●●●●●●

How many groups of 2 can you make? (5)

b) ●●●●●●●●

How many groups of 4 can you make? (2)

c) ●●●●●●●●●●

How many groups of 3 can you make? (4)

d) ●●●●●●●●●●

How many groups of 6 can you make? (2)

2. Draw a picture to solve the problems:

a) Tom has 12 eggs. He packs them into boxes. Each box holds 6 eggs. How many boxes will he use?

○○○○○○ ○○○○○○ (2 boxes)

b) Mpho has 10 flowers. She puts the flowers into bunches. She puts 3 flowers in each bunch.

How many bunches will she make?

(☼☼☼ ☼☼☼ ☼☼☼ ☼ 3 bunches and one flower left over)

c) Phindi has 9 pencil crayons. She packs the crayons into boxes. She puts 2 pencil crayons in a box. How many boxes will she need?

(     4 boxes and she will have 1 pencil left over)

Homework

1. Solve the following:

a) ●●●●●●●●

How many groups of 3 can you make? (3)

b) ●●●●●●●●●●

How many groups of 5 can you make? (3 and one ball is left over)

c) ●●●●●●●●●●

How many groups of 12 can you make? (1)

LESSON 34: SHARING

Teacher's notes

CAPS topics: 1.1 Count objects, 1.2 Count forwards and backwards, 1.16 Mental mathematics, 1.9 Grouping and sharing leading to division.

Lesson vocabulary: How many, lots of, groups of, equals, sharing, remainder, grouping, sharing.

Prior knowledge: Learners should have been taught how to:

- Solve problems by grouping and sharing using whole numbers up to 10.
- Count in twos, fives and tens from any multiple of 2, 5 or 10 between 0 and 50.
- Do repeated addition of tens, twos and fives up to 10.

Concepts:

- Solve and explain solutions to practical problems involving equal sharing with whole numbers up to 15 and with answers that may include remainders.

Resources: Counters.

DBE workbook activities relevant to this lesson:

- N/A

Assessment: Refer to the tracker for today's formal/informal oral, practical or written assessment activity.

Remediation: Give each learner 15 counters. Give learners a word problem: *Khani has 10 sweets which she shares between 3 friends. How many sweets will each friend get?* Help learners to use their counters to solve the problem. *Tell me how you solved the problem?* (We shared the counters into 3 groups, and then saw we had 3 groups and one sweet left over.) *What will you do with the left over sweet?* (Learners can come up with a variety of answers.) Repeat with other word problems.

Enrichment: See enrichment activity cards.

1. Mental maths

1.1 Counting (5 minutes)

- Count forwards and backwards in 1s, 2s, 5s and 10s from 0 and 80, e.g. 68, 66, 64 ...

1.2 Recall and strategies (10 minutes)

	Add the following:	Answer
1.	$4 + \underline{\quad} = 5$	1
2.	$3 + \underline{\quad} = 4$	1
3.	$1 + \underline{\quad} = 5$	4
4.	$5 + \underline{\quad} = 5$	0
5.	$0 + \underline{\quad} = 3$	3

	Add the following:	Answer
6.	$2 + \underline{\quad} = 4$	2
7.	$1 + \underline{\quad} = 3$	2
8.	$2 + \underline{\quad} = 5$	3
9.	$2 + \underline{\quad} = 3$	1
10.	$3 + \underline{\quad} = 5$	2

2. Correction/reflection on homework (15 minutes)

Reflection/remediation based on previous day's work/homework.

3. Lesson content – concept development (30 minutes)

This is the second of two lessons on division in the third term. This lesson focuses on sharing division. In the first activity the sharing leaves no remainder, while in the second activity learners work with remainders.

Term 3 Lesson 34: Sharing

Classwork

1. Solve the following:

a) 

Share the pencils between 7 children. How many pencils will each child get? (2)

b) 

Share the flowers between 2 children. How many flowers will each child get? (3)

c) 

Share the books between 3 children. How many books will each child get? (4)

d) 

Share the balls between 5 children. How many balls will each child get? (2)

2. Draw a picture to solve the problems:

a) Share 10 sweets between 3 friends. How many sweets will each friend get?

( 3 sweets each, 1 sweet left over )

b) Share 15 flowers between 4 people. How many flowers will each person get?

( 3 flowers each, 3 flowers left over )

c) Share 4 pencils between 3 people. How many pencils will each person get?

( 1 pencil left over )

Homework

1. Solve the following:

a) 

Share the pencils between 4 children. How many pencils will each child get? (2)

b) 

Share the balls between 5 children. How many balls will each child get? (3)

c) 

Share the flowers between 5 children. How many flowers will each child get? (1 and 1 flower left over)

LESSON 35: GROUPING AND SHARING

Teacher's notes

CAPS topics: 1.1 Count objects, 1.2 Count forwards and backwards, 1.16 Mental mathematics, 1.9 Grouping and sharing leading to division.

Lesson vocabulary: How many, groups of, lots of, equals, remainder, grouping, sharing.

Prior knowledge: Learners should have been taught how to:

- Solve problems by grouping and sharing using whole numbers up to 10.
- Count in twos, fives and tens from any multiple of 2, 5 or 10 between 0 and 50.
- Do repeated addition of tens, twos and fives up to 10.

Concepts:

- Solve and explain solutions to practical problems involving equal sharing and grouping with whole numbers up to 15 and with answers that may include remainders.

Resources: Counters.

DBE workbook activities relevant to this lesson:

- DBE Worksheet 90, (pp. 52 and 53).
- DBE Worksheet 92, (pp. 56 and 57).

Assessment: Refer to the tracker for today's formal/informal oral, practical or written assessment activity.

Remediation: Give each learner 15 counters. Give learners word problems that call for grouping or sharing in their solution. For example: *If I share 8 counters between 2 friends, how many counters does each one get?* OR *How many groups of 2 can I make if I have 10 counters?* Encourage them to use the counters if they need to use them to work out the solution. Show them how to write their solutions using correct number sentences.

Enrichment: See enrichment activity cards.

1. Mental maths

1.1 Counting (5 minutes)

- Count forwards and backwards in 2s from any multiple between 0 and 80, e.g. 52, 54, 56 ...

1.2 Recall and strategies (10 minutes)

	Which number is less?	Answer
1.	11 or 3	3
2.	9 or 12	9
3.	5 or 9	5
4.	10 or 6	6
5.	13 or 15	13

	Which number is more?	Answer
6.	10 or 13	13
7.	4 or 8	8
8.	11 or 12	12
9.	13 or 14	14
10.	7 or 6	7

2. Correction/reflection on homework (15 minutes)

Reflection/remediation based on previous day's work/homework.

3. Lesson content – concept development (30 minutes)

In this lesson you consolidate the learning about grouping and sharing. In this lesson you will also stress the mathematical vocabulary of division – grouping, sharing and remainders. Look at the lesson vocabulary list (and the *Dictionary of Mathematical Terms*) to recap the terminology relevant to the lesson.

Activity 1: Learners work in groups

- Give each group of learners 15 counters.
- Ask the learners to group the counters into 2s.
- *How many groups of 2 did you make? (7 and I had 1 counter left over.)*
- Discuss the activity of grouping into 2s (put 2 counters together each time).
- Talk about the remainder. The mathematical name for the counters we have left over is the remainder. Ask a few different learners to give you examples of number sentences with a remainder. They must use the correct mathematical language when they tell you their examples. Ask them to give grouping and sharing examples. Help them if necessary. For example:
- Sharing:
I share 6 sweets between 5 friends. Each friend gets one sweet and there is one sweet left over.
- Grouping:
I have 15 sweets and I want to sell them in bags with 5 sweets in a bag. I can make 3 bags and I have no sweets left over – there is no remainder.
- Call on as many different examples as learners want to give, try to encourage many different learners to participate.

Activity 2: Learners work individually

Give learners a 1–80 number board.

- Ask learners to place counters on 2, 4, 6, 8 ... 50.
- Encourage them to point at the numbers and count in twos (2, 4, 6, 8, 10, 12, 14, 16, 18, 20, 22, 24, 26, 28, 30, 32, 34, 36, 38, 40, 42, 44, 46, 48, 50).

4. Classwork activity (25 minutes) (See next page)

5. Homework activity (5 minutes) (See next page)

6. Reflection on lesson

Term 3 Lesson 35: Grouping and sharing

Classwork

1. Solve the following:

a) ●●●●●●●●

How many groups of 4 can you make? \square (2 remainder 0)

b) ●●●●●●●●●●

How many groups of 3 can you make? \square (3 remainder 1)

c) ●●●●●●●●●●

How many groups of 4 can you make? \square (2 remainder 2)

d) ●●●●●●●●●●●●●●

How many groups of 10 can you make? \square (1 remainder 3)

2. Share the balls between the given number of friends:

a) ●●●●●●●●●●●●●●●●

Share 15 balls between 5 friends. Each one gets \square balls. (3 remainder 0)

b) ●●●●●●●●●●

Share 11 balls between 3 friends. Each one gets \square balls. (3 remainder 2)

c) ●●●●●●●●●●

Share 11 balls between 2 friends. Each one gets \square balls. (5 remainder 1)

d) ●●●●●●●●●●●●●●

Share 15 balls between 4 friends. Each one gets \square balls. (3 remainder 3)

3. Draw a picture to solve the problems:

a) Thompho has 15 flowers. She puts the flowers into bunches. She puts 3 flowers in each bunch. How many bunches will she make?

( 5 bunches and no flowers left over)

b) Ntombi has 9 pencil crayons. She packs the crayons into boxes. She puts 5 pencil crayons in a box. How many boxes will she need?

( 1 box will have 5 and another box which will only have 4 pencils)

Homework

1. Solve the following:

a) ●●●●●●●●●●●●●●●●

How many groups of 3 can you make? \square (5)

b) ●●●●●●●●●●

Share 10 balls between 5 friends. Each one gets \square balls. (2 remainder 0)

c) ●●●●●●●●●●●●●●

How many groups of 4 can you make? \square (3 remainder 2)

d) ●●●●●●●●

Share 7 balls between 2 friends. Each one gets \square balls. (3 remainder 1)

LESSON 36: 3-D OBJECTS – SLIDE AND ROLL

Teacher's notes

CAPS topics: 1.2 Count forwards and backwards, 1.16 Mental mathematics, 3.2 3-D objects.

Lesson vocabulary: Balls, boxes, big, small, balance, describe, sort, compare, flat side, curved side, roll, slide.

Prior knowledge: Learners should have been taught how to:

- Recognise and name 3-D objects in the classroom and in pictures.
- Describe, sort and compare objects in terms of size and colour.
- Observe and build given 3-D objects using concrete materials

Concepts:

- Describe, sort and compare 3-D objects in terms of objects that roll and objects that slide.

Resources: Boxes and balls of various shapes and sizes.

DBE workbook activities relevant to this lesson:

- DBE Worksheet 88 (pp. 48 and 49).

Assessment: Refer to the tracker for today's formal/informal oral, practical or written assessment activity.

Remediation: Take the learners outside. Give them a variety of balls and boxes. Find a slope or build one. Learners then roll the balls and slide the boxes to each other. *We say that a ball rolls. We say that a box slides.* Instruct the learners to find one object that can roll and slide and observe as they let it roll down the slope and then slide down the slope.

Enrichment: See enrichment activity cards.

1. Mental maths

1.1 Counting (5 minutes)

- Count forwards and backwards in 10s from any multiple between 0 and 80, e.g. 70, 60, 50 ...

1.2 Recall and strategies (10 minutes)

	How many jumps backwards from:	Answer
1.	11 to 8	3
2.	9 to 6	3
3.	13 to 11	2
4.	14 to 9	5
5.	12 to 7	5

	How many jumps backwards from:	Answer
6.	15 to 14	1
7.	10 to 5	5
8.	7 to 5	2
9.	8 to 3	5
10.	10 to 9	1

2. Correction/reflection on homework (15 minutes)

- Reflection/remediation based on previous day's work/homework.

3. Lesson content – concept development (30 minutes)

There are three lessons this term on 3-D objects. Remember to collect as many different examples of ball and box shaped objects to bring to the lesson. It is very important for learners to work with real examples of 3-D shapes while they are learning about them. The focus of this lesson is the nature of the faces of the shapes.

Activity 1: Learners work in groups

- Place a variety of box and ball-shaped objects in the middle of each group of learners.
- Instruct the learners to sort the objects.
- They should explain to you how they sorted them. (These are boxes and those are balls. They might go into more detail – listen to all of their explanations. Some of them might lead into the next activity of this lesson which is about curved and flat faces of 3-D shapes. Always build on what the learners offer in the conversation when this is possible as this shows the learners that you listen to them and respect what they say.)

Activity 2: Learners work in groups

- Learners continue to work with the balls, objects shaped like balls, various boxes and other objects shaped like rectangular prisms or cubes that you gave them for the first activity.
- Ask each group of learners to make a slope using a large book/other objects that they can work with.
- Using the slope that they have made, learners should investigate which of the objects can roll, and which can slide. The teacher should circulate and facilitate this discovery activity.
- *What do you notice?* (Learners will discover that ball-shaped objects will roll down the incline and box-shaped objects will slide down the incline.)
- Learners will also discover that some objects are able to slide and roll because they have both a flat and a curved side, e.g. toilet roll, tin can, yoghurt tub.
- Draw together the class into a group discussion once all groups have had time to investigate the properties of 3-D shapes. Discuss ideas such as the following:
 - *What side does the shape roll on if it has flat and curved sides? (The curved one.)*
 - *What side does the shape slide on if it has flat and curved sides? (The flat side.)*
 - Do shapes need a slope to roll or slide? (No, they can be pushed on a flat surface and roll or slide, depending on the types of faces they have.)
 - Etc. Discuss other points that learners raise.

4. Classwork activity (25 minutes) (See next page)





5. Homework activity (5 minutes) (See next page)

6. Reflection on lesson

Term 3 Lesson 36: 3-D objects – slide and roll

Classwork

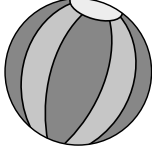
1. Will these objects roll or slide? Write the correct answer.

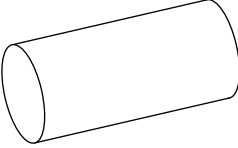
			
a) (roll)	b) (slide)	c) (slide)	d) (roll)
			
e) (roll)	f) (roll and slide)	g) (roll and slide)	

Homework

(Answers may vary)

1. Find four objects at home. Make a slope by placing a box under one end of a big book.
2. Test each object to see whether it can roll or slide.
3. Draw the objects that can roll on the left side of your page and the objects that can slide on the right side of your page.
4. Label your group of pictures: roll/slide.

WEEK 10

LESSON 37: 3-D OBJECTS – SIZE

Teacher's notes

CAPS topics: Count forwards and backwards, 1.16 Mental mathematics, 3.2 3-D objects.

Lesson vocabulary: 3-D objects, size, describe, sort, compare, slide, roll, big, small, bigger than, smaller than, biggest, smallest.

Prior knowledge: Learners should have been taught how to:

- Recognise and name 3-D objects in the classroom and in pictures.
- Describe, sort and compare objects in terms of size and colour.
- Observe and build given 3-D objects using concrete materials.

Concepts:

- Describe, sort and compare 3-D objects in terms of size, colour, objects that roll, objects that slide.

Resources: Box shapes, ball shapes (various sizes and colours), pictures of boxes and balls of various sizes and colours (collect from magazines and make a poster of these).

DBE workbook activities relevant to this lesson:

- DBE Worksheet 87 (pp. 46 and 47).

Assessment: Refer to the tracker for today's formal/informal oral, practical or written assessment activity.

Remediation: Place a small, medium and big ball on the learners' desks. Hold up a ball and then say: *Give me a ball smaller than this one. Now give me a ball bigger than this one.* Repeat with another ball. Then do the same using a small, medium and big box.

Enrichment: See enrichment activity cards.

1. Mental maths

1.1 Counting (5 minutes)

- Count forwards and backwards in 1s, 2s, 5s and 10s from any multiple between 0 and 80, e.g. 80, 70, 60...

1.2 Recall and strategies (10 minutes)

	Subtract the following:	Answer
1.	$3 - 1 - 1 = \underline{\quad}$	1
2.	$5 - 2 - 2 = \underline{\quad}$	1
3.	$4 - 2 - 2 = \underline{\quad}$	0
4.	$5 - 2 - 1 = \underline{\quad}$	2
5.	$5 - 1 - 1 = \underline{\quad}$	3

	Subtract the following:	Answer
6.	$4 - 2 - 1 = \underline{\quad}$	1
7.	$5 - 0 - 1 = \underline{\quad}$	4
8.	$3 - 2 - 1 = \underline{\quad}$	0
9.	$4 - 1 - 1 = \underline{\quad}$	2
10.	$4 - 1 - 0 = \underline{\quad}$	3

2. Correction/reflection on homework (15 minutes)

- Reflection/remediation based on previous day's work/homework.

3. Lesson content – concept development (30 minutes)

Remember to bring the different examples of ball and box shaped objects that you have collected to this lesson. The focus of this lesson is the size of the object. This is another property which learners use to distinguish between objects. In this lesson the colour of the objects is also taken into consideration.

There is a lot of vocabulary in this lesson relating to size – check the lesson vocabulary list and the *Dictionary of Mathematical Terms* to make sure you give the correct meanings of these words to learners. Allow them as many opportunities as possible to use the words themselves when they talk about the objects during the lesson.

Activity 1: Learners work in groups

Give each group of learners some balls and boxes of different sizes and colours.

The following are just examples, you can use any colours that you can find for the balls and boxes and talk about the sizes in relation to the objects that you have collected.

Ask learners to:

- *Show me a ball smaller than the green ball.*
- *Show me a box smaller than the pink box.*
- *Show me a ball bigger than the blue ball.*
- *Show me a box bigger than the red box.*
- Repeat with similar questions.

Activity 2: Whole class activity

Put pictures of boxes and balls of various sizes and colours on the board.

Ask learners questions such as the questions below. Adapt these questions to the pictures that you have found – refer to the colour and size of the shapes in your pictures.

- Compare pairs of objects:
 - *Which is bigger: the purple box or the green box?*
 - *Which is bigger: the orange ball or the blue ball?*
 - *What is smaller than the blue ball?*
 - *What is smaller than the pink box?*
- Ask learners to give you other examples of objects smaller than: the orange box; the pink box; the orange ball, etc.
- Ask learners to give you other examples of objects bigger than: the green ball; the yellow box; the green box, etc.
- Remind learners that when we compare two objects we say 'bigger' or 'smaller'.
- Compare three (or more) objects:
 - *Which is the biggest object?*
 - *Which is the smallest object?*
- Remind learners that when we compare three or more objects, the one that is bigger than all of the objects is the biggest object. (Similarly for the smallest object.)

4. Classwork activity (25 minutes) (See next page)

5. Homework activity (5 minutes) (See next page)

6. Reflection on lesson



Term 3 Lesson 37: 3-D objects – size

Classwork

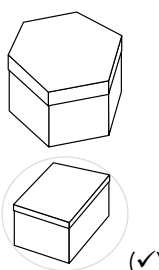
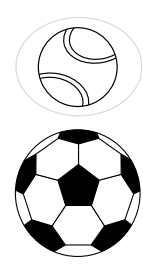
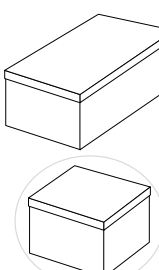
1. Circle the smaller object.

<p>a)</p> 	<p>b)</p> 	<p>c)</p> 
---	---	---

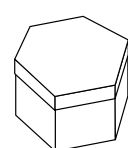
2. Draw the objects below. Then draw a bigger object next to each one. (Answers may vary.)

<p>a)</p> 	<p>(Answers may vary.)</p>
<p>b)</p> 	<p>(Answers may vary.)</p>
<p>c)</p> 	<p>(Answers may vary.)</p>

3. Draw the objects below. Then draw a smaller object next to each one. (Answers may vary.)

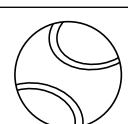
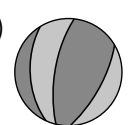
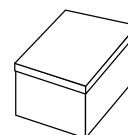
<p>a)</p> 	<p>(Answers may vary.)</p>
<p>b)</p> 	<p>(Answers may vary.)</p>
<p>c)</p> 	<p>(Answers may vary.)</p>

4. Draw 3 different sized balls. Label them small, smaller, smallest. (Answers may vary.)

5. Draw 3 different sized boxes. Label them big, bigger, biggest. (Answers may vary.)

Homework

1. Draw one ball that is smaller and one ball that is bigger than this ball.



(Answers may vary.)

2. Draw one box that is smaller and one box that is bigger than this box.

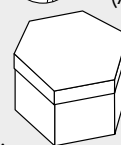

(Answers may vary.)

LESSON 38: BUILDING WITH 3-D OBJECTS

Teacher's notes

CAPS topics: 1.2 Count forwards and backwards, 1.16 Mental mathematics, 3.2 3-D objects.

Lesson vocabulary: Big, small, bigger than, smaller than, biggest, smallest, balance, tall, taller, tallest, ball shape, box shapes, sort, describe, sort, compare, 3-D objects, size, colour, roll, slide.

Prior knowledge: Learners should have been taught how to:

- Recognise and name 3-D objects in the classroom and in pictures.
- Describe, sort and compare objects in terms of size and colour.
- Observe and build given 3-D objects using concrete materials.

Concepts:

- Recognise and name 3-D objects in the classroom—ball shapes, box shapes.
- Describe, sort and compare 3-D objects in terms of size, colour, objects that roll, objects that slide.

Resources: Box shapes, ball shapes (various sizes and colours), poster of box and ball shapes, old magazines and scissors. Optional: play dough/home-made salt dough.

DBE workbook activities relevant to this lesson:

- N/A

Assessment: Refer to the tracker for today's formal/informal oral, practical or written assessment activity.

Remediation: Assist learners in making balls with curved sides and boxes with flat sides with their play dough (if you have play dough). Help them to successfully balance their objects. Assist learners in describing curved and flat sides. Discuss the differences. Discuss which objects will balance and why (flat faces can balance on top of each other).

Enrichment: See enrichment activity cards.

1. Mental maths

1.1 Counting (5 minutes)

- Count forwards and backwards in 1s from any number between 0 and 80, e.g. 63, 64, 65...

1.2 Recall and strategies (10 minutes)

	Add the following:	Answer
1.	$3 + 1 = \underline{\quad}$	4
2.	$2 + 3 = \underline{\quad}$	5
3.	$2 + 2 = \underline{\quad}$	4
4.	$1 + 3 = \underline{\quad}$	4
5.	$4 + 1 = \underline{\quad}$	5

	Subtract the following:	Answer
6.	$3 - 1 = \underline{\quad}$	2
7.	$5 - 3 = \underline{\quad}$	2
8.	$4 - 2 = \underline{\quad}$	2
9.	$5 - 1 = \underline{\quad}$	4
10.	$4 - 1 = \underline{\quad}$	3

2. Correction/reflection on homework (15 minutes)

Reflection/remediation based on previous day's work/homework.

3. Lesson content – concept development (30 minutes)

Remember to bring the different examples of ball and box shaped objects that you have collected to this lesson. In this lesson learners think about which objects can be used to build. The types of faces that an object has affects the usefulness of an object as building material. This lesson therefore consolidates learners' knowledge of the properties of 3-D objects.

You need old magazines or newspapers in this lesson.

Activity 1: Learners work in groups

Give each group of learners a variety of boxes and balls.

- Ask them to build a tower using all the objects that they have been given.
- *Is it difficult to build a tower of shapes? (Yes/No – discuss the reasons learners give for their answers – this will lead to the properties of shapes.)*
- *Were you able to build a tower successfully using all your boxes and balls? (Yes/No.)*
- *What made it possible for an object balance on top of another object? Discuss all answers.*
 - Size – smaller objects can balance on top of bigger objects.
 - Encourage discussion of the fact that the bigger objects needed to be at the bottom of the tower, so that the tower does not become top-heavy and over-balance.
 - The sides of the object – flat faces can balance on top of each other. Curved/round faces cannot balance on top of each other.
- *What makes it difficult to build a tower using objects? Discuss all answers.*
 - Balancing the objects
 - The sizes of the objects
 - Round objects cannot balance.

Activity 2: Learners work in groups

Give each group of learners some old magazines from which they will cut pictures of objects.

- Cut out 5 box and 5 ball objects.
- Paste the objects into your Maths books grouped under the correct heading (box/ball objects).
- Discuss as a class whether the objects the groups have found could be used to build a tower.

4. Classwork activity (25 minutes) (See next page)

5. Homework activity (5 minutes) (See next page)



6. Reflection on lesson

Term 3 Lesson 38: Building with 3-D objects

Note that in this lesson Learners could draw their pictures in answer to Questions 2 and 3 of the classwork if you do not have enough old magazines/advertisement flyers/newspapers to go around.

Classwork

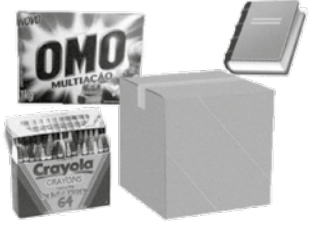
1. Can you build a tower with all the following objects? Write yes or no.

					
(Yes)	No	(Yes)	No	Yes	(No)

2. Cut and paste four pictures from a magazine to make a tower that you think could balance.

3. Cut and paste four pictures from a magazine that you think could not balance.

Homework

1. Find five objects from around your home.
2. Balance them to make a tower that does not fall over.
3. Draw the tower that you built.

LESSON 39: CAPACITY

Teacher's notes

CAPS topics: 1.2 Count forwards and backwards, 1.16 Mental mathematics, 4.4 Capacity/Volume.

Lesson vocabulary: Capacity, full, empty, more than, less than, the same as, liquid, pouring, containers, compare, estimate, order, amount, measure, record, liquid, cups, spoons.

Prior knowledge: Learners should have been taught how to:

- Compare and order the amount of liquid that two containers can hold if filled (capacity).
- Use language to talk about the comparison.

Concepts:

- Compare and order the amount of liquid that two containers can hold if filled.
- Use language to talk about the comparisons e.g. more than, less than, full, empty.
- Estimate, measure, compare, order and record the capacity of containers using non-standard measures e.g. spoons and cups.

Resources: Bring from home: A variety of 1 litre and 2 litre containers, a variety of 500ml containers, some large jugs, sand or water, cups, old magazines or newspapers, three containers with the same volume but different sizes.

DBE workbook activities relevant to this lesson:

- DBE Worksheet 126 (p. 124).

Assessment: Refer to the tracker for today's formal/informal oral, practical or written assessment activity.

Remediation: Give the learners two 1 litre containers that are different objects, e.g. a 1 litre coke bottle and 1 litre yoghurt tub. Ask: *Which container will hold the most water/sand?* See if the learners were correct by filling the one container and then pour the sand/water from the one container to the next. Repeat using two more containers that will hold the same amount but look different.

Enrichment: See enrichment activity cards.

1. Mental maths

1.1 Counting (5 minutes)

- Count forwards and backwards in 1s, 2s, 5s and 10s from 0 and 80, e.g. 65, 60, 55 ...

1.2 Recall and strategies (10 minutes)

	Which number is 2 less than?	Answer
1.	14	12
2.	10	8
3.	11	9
4.	9	7
5.	15	13

	Which number is 2 more than?	Answer
6.	4	6
7.	8	10
8.	13	15
9.	6	8
10.	12	14

2. Correction/reflection on homework (15 minutes)

Reflection/remediation based on previous day's work/homework.

3. Lesson content – concept development (30 minutes)

This lesson provides learners with an opportunity to recap the concept of capacity. Remember to use all of the vocabulary and encourage the learners to use all of the vocabulary as well. Refer to the *Dictionary of Mathematical Terms* if you need to for definitions and examples of the vocabulary used in this lesson.

Activity 1: Whole class activity

- Place various containers on your table to use for demonstration purposes during the class discussion.
- Discuss the following questions with learners.
- Place a few different containers on the table for the first discussion. Ask:
 - *Which container will hold the most water?* Allow the learners to discuss and give you their answers. They should give reasons. Allow them to hold and demonstrate using the containers when they explain their answers.
 - *Which container will hold the least amount of water?* Allow the learners to discuss and give you their answers.
- Place two different one litre containers on your table. Ask:
 - *Which container will hold the most water?* Allow the learners to discuss and give you their answers and their reasons.
 - *Which container will hold the least amount of water?* Allow the learners to discuss and give you their answers and their reasons.
- Pour water from the one container to the next to show that they take the same amount of water.

Activity 2: Learners work in groups

Place different sized containers on the desks of each group of learners.

- Allow learners to experiment with the containers in the following way. (Continue this as a whole class demonstration if you do not have sufficient containers or space in your class to allow groups to work on the activity.)
- Hold up one empty container and encourage the learners to describe what they see. (The container is empty.)
- Fill one container with water/sand and encourage the learners to describe what they see now. (The container is full.)
- Pour out half of the water/sand.
- Encourage the learners to describe what they see. (The container is half full.)
- Repeat this with two or three more containers.

4. Classwork activity (25 minutes) (See next page)

5. Homework activity (5 minutes) (See next page)

6. Reflection on lesson



Term 3 Lesson 39: Capacity

Classwork

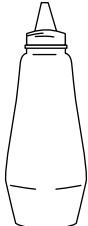
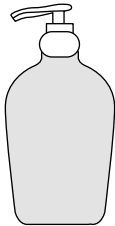
1. Which word correctly describes the containers a, b and c below?

empty	half full	almost full	full
<p>a)</p>  <p>(half full)</p>	<p>b)</p>  <p>(empty)</p>	<p>c)</p>  <p>(full)</p>	

2. Draw each of the following containers twice and then colour the first one full and the second one half full:

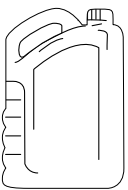
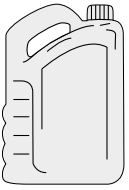
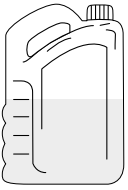
a)			
b)			

3. Draw the same bottle four times. Colour one full, one almost full, one almost empty and one empty.

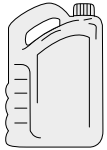
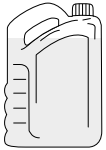
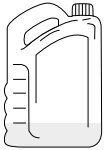
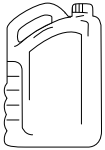
			
---	---	---	--

Homework

1. Draw this container twice and then colour the first one full and the second one half full:

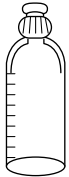
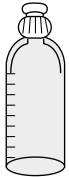
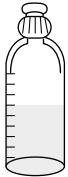
		
---	---	---

2. Cut out three pictures of containers that are full and paste them in your maths book.
(Answers may vary.)

LESSON 40: VIEWS

Teacher's notes

CAPS topics: 1.2 Count forwards and backwards, 1.16 Mental mathematics, 3.1 Position, orientation and views.

Lesson vocabulary: View, front, back, top, bottom, side, position, match.

Prior knowledge: Learners should have been taught how to:

- Follow instructions to place one object in relation to another.
- Describe the position of one object in relation to another.
- Follow directions to move around the classroom.
- Apply the language of position learnt when following directions.

Concepts:

- Match different views of the same everyday object.

Resources: Car view cards (make your own), flashcards with the following words: side, front, back, top and bottom (see *Printable Resources*). Remediation: variety of objects/toys.

DBE workbook activities relevant to this lesson:

- N/A

Assessment: Refer to the tracker for today's formal/informal oral, practical or written assessment activity.

Remediation: Give learners some objects/toys. Ask them to show you (by pointing) the front, the back, the side and the top of the toy. Discuss each view thoroughly with the learners to make sure that they understand the vocabulary. See if they can do simple drawings of the views.

Enrichment: See enrichment activity cards.

1. Mental maths

1.1 Counting (5 minutes)

- Count forwards and backwards in 1s, 2s, 5s and 10s from 0 and 80, e.g. 78, 76, 74...

1.2 Recall and strategies (10 minutes)

	Add the following:	Answer
1.	$1 + 1 + 1 = \underline{\quad}$	3
2.	$1 + 2 + 2 = \underline{\quad}$	5
3.	$3 + 1 + 0 = \underline{\quad}$	4
4.	$1 + 1 + 3 = \underline{\quad}$	5
5.	$0 + 5 + 0 = \underline{\quad}$	5

	Add the following:	Answer
6.	$2 + 1 + 1 = \underline{\quad}$	4
7.	$2 + 1 + 2 = \underline{\quad}$	5
8.	$3 + 1 + 1 = \underline{\quad}$	5
9.	$2 + 0 + 2 = \underline{\quad}$	4
10.	$1 + 3 + 1 = \underline{\quad}$	5

2. Correction/reflection on homework (15 minutes)

Reflection/remediation based on previous day's work/homework.

3. Lesson content – concept development (30 minutes)

This lesson provides learners with an opportunity to recap the concept of views. Remember to use all of the vocabulary and encourage the learners to use all of the vocabulary as well. Refer to the *Dictionary of Mathematical Terms* if you need to for definitions and examples of the vocabulary used in this lesson.

Activity 1: Whole class activity

Outdoor activity with the whole class.

- Take the learners outside where cars or taxis are parked.
- Move around one car/taxi and point out the following to the learners:
 - the front view
 - the side view
 - the back view
 - the other side view
- Ask: *What do you notice when you see the front view/side view/back view?* (Answer: We see the front windscreen/the bonnet/the doors/the boot, etc.)
- Ask: *How do you know it is the front view/the side view/the back view?* (Answer: We know that the bonnet is in the front of the car, etc.)
- Remember to keep road safety in mind.

Activity 2: Learners work in groups

Classroom activity with the groups.

- Give the learners car view cards. These can be made by cutting pictures out of magazines and pasting them on cardboard.
- Ask the learners to:
 - *Show me the picture that shows the car from the **side**.*
 - *Show me the picture that shows the car from the **front**.*
 - *Show me the picture that shows the car from the **back**.*
 - *Show me the picture that shows the car from the **top**.*
 - *Show me the picture that shows the car from the **bottom**.*

4. Classwork activity (25 minutes) (See next page)







5. Homework activity (5 minutes) (See next page)

6. Reflection on lesson

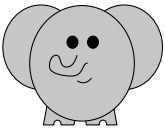
Term 3 Lesson 40: Views

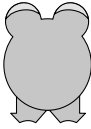
Classwork

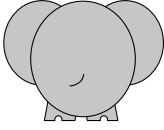
1. Find the back view of the animal and match it to the front view.

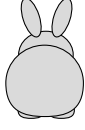



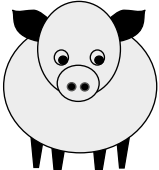
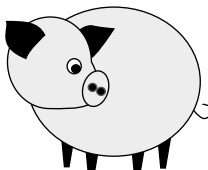
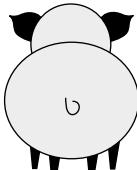
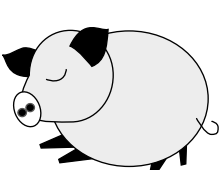



















Front		Back	
a)	 (a matches 3)	1.	
b)	 (b matches 1)	2.	
c)	 (c matches 2)	3.	
d)	 (d matches 4)	4.	

2. Colour the correct answer.

a)		b)		c)		d)	
	(front view)		front view		front view		front view
	back view		back view		(back view)		back view
	side view		(side view)		side view		(side view)

Homework

1. Circle the arrow that matches the shaded one.

a)						
b)						
c)						
d)						

PRINTABLE RESOURCES

The following printable resources are available in this section:

1. Resource sheets
2. Mental mathematics challenge cards: Bilingual version
3. Enrichment activity cards: English version
4. Enrichment activity cards: isiZulu version

Resource Sheets





This is a list of the mathematical resources that you will need this term. You need to make sure that you have them for the lessons for which they are recommended.

1. Number tracing cards – numbers 11 and 12 (Lessons 1 and 2)
2. Number tracing cards – numbers 13 and 14 (Lessons 3 and 4)
3. Number tracing cards – number 15 (Lesson 5)
4. Flard cards (Lesson 9)
5. Days of the week (Lesson 10)
6. Izinsuku zesonto (Isifundo 10)
7. Months of the year (Lesson 10)
8. Izinyanga zonyaka (Isifundo 10)
9. Number lines (Lessons 11 and 13)
10. Calendar (Lesson 20)
11. Tally table grid (Lesson 20)
12. Blank pictograph (Lesson 21)
13. Money cut-outs – coins (Lessons 22, 23 and 24)
14. Money cut-outs – notes (Lessons 22, 23 and 24)
15. 1–80 number board (Lesson 27, 28 and 29)
16. Number cards – multiples of 5 (Lesson 28)
17. Views flashcards (Lesson 40)
18. Ukubheka amafleshi-khadi (Isifundo 40)











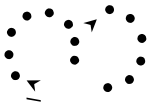

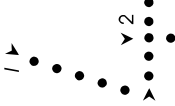



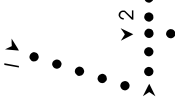

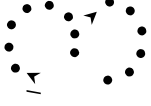

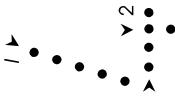

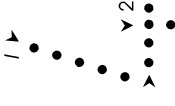

Resources for each day of teaching

There are also other resources such as informal resources (old magazines, pieces of string, scrap paper, etc.) that you may need in certain lessons. You should have a careful look at the list of resources needed for each lesson; this list is given in the lesson plan each day. Prepare yourself, so that you have the necessary resources for the lessons on a daily basis.

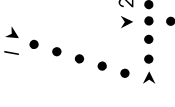



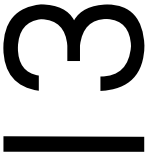
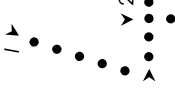

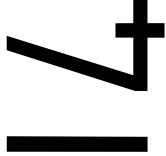





1. Number tracing cards (Lessons 1 and 2)

2. Number tracing cards (Lessons 3 and 4)

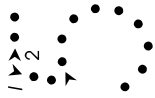
3. Number tracing cards (Lesson 5)

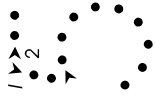
4. Flard cards (Lesson 9)

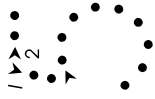
6	60
7	70
8	80
9	90

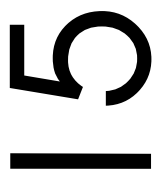
1	10
2	20
3	30
4	40
5	50

5. Days of the week (Lesson 10)

Monday

Tuesday

Wednesday

Thursday

Friday

Saturday

Sunday

uMsombuluko

uLwesibili

uLwesithathu

uLwesine

uLwesihlanu

uMgqibelo

iSonto

7. Months of the year (Lesson 10)

January

February

March

April

May

June

July

August

September

October

November

December

8. Izinyanga zonyaka (Isifundo 10)

uMasingana

uNhlolanja

uNdasa

uMbasa

uNhlaba

uNhlanguvana

uNtulikazi

uNcwaba

uMandulo

uMfumfu







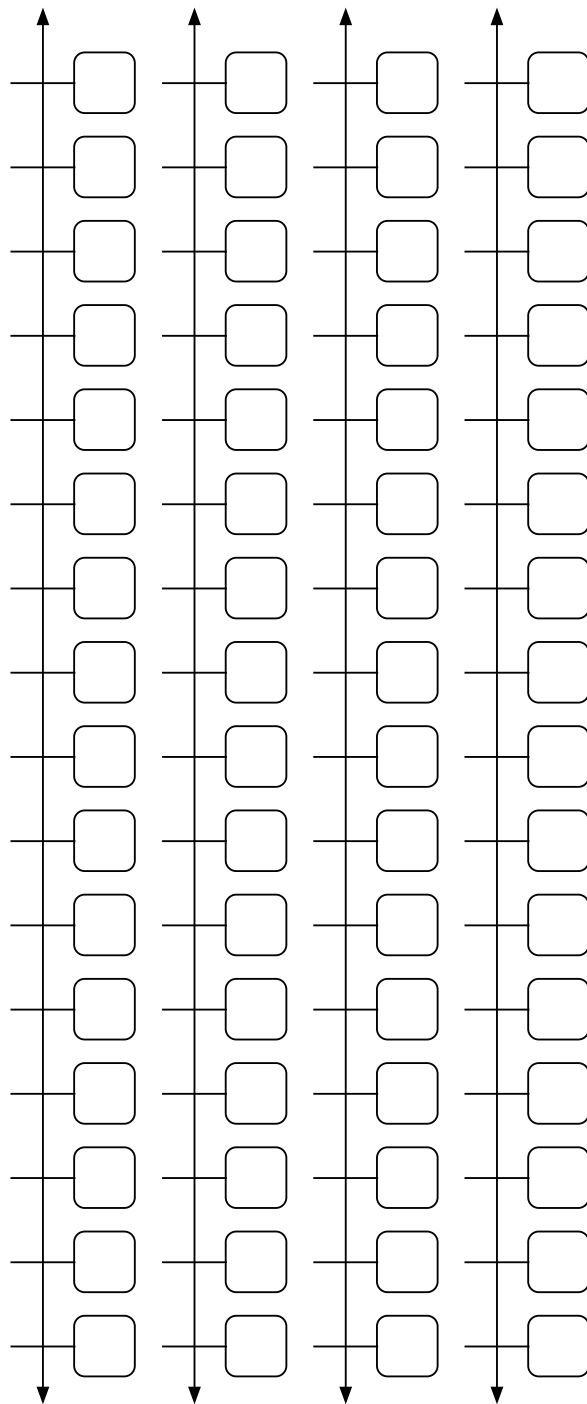
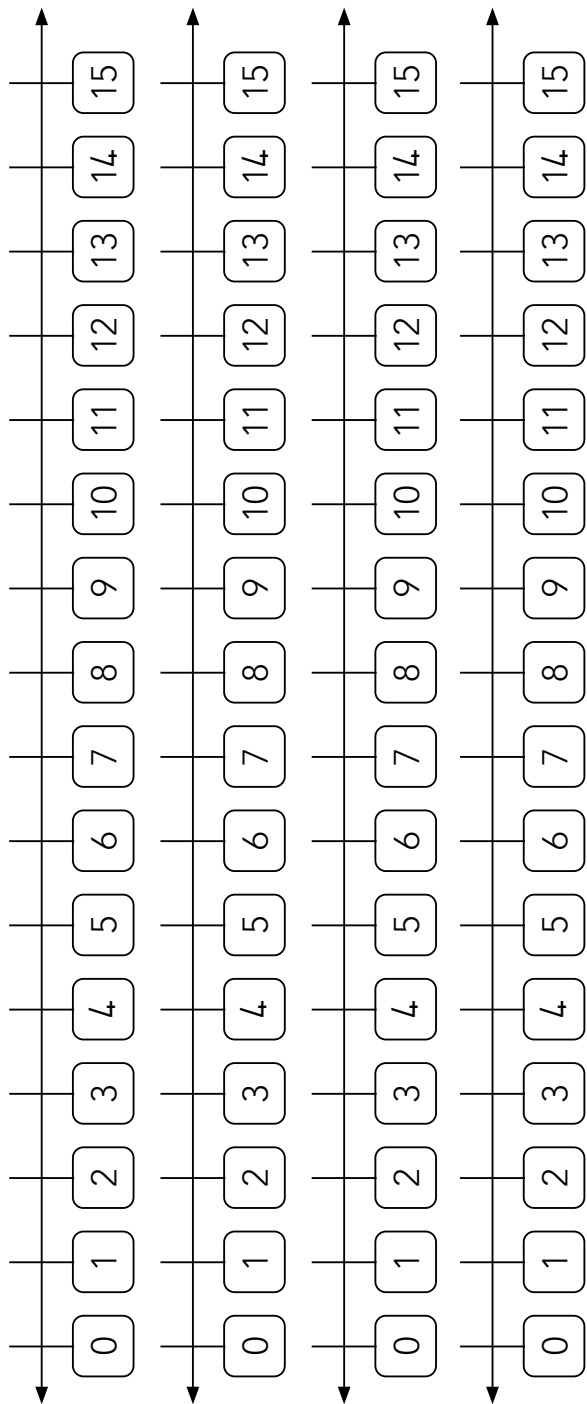



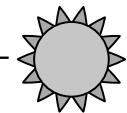

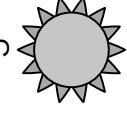

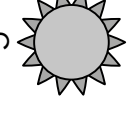
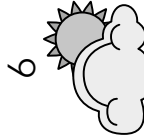
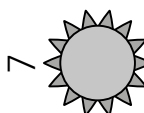
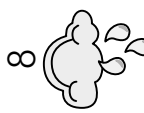
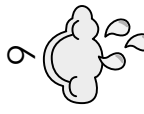
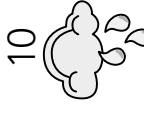
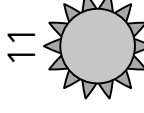
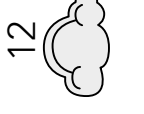
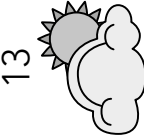
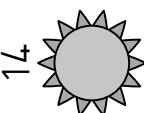
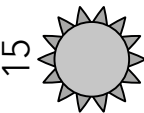
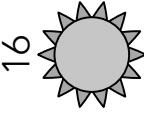
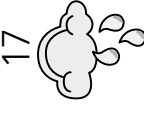
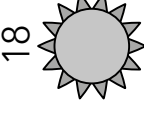

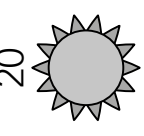
uLwezi

uZibandlela

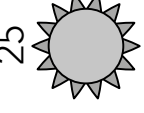

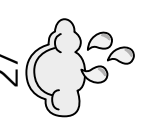
9. Number lines (Lessons 11 and 13)

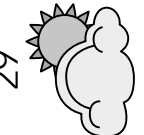
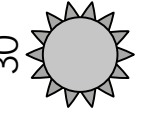

10. Calendar (Lesson 20)

January						
Sunday	Monday	Tuesday	Wednesday	Thursday	Friday	Saturday
		1 	2 	3 	4 	5 
6 	7 	8 	9 	10 	11 	12 
13 	14 	15 	16 	17 	18 	19 
20 	21 	22 	23 	24 	25 	26 
27 	28 	29 	30 	31 		

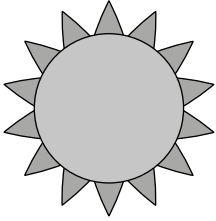
11. Tally table grid (Lesson 20)

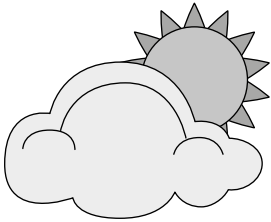
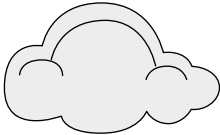
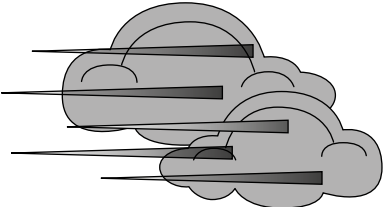
12. Blank pictograph (Lesson 21)

Birthdays during the first term							
7							
6							
5							
4							
3							
2							
1							
	January	February	March	April			

13. Money cut-outs – coins (Lessons 22, 23 and 24)



14. Money cut-outs – notes (Lessons 22, 23 and 24)



15. 1–80 number board (Lessons 27, 28 and 31)

1	2	3	4	5	6	7	8	9	10
11	12	13	14	15	16	17	18	19	20
21	22	23	24	25	26	27	28	29	30
31	32	33	34	35	36	37	38	39	40
41	42	43	44	45	46	47	48	49	50
51	52	53	54	55	56	57	58	59	60
61	62	63	64	65	66	67	68	69	70
71	72	73	74	75	76	77	78	79	80

16. Number cards – multiples of 5 (Lessons 27 and 28)

5	10
15	20
25	30
35	40
45	50

17. Views flashcards (Lesson 40)

side

front

back

top

bottom

18. Ukubheka amafleshi-khadi (Isifundo 40)

uhlangothi

ngaphambili

ngemuva

phezulu

ingaphansi

Mental Mathematics Challenge Cards: Bilingual version

Each term there will be a set of eight mental mathematics challenge cards. If you make them into cards and collect them over the course of the year, you will have a set of one card per teaching week for a year.

Use of the mental mathematics challenge cards

Once a week learners should do mental mathematics in written form, so that there is some record of your daily mental mathematics activities. You can use the **mental mathematics challenge cards** for this purpose.

Learners should not use concrete material to work out the answers in mental mathematics. If learners need to, let them use their fingers as a concrete aid during mental mathematics, but make a note of who they are and then spend time with them during remediation to help them with the basic number and operation skills. Mental mathematics skills improve hugely from Grade 1 to Grade 3. In Grade 1 learners might only manage five questions, especially when they have to write the answers, but by Grade 3 learners should manage ten questions with written answers easily.

Maths Challenge Card 1

Order from smallest to biggest.

Ikhadi Lenselelo Yezibalo 1

Landelanisa usuke kokuncane kunakho konke uye kokukhulu kunakho konke

1. 10, 3, 8
2. 2, 12, 4
3. 7, 15, 4
4. 13, 9, 1
5. 14, 0, 5
6. 13, 3, 1
7. 0, 15, 8
8. 2, 11, 7
9. 14, 1, 13
10. 10, 11, 0

Maths Challenge Card 2

2 more than

Ikhadi Lenselelo Yezibalo 2

Kukhulu ngoku-2 kunalokhu

1. 6
2. 8
3. 11
4. 4
5. 10
6. 5
7. 12
8. 7
9. 9
10. 13

Maths Challenge Card 3

1 less than

Ikhadi Lenselelo Yezibalo 3

Kuncane ngoku-1 kunalokhu

1. 15
2. 8
3. 12
4. 6
5. 10
6. 13
7. 1
8. 14
9. 7
10. 9

Maths Challenge Card 4

Doubling

Ikhadi Lenselelo Yezibalo 4

Ukuphinda kabili

1. 2
2. 5
3. 7
4. 1
5. 4
6. 6
7. 3
8. $2 + 2 + 1 =$
9. $4 + 4 + 1 =$
10. $3 + 3 + 1 =$

Maths Challenge Card 1: Answers

Order from smallest to biggest.

Ikhadi Lenselelo Yezibalo 1: Izimpendulo

Landelanisa usuke kokuncane kunakho konke uye kokukhulu kunakho konke

1. 3, 8, 10
2. 2, 4, 12
3. 4, 7, 15
4. 1, 9, 13
5. 0, 5, 14
6. 1, 3, 13
7. 0, 8, 15
8. 2, 7, 11
9. 1, 13, 14
10. 0, 10, 11

Maths Challenge Card 2: Answers

2 more than

Ikhadi Lenselelo Yezibalo 2: Izimpendulo

Kukhulu ngoku-2 kunalokhu

1. 8
2. 10
3. 13
4. 6
5. 12
6. 7
7. 14
8. 9
9. 11
10. 15

Maths Challenge Card 3: Answers

1 less than

Ikhadi Lenselelo Yezibalo 3: Izimpendulo

Kuncane ngoku-1 kunalokhu

1. 14
2. 7
3. 11
4. 5
5. 9
6. 12
7. 0
8. 13
9. 6
10. 8

Maths Challenge Card 4: Answers

Doubling

Ikhadi Lenselelo Yezibalo 4: Izimpendulo

Ukuphinda kabili

1. 4
2. 10
3. 14
4. 2
5. 8
6. 12
7. 6
8. 5
9. 9
10. 7

Maths Challenge Card 5

Halving

Ikhadi Lenselelo Yezibalo 5

Ukuhhafula

1. 8
2. 12
3. 10
4. 14
5. 2
6. 3
7. 4
8. 5
9. 6
10. 7

Maths Challenge Card 6

Add

Ikhadi Lenselelo Yezibalo 6

Hlanganisa

1. $2 + 3 =$
2. $1 + 1 =$
3. $2 + 1 =$
4. $3 + 1 =$
5. $0 + 4 =$
6. $1 + 4 =$
7. $3 + 0 =$
8. $2 + 2 =$
9. $5 + 0 =$
10. $2 + 0 =$

Maths Challenge Card 7

Subtract

Ikhadi Lenselelo Yezibalo 7

Susa

1. $5 - 1 =$
2. $3 - 3 =$
3. $4 - 2 =$
4. $5 - 2 =$
5. $4 - 1 =$
6. $2 - 1 =$
7. $5 - 4 =$
8. $3 - 1 =$
9. $5 - 3 =$
10. $4 - 0 =$

Maths Challenge Card 8

Add and subtract 0–5

Ikhadi Lenselelo Yezibalo 8

Hlanganisa ususe 0–5

1. $2 + 2 =$
2. $5 - 5 =$
3. $3 + 1 =$
4. $5 - 2 =$
5. $1 + 2 =$
6. $2 - 2 =$
7. $4 + 0 =$
8. $4 - 3 =$
9. $3 + 2 =$
10. $5 - 4 =$

Maths Challenge Card 5: Answers

Halving

Ikhadi Lenselelo Yezibalo 5: Izimpendulo

Ukuhhafula

1. 4
2. 6
3. 5
4. 7
5. 1
6. 1 and 1 left over / Ku-1 nensalela e-1
7. 2
8. 2 and 1 left over / Ku-2 nensalela e-1
9. 3
10. 3 and 1 left over / Ku-3 nensalela e-1

Maths Challenge Card 6: Answers

Add

Ikhadi Lenselelo Yezibalo 6: Izimpendulo

Hlanganisa

1. 5
2. 2
3. 3
4. 4
5. 4
6. 5
7. 3
8. 4
9. 5
10. 2

Maths Challenge Card 7: Answers

Subtract

Ikhadi Lenselelo Yezibalo 7: Izimpendulo

Susa

1. 4
2. 0
3. 2
4. 3
5. 3
6. 1
7. 1
8. 2
9. 2
10. 4

Maths Challenge Card 8: Answers

Add and subtract 0–5

Ikhadi Lenselelo Yezibalo 8: Izimpendulo

Hlanganisa ususe 0–5

1. 4
2. 0
3. 4
4. 3
5. 3
6. 0
7. 4
8. 1
9. 5
10. 1

Enrichment Activity Cards: English version

Each term a set of new enrichment cards will be provided. You should retain this set, as they will not be reproduced each term.

Use of the enrichment activity cards

Optional as required.

These cards include activities that you can use for enrichment opportunities for learners who have completed the lesson activities ahead of the rest of the class. Learners should work on these cards independently or with their peers who have also completed the classwork. You may need to explain some of the activities to the learners who use them. You should remind them to ask you questions about any of the enrichment activities that they are doing, so that you can guide them as necessary.

You should photocopy the enrichment cards, paste them onto cardboard and laminate them (if possible), so that they can be used as a resource, not only this year but in the future as well.

Put the laminated cardboard cards into a box in a set place in your classroom, so that learners know where to find them. These cards are for all learners and do not have to be used in a particular order. Learners should keep a record of the cards that they have done, so that they continue to choose a new card each time they go to the box. Learners must be taught to replace the cards in numeric order in the box, so that everyone who looks for cards can easily find the one they want to use.

Enrichment Activity 3.1

Who am I?

I am 4 more than 3 and one less than 8.

I am next to number 10. I have 1 ten and 1 unit.

Enrichment Activity 3.2

Who has the most money?

- Busi has: two 10c coins, three 5c coins and one 50c coin.
- Pete has: one R1 coin, two 5c coins and one 20c coin.
- Nicole has: five 10c coins, five 20c coins and two 5c coins.

_____ has the most money.

Enrichment Activity 3.3

Spot the mistake.

Use your pencil to colour the numbers and shape which are wrong.

2	4	7	8	10	12	13	16
---	---	---	---	----	----	----	----

5	10	15	16	20	21	25
---	----	----	----	----	----	----

10	9	8	3	7	7	6	5	7
----	---	---	---	---	---	---	---	---

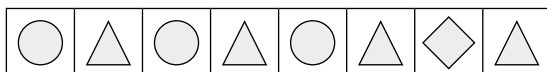

Enrichment Activity 3.4

Find the numbers.

Find and colour all the pairs of blocks where two numbers that are next to, or underneath one another, will give you 10.

1	9	12	7
5	4	6	3
5	10	7	9
3	0	1	10
8	2	7	3

Enrichment Activity 3.1: Answers

Who am I?

I am 4 more than 3 and one less than 8.

7

I am next to number 10. I have 1 ten and 1 unit.

11

Enrichment Activity 3.2: Answers

Who has the most money?

- Busi has: two 10c coins, three 5c coins and one 50c coin.
- Pete has: one R1 coin, two 5c coins and one 20c coin.
- Nicole has: five 10c coins, five 20c coins and two 5c coins.

Nicole has the most money.

Enrichment Activity 3.3: Answers

Spot the mistake.

Use your pencil to colour the numbers and shape which are wrong.

2	4	7	8	10	12	13	16
---	---	---	---	----	----	----	----

5	10	15	16	20	21	25
---	----	----	----	----	----	----

10	9	8	3	7	7	6	5	1
----	---	---	---	---	---	---	---	---

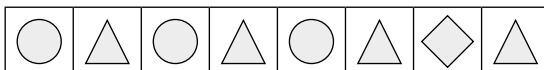

Enrichment Activity 3.4: Answers

Find the numbers.

Find and colour all the pairs of blocks where two numbers that are next to, or underneath one another, will give you 10.

1	9	12	7
5	4	6	3
5	10	7	9
3	0	1	10
8	2	7	3

Enrichment Activity 3.5

Shapes

triangles – blue

rectangles – red

circles – yellow

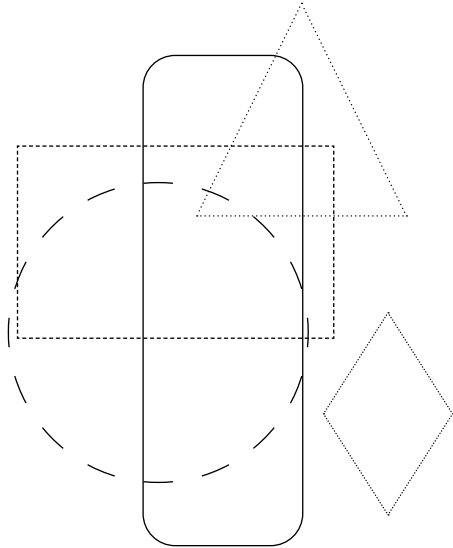

Enrichment Activity 3.6

Find the numbers

Find and colour all the pairs of blocks where two numbers that are next to, or underneath one another, will give you 15.

1	11	4	9
15	6	14	2
0	5	1	2
2	8	7	3
6	9	4	12

Enrichment Activity 3.7

Add one more set of shapes to extend the pattern.

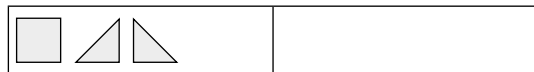
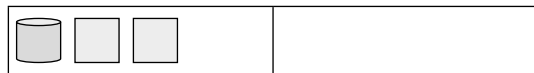

Enrichment Activity 3.8

Counting

How many are there?

threes _____

circles _____

fives _____

squares _____

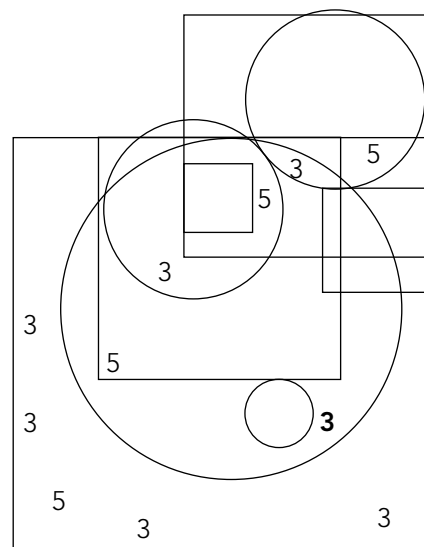

Enrichment Activity 3.5: Answers

Shapes

triangles – blue

rectangles – red

circles – yellow

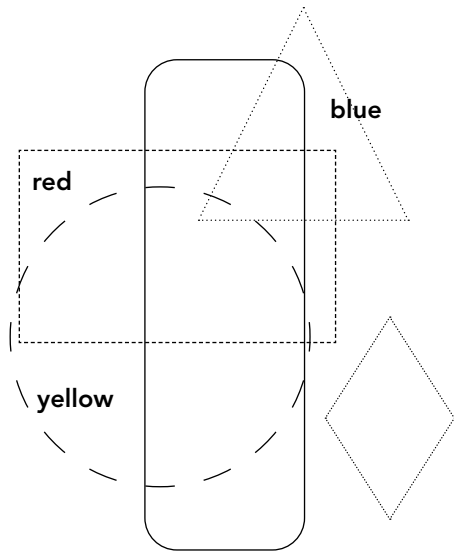

Enrichment Activity 3.6: Answers

Find the numbers

Find and colour all the pairs of blocks where two numbers that are next to, or underneath one another, will give you 15.

1	11	4	9
15	6	14	2
0	5	1	2
2	8	7	3
6	9	4	12

Enrichment Activity 3.7: Answers

Add one more set of shapes to extend the pattern.

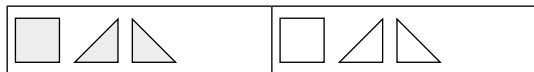
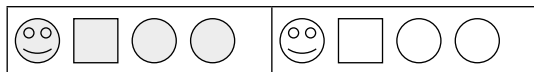

Enrichment Activity 3.8: Answers

Counting

How many are there?

threes **7** circles **4**

fives **4** squares **4**

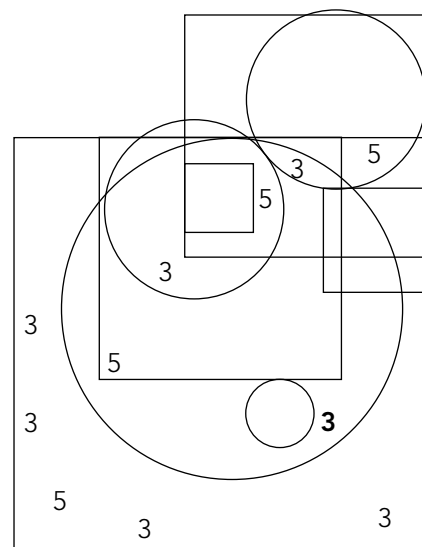

Enrichment Activity 3.9

What is my number?

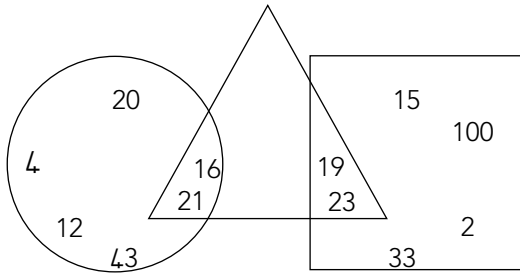

1. This number is in the circle. It is 1 more than 11. _____
2. This number is in the square. It is $13 + 2$. _____
3. This number is in the triangle. It is the number that comes before 20. _____

Enrichment Activity 3.10

Playing darts

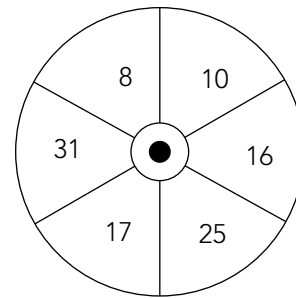

1. What is the highest score using 1 dart?

2. Ben's score is 18. Which two numbers did he get? _____, _____.
3. Siphon's score is 20. Two darts hit the same number. Which number did he get?

Enrichment Activity 3.11

How many squares?

A				
B				
C				
D				

How many squares are there in:

Row A? _____

Row B? _____

Row D? _____

Add the number of blocks in rows C and B

Enrichment Activity 3.12

Number 12

$$\text{_____} + 1 = 12$$

$$\text{_____} + 3 = 12$$

$$\text{_____} + 5 = 12$$

$$\text{_____} + 7 = 12$$

$$\text{_____} + 9 = 12$$

$$\text{_____} + 12 = 12$$

Enrichment Activity 3.9: Answers

What is my number?

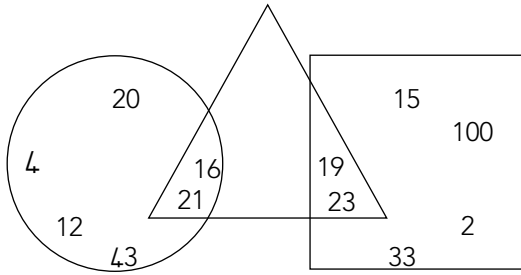

1. This number is in the circle. It is 1 more than 11. **12**
2. This number is in the square.
It is $13 + 2$. **15**
3. This number is in the triangle. It is the number that comes before 20. **19**

Enrichment Activity 3.10: Answers

Playing darts

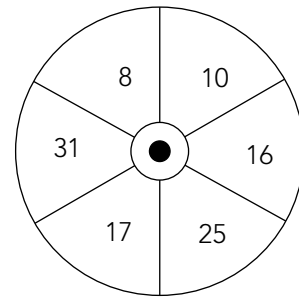

1. What is the highest score using 1 dart?
31
2. Ben's score is 18. Which two numbers did he get? **8, 10.**
3. Siphon's score is 20. Two darts hit the same number. Which number did he get?
10

Enrichment Activity 3.11: Answers

How many squares?

A				
B				
C				
D				

How many squares are there in:

Row A? **4**

Row B? **4**

Row D? **4**

Add the number of blocks in rows C and B **8**

Enrichment Activity 3.12: Answers

Number 12

$$11 + 1 = 12$$

$$9 + 3 = 12$$

$$7 + 5 = 12$$

$$5 + 7 = 12$$

$$3 + 9 = 12$$

$$0 + 12 = 12$$

Enrichment Activity 3.13

Cell phone games



Which letters do you see if you look at these numbers?

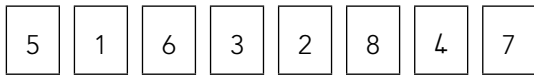

Enrichment Activity 3.14

What is the word?



Look at the keys and see what colour these numbers spell:

3 2 5 _____

You do this with your eyes:

4 2 2 _____

A boy's name:

6 3 2 5 _____

Enrichment Activity 3.15

Add



Add the numbers that are on the same button as these letters:

$$D + F + W = \underline{\quad}$$

$$X + E + R = \underline{\quad}$$

$$F + F + Z = \underline{\quad}$$

$$C + F + R = \underline{\quad}$$

Enrichment Activity 3.16

Some more adding



Add the numbers that make the word **RED**.

Add the numbers that make the word **SEE**.

Add the numbers that make the word **FRED**.

Enrichment Activity 3.13: Answers

Cell phone games



Which letters do you see if you look at these numbers?

5	1	6	3	2	8	4	7
D	W	F	R	E	X	S	Z

Enrichment Activity 3.14: Answers

What is the word?



Look at the keys and see what colour these numbers spell:

3 2 5 **RED**

You do this with your eyes:

4 2 2 **SEE**

A boy's name:

6 3 2 5 **FRED**

Enrichment Activity 3.15: Answers

Add



Add the numbers that are on the same button as these letters:

$$D + F + W = 12$$

$$X + E + R = 13$$

$$F + F + Z = 19$$

$$C + F + R = 18$$

Enrichment Activity 3.16: Answers

Some more adding



Add the numbers that make the word RED.

10

Add the numbers that make the word SEE.

8

Add the numbers that make the word FRED.

16

Enrichment Activity 3.17

True or false?

Make a tick (✓) if the answer is correct.

Make a cross (✗) if the answer is wrong.

$4 + 13 = 20$

$5 + 5 + 5 = 15$

$6 + 7 + 3 = 17$

$20 - 5 - 6 = 8$

$17 - 5 - 3 = 9$

$18 - 10 - 3 = 9$

Enrichment Activity 3.18

Some more true or false

Make a tick (✓) if the answer is correct.

Make a cross (✗) if the answer is wrong.

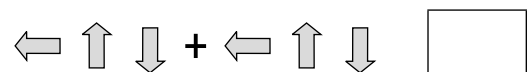
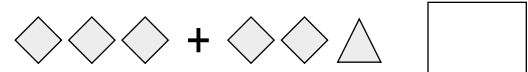

Enrichment Activity 3.19

How many can you find?

When you count in 2s from 2 to 20?

When you count in 5s from 5 to 50?

When you count in 1s from 11 to 31?

When you count in tens from 0 – 100?

Enrichment Activity 3.20

How many small squares?

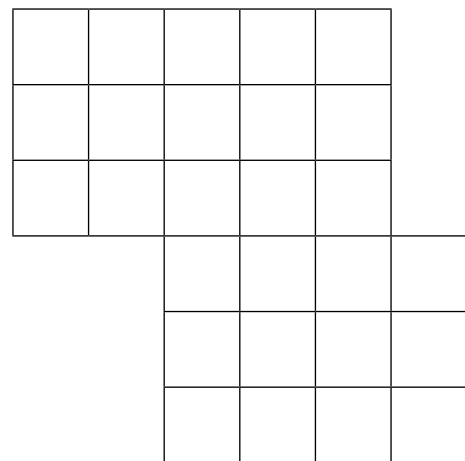

_____?

Enrichment Activity 3.17: Answers

True or false?

Make a tick (✓) if the answer is correct.

Make a cross (✗) if the answer is wrong.

$4 + 13 = 20$

✗

$5 + 5 + 5 = 15$

✓

$6 + 7 + 3 = 17$

✗

$20 - 5 - 6 = 8$

✗

$17 - 5 - 3 = 9$

✓

$18 - 10 - 3 = 9$

✗

Enrichment Activity 3.18: Answers

Some more true or false

Make a tick (✓) if the answer is correct.

Make a cross (✗) if the answer is wrong.

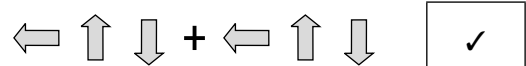
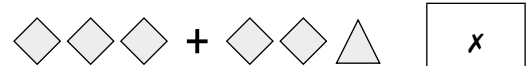

Enrichment Activity 3.19: Answers

How many can you find?

When you count in 2s from 2 to 20?

10

When you count in 5s from 5 to 50?

10

When you count in 1s from 11 to 31?

21

When you count in tens from 0 – 100?

10

Enrichment Activity 3.20: Answers

How many small squares?

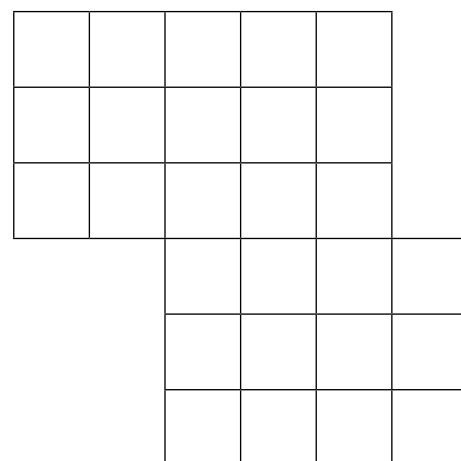

27 squares

Enrichment Activity 3.21

Find your way

Start at the first face and find a way to the last face by going past only the happy faces. Don't go through any sad faces.

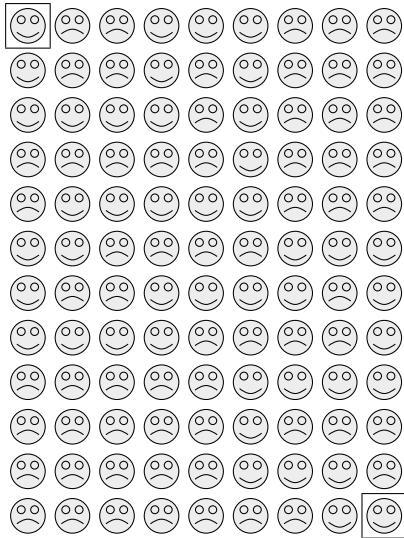

Enrichment Activity 3.22

Where is the number name?

Colour it in the letter grid.

s	o	n	e	t	o	w
f	i	v	e	s	e	v
n	r	t	h	r	e	e
i	t	e	n	s	i	x
n	w	e	i	g	h	t
e	o	f	o	u	r	b

- 1 10
- 3 9
- 2 4
- 5 8

Enrichment Activity 3.23

Who are my friends?

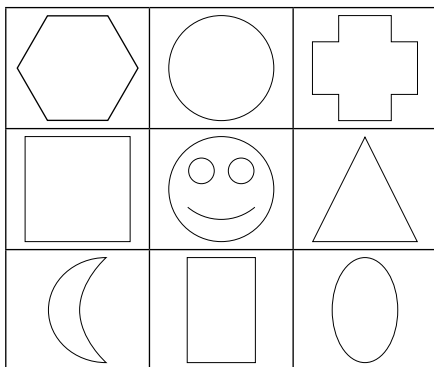

Colour the shapes:

- The cross orange.
- The triangle pink.
- The circle blue.
- The rectangles green.
- The face yellow.

Enrichment Activity 3.24

Find the shapes

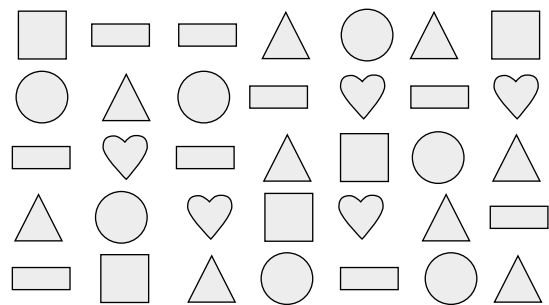

How many?:

- triangles: _____
- rectangles: _____
- circles: _____
- squares: _____

Enrichment Activity 3.21: Answers

Find your way:

Start at the first face and find a way to the last face by going past only the happy faces. Don't go through any sad faces.

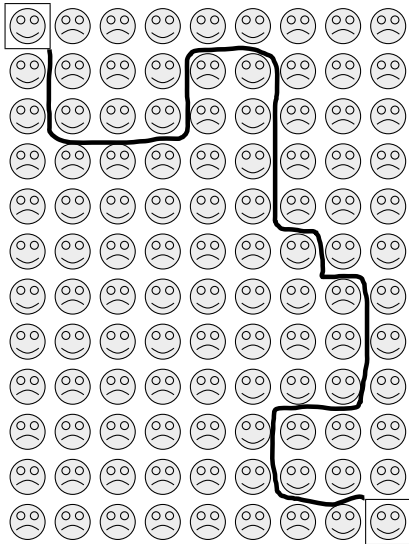

Enrichment Activity 3.22: Answers

Where is the number name?

Colour it in the letter grid.

s	o	n	e	t	o	w
f	i	v	e	s	e	v
n	r	t	h	r	e	e
i	t	e	n	s	i	x
n	w	e	i	g	h	t
e	o	f	o	u	r	b

- 1 10
- 3 9
- 2 4
- 5 8

Enrichment Activity 3.23: Answers

Who are my friends?

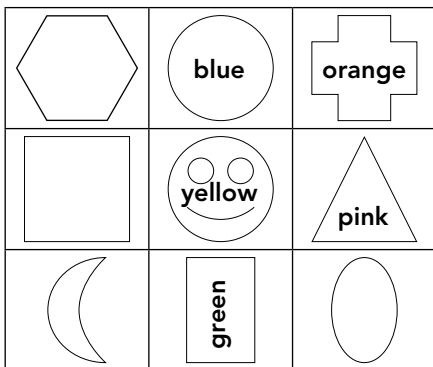

Colour the shapes:

- The cross orange.
- The triangle pink.
- The circle blue.
- The rectangles green.
- The face yellow.

Enrichment Activity 3.24: Answers

Find the shapes

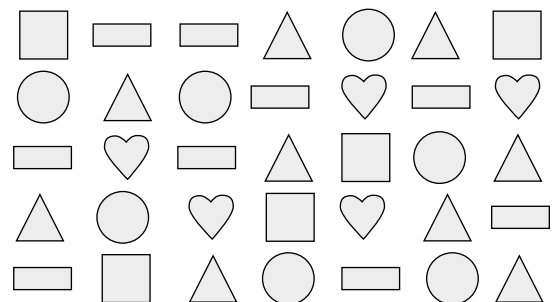

How many?:

- triangles: **9**
- rectangles: **9**
- circles: **7**
- squares: **5**

Enrichment Activity 3.25





Complete the Sudoku

	2	3	4
3	4	1	
2	1	4	
	3	2	1





Enrichment Activity 3.26

Money - Order the coins





Choose the coin that has the most value:

1. 	2. 	3. 	4. 

Choose the coin that has the least value:

1. 	2. 	3. 	4. 

Choose the coins that you will use to buy a sweet for 35c:

1. 	2. 	3. 	4. 

Enrichment Activity 3.27

What can I buy?

You have R2,00.

Can you buy three cupcakes?

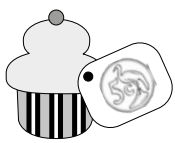

You have R5,00.

Can you buy three balls?



Enrichment Activity 3.28

Complete the Sudoku

2	1	4	3
4			1
1			4
3	4	1	2

Enrichment Activity 3.25: Answers





Complete the Sudoku

1	2	3	4
3	4	1	2
2	1	4	3
4	3	2	1





Enrichment Activity 3.26: Answers

Money - Order the coins





Choose the coin that has the most value:

1. 	2. 	3. 	4. 

Choose the coin that has the least value:

1. 	2. 	3. 	4. 

Choose the coins that you will use to buy a sweet for 35c:

1. 	2. 	3. 	4. 

Enrichment Activity 3.27: Answers

What can I buy?

You have R2,00.

Can you buy three cupcakes?



yes

You have R5,00.

Can you buy three balls?



no

Enrichment Activity 3.28: Answers

Complete the Sudoku

2	1	4	3
4	3	2	1
1	2	3	4
3	4	1	2

Enrichment Activity 3.29

Jumbled sums

Use the numbers in the boxes to make a sum.

$\square + \square = \square$
 $\square + \square = \square$
 $\square + \square + \square = \square$

Enrichment Activity 3.30

Three numbers

Write 3 numbers in the blocks that will add up to the end number.

			15
			19
			26
			21

Enrichment Activity 3.31

Value

What is the value of each cylinder if a rectangle is 4, a circle is 3, a triangle is 1 and a diamond is 10? Write the answer in the box.

\square
 \square
 \square

Enrichment Activity 3.32

Colour to show the answer

Colour the numbers that will add up to the first number in the row of blocks.

10	3	5	2	9	7	4	0
20	8	6	10	4	3	5	2
26	1	9	7	3	0	5	1

Enrichment Activity 3.29: Answers

Jumbled sums

Use the numbers in the boxes to make a sum.

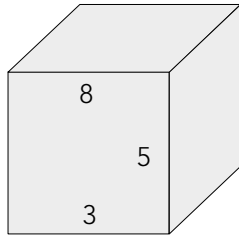

$$\boxed{5} + \boxed{3} = \boxed{8}$$

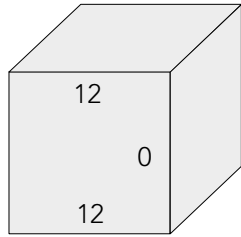

$$\boxed{12} + \boxed{0} = \boxed{12}$$

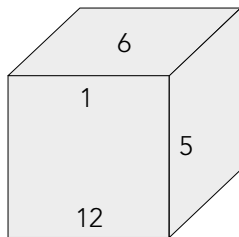

$$\boxed{5} + \boxed{1} + \boxed{6} = \boxed{12}$$

Enrichment Activity 3.30: Answers

Three numbers

Write 3 numbers in the blocks that will add up to the end number.

1	1	13	15
---	---	----	----

5	5	9	19
---	---	---	----

10	10	6	26
----	----	---	----

10	11	0	21
----	----	---	----

Enrichment Activity 3.31: Answers

Value

What is the value of each cylinder if a rectangle is 4, a circle is 3, a triangle is 1 and a diamond is 10? Write the answer in the box.

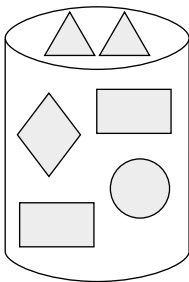

23

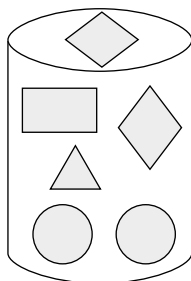

31

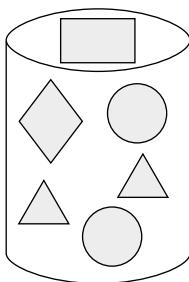

22

Enrichment Activity 3.32: Answers

Colour to show the answer

Colour the numbers that will add up to the first number in the row of blocks.

10	3	5	2	9	7	4	0
10	3	5	2	9	7	4	0

20	8	6	10	4	3	5	2
20	8	6	10	4	3	5	2

26	1	9	7	3	0	5	1
----	---	---	---	---	---	---	---

Enrichment Activity Cards: isiZulu version

Each term a set of new enrichment cards will be provided. You should retain this set, as they will not be reproduced each term.

Use of the enrichment activity cards

Optional as required.

These cards include activities that you can use for enrichment opportunities for learners who have completed the lesson activities ahead of the rest of the class. Learners should work on these cards independently or with their peers who have also completed the classwork. You may need to explain some of the activities to the learners who use them. You should remind them to ask you questions about any of the enrichment activities that they are doing, so that you can guide them as necessary.

You should photocopy the enrichment cards, paste them onto cardboard and laminate them (if possible), so that they can be used as a resource, not only this year but in the future as well.

Put the cardboard laminated cards into a box in a set place in your classroom, so that learners know where to find them. These cards are for all learners and do not have to be used in a particular order. Learners should keep a record of the cards that they have done, so that they continue to choose a new card each time they go to the box. Learners must be taught to replace the cards in numeric order in the box, so that everyone who looks for cards can easily find the one they want to use.

Umsebenzi Wokubakhulisa 3.1

Ngingubani mina?

Ngingaphezulu ngoku-4 koku-3
kanti ngingaphansi koku-8 ngoku-1.

Ngiseduze kwe-10. Ngineshumi
elilodwa nomuvo owodwa.

Umsebenzi Wokubakhulisa 3.2

Ngubani onemali eningi kunabanye?

- UBusi unale mali: unama-10c amabili, ama-5c amathathu kanye nama-5c.
- UPete unale mali: une-R1 eliwuhlweza, ama-5c amabili kanye nama-20c.
- UNicole unale mali ama-10c amahlanu, ama-20c amahlanu kanye nama-5c amabili.

_____ unemali eningi kunabanye.

Umsebenzi Wokubakhulisa 3.3

Thola iphutha.

Sebenzisa ipensela lakho ukufaka umbala ezinombolweni kanye nasezimeni ezingafanele.

2	4	7	8	10	12	13	16
---	---	---	---	----	----	----	----

5	10	15	16	20	21	25
---	----	----	----	----	----	----

10	9	8	3	7	7	6	5	7
----	---	---	---	---	---	---	---	---

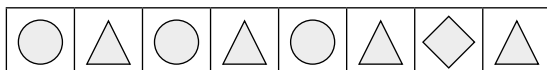

Umsebenzi Wokubakhulisa 3.4

Thola izinombolo.

Thola bese ufaka, umbala wonke amapheya amabhulokhi anezinombolo ezimbili ezisondelene, noma lapho enye ingezansi kwenye khona, ezakha ama-10.

1	9	12	7
5	4	6	3
5	10	7	9
3	0	1	10
8	2	7	3

Umsebenzi Wokubakhulisa 3.1: Izimpendulo

Who am I?

Ngingaphezulu ngoku-4 koku-3
kanti ngingaphansi koku-8 ngoku-1.

7

Ngiseduze kwe-10. Ngineshumi
elilodwa nomuvo owodwa.

11

Umsebenzi Wokubakhulisa 3.2: Izimpendulo

Ngubani onemali eningi kunabanye?

- UBusi unale mali: unama-10c amabili, ama-5c amathathu kanye nama-5c.
- UPete unale mali: une-R1 eliwuhlweza, ama-5c amabili kanye nama-20c.
- UNicole unale mali ama-10c amahlanu, ama-20c amahlanu kanye nama-5c amabili.

UNicole unemali eningi kunabanye.

Umsebenzi Wokubakhulisa 3.3: Izimpendulo

Thola iphutha.

Sebenzisa ipensela lakho ukufaka umbala ezinombolweni kanye nasezimeni ezingafanele.

2	4	7	8	10	12	13	16
---	---	---	---	----	----	----	----

5	10	15	16	20	21	25
---	----	----	----	----	----	----

10	9	8	3	7	7	6	5	1
----	---	---	---	---	---	---	---	---



Umsebenzi Wokubakhulisa 3.4: Izimpendulo

Thola izinombolo.

Thola bese ufaka, umbala wonke amapheya amabhulokhi anezinombolo ezimbili ezisondelene, noma lapho enye ingezansi kwenye khona, ezakha ama-10.

1	9	12	7
5	4	6	3
5	10	7	9
3	0	1	10
8	2	7	3

Umsebenzi Wokubakhulisa 3.5

Izimo

onxantathu – basasibhakabhaka

onxande – kubomvu

iziyingi – kuphuzi

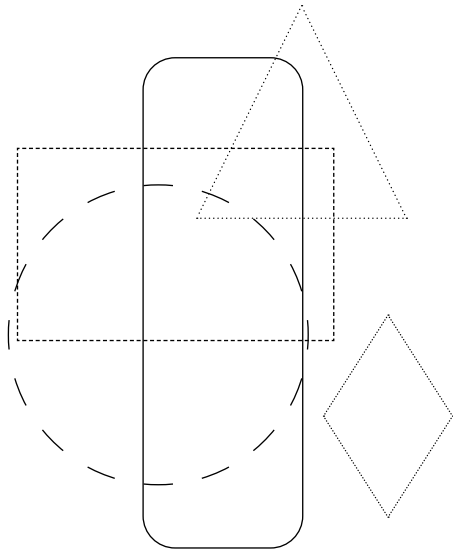

Umsebenzi Wokubakhulisa 3.6

Thola izinombolo

Thola bese ufaka, umbala wonke amapheya amabhulokhi anezinombolo ezimbili ezisondelene, noma lapho enye ingezansi kwenye khona, ezakha ama-15.

1	11	4	9
15	6	14	2
0	5	1	2
2	8	7	3
6	9	4	12

Umsebenzi Wokubakhulisa 3.7

Faka ezinye izimo ukuze kweluleke iphethini.

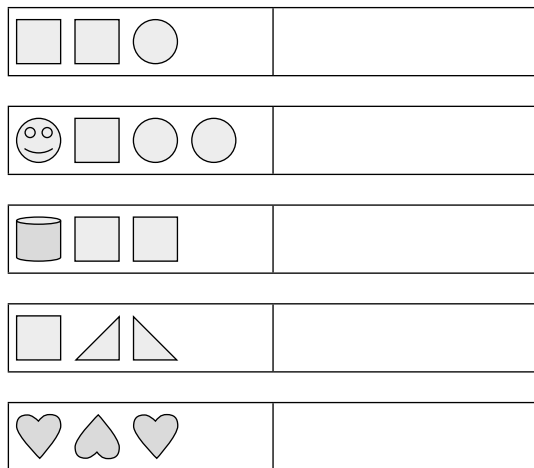

Umsebenzi Wokubakhulisa 3.8

Ukubala

Kungaki?

okuthathu _____ iziyingi _____

ukuhlanu _____ izikwele _____

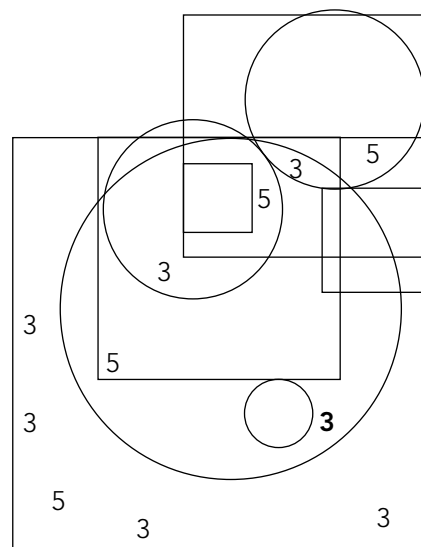

Umsebenzi Wokubakhulisa 3.5: Izimpendulo

Izimo

onxantathu – basasibhakabhaka

onxande – kubomvu

iziyingi – kuphuzi

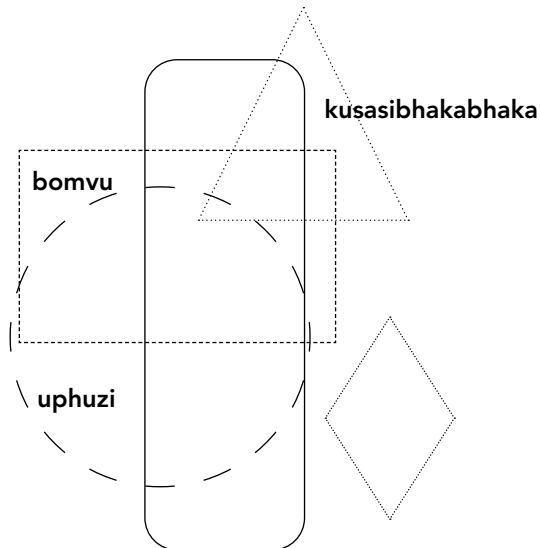

Umsebenzi Wokubakhulisa 3.6: Izimpendulo

Thola izinombolo

Thola bese ufaka, umbala wonke amapheya amabhulokhi anezinombolo ezimbili ezisondelene, noma lapho enye ingezansi kwenye khona, ezakha ama-15.

1	11	4	9
15	6	14	2
0	5	1	2
2	8	7	3
6	9	4	12

Umsebenzi Wokubakhulisa 3.7: Izimpendulo

Faka ezinye izimo ukuze kweluleke iphethini.

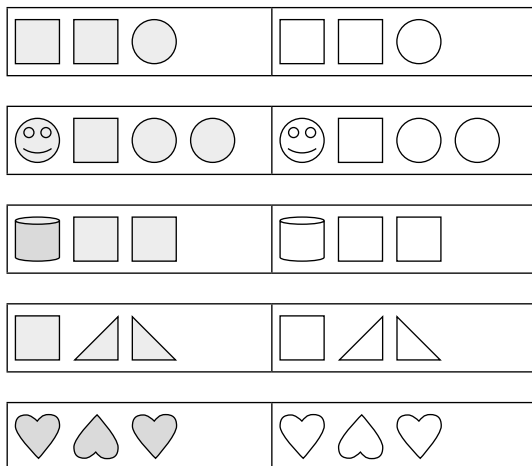

Umsebenzi Wokubakhulisa 3.8: Izimpendulo

Ukubala

Kungaki?

okuthathu **7**

iziyingi **4**

ukuhlano **4**

izikwele **4**

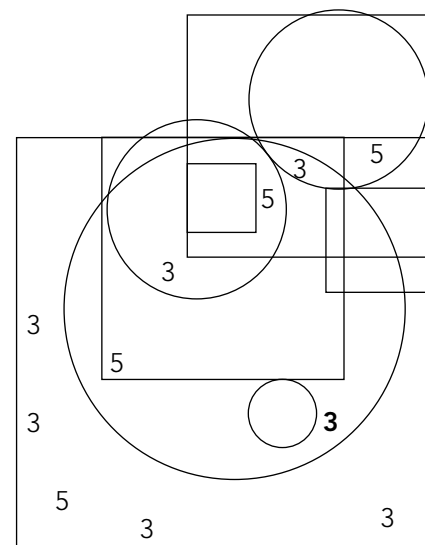

Umsebenzi Wokubakhulisa 3.9

What is my number?

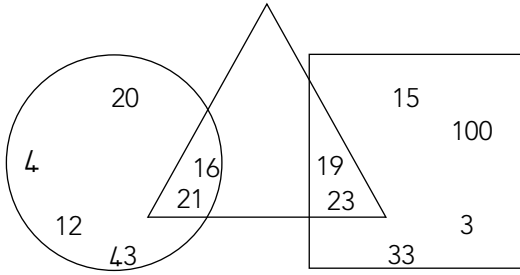

1. Yinombolo esesiyingini. Yinkulu ngoku-1 e-11. _____
2. Yinombolo esesikweleni. Iwumphumela we-13 + 2. _____
3. Yinombolo ekunxantathu. Iza ngaphambili kwama-20. _____

Umsebenzi Wokubakhulisa 3.10

Umdlalo wemicibosholo

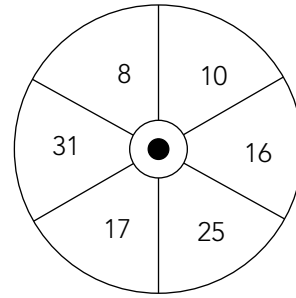

1. Uma kusetshenziswe umcibisholo o-1 imiphumela ephakeme ithini? _____
2. Imiphumela kaBen ngama-49. Uthole ziphi izinombolo ezimbili? _____, _____.
3. Imiphumela kaSipho ngama-20. Imicibisholo emibili ingene enombolweni efanayo? _____

Umsebenzi Wokubakhulisa 3.11

Zingaki izikwele?

A				
B				
C				
D				

Zingaki izikwele kulokhu:

Umugqa A? _____

Umugqa B? _____

Umugqa D? _____

Hlanganisa inani lamabhulokhi emigqeni C no-B _____

Umsebenzi Wokubakhulisa 3.12

Inombolo 12

_____ + 1 = 12

_____ + 3 = 12

_____ + 5 = 12

_____ + 7 = 12

_____ + 9 = 12

_____ + 12 = 12

Umsebenzi Wokubakhulisa 3.9: Izimpendulo

Yini inombolo yami?

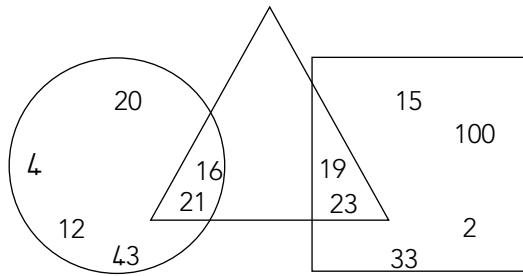

1. Yinombolo esesiyingini. Yinkulu ngoku-1 e-11. **12**
2. Yinombolo esesikweleni. lwumphumela we-13 + 2. **15**
3. Yinombolo ekunxantathu. Iza ngaphambili kwama-20. **19**

Umsebenzi Wokubakhulisa 3.10: Izimpendulo

Umdlalo wemicibosholo

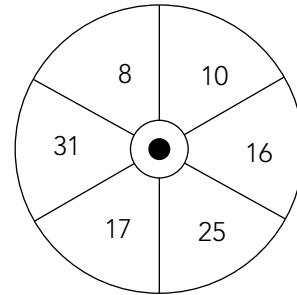

1. Uma kusetshenziswe umcibisholo o-1 imiphumela ephakeme ithini? **31**
2. Imiphumela kaBen ngama-49. Uthole ziphi izinombolo ezimbili? **8, 10.**
3. Imiphumela kaSipho ngama-20. Imicibisholo emibili ingene enombolweni efanayo? **10**

Umsebenzi Wokubakhulisa 3.11: Izimpendulo

Zingaki izikwele?

A				
B				
C				
D				

Zingaki izikwele kulokhu:

Umugqa A? **4**

Umugqa B? **4**

Umugqa D? **4**

Hlanganisa inani lamabhulokhi emigqeni C no-B **8**

Umsebenzi Wokubakhulisa 3.12: Izimpendulo

Inombolo 12

$$11 + 1 = 12$$

$$9 + 3 = 12$$

$$7 + 5 = 12$$

$$5 + 7 = 12$$

$$3 + 9 = 12$$

$$0 + 12 = 12$$

Umsebenzi Wokubakhulisa 3.13

Imidlalo kamakhalekhkwini



Yiziphi izinhlamvu ozibonayo uma ubheka lezi zinombolo?

5	1	6	3	2	8	4	7
---	---	---	---	---	---	---	---

Umsebenzi Wokubakhulisa 3.14

Lingubani igama?



Bheka okhiye futhi ubone ukuthi yimuphi umbala opelwa yilezi zinombolo:

3 2 5 _____

Lokhu ukwenza ngamehlo akho:

4 2 2 _____

Igama lomfana:

6 3 2 5 _____

Umsebenzi Wokubakhulisa 3.15

Hlanganisa



Hlanganisa izinombolo ezikuyinkinobho efanayo nalezi zinhlamvu:

$D + F + W = \underline{\quad}$

$X + E + R = \underline{\quad}$

$F + F + Z = \underline{\quad}$

$C + F + R = \underline{\quad}$

Umsebenzi Wokubakhulisa 3.16

Okunye ukuhlanganisa okwengeziwe



Hlanganisa izinombolo ezenza igama elithi **RED**. _____

Hlanganisa izinombolo ezenza igama elithi **SEE**. _____

Hlanganisa izinombolo ezenza igama elithi **FRED**. _____

Umsebenzi Wokubakhulisa 3.13: Izimpendulo

Imidlalo kamakhalekhukhwini



Yiziphi izinhlamvu ozibonayo uma ubheka lezi zinombolo?

5	1	6	3	2	8	4	7
D	W	F	R	E	X	S	Z

Umsebenzi Wokubakhulisa 3.14: Izimpendulo

Lingubani igama?



Bheka okhiye futhi ubone ukuthi yimuphi umbala opelwa yilezi zinombolo:

3 2 5 **RED**

Lokhu ukwenza ngamehlo akho:

4 2 2 **SEE**

Igama lomfana:

6 3 2 5 **FRED**

Umsebenzi Wokubakhulisa 3.15: Izimpendulo

Hlanganisa



Hlanganisa izinombolo ezikuyinkinobho efanayo nalezi zinhlamvu:

$$D + F + W = 12$$

$$X + E + R = 13$$

$$F + F + Z = 19$$

$$C + F + R = 18$$

Umsebenzi Wokubakhulisa 3.16: Izimpendulo

Okunye ukuhlanganisa okwengeziwe



Hlanganisa izinombolo ezenza igama elithi **RED. 10**

Hlanganisa izinombolo ezenza igama elithi **SEE. 8**

Hlanganisa izinombolo ezenza igama elithi **FRED. 16**

Umsebenzi Wokubakhulisa 3.17

Yiqiniso noma liphutha?

Faka uphawu (✓). Uma impendulo yamukeleka.

Faka isiphambano (✗). Uma impendulo ingamukeleki.

$4 + 13 = 20$

$5 + 5 + 5 = 15$

$6 + 7 + 3 = 17$

$20 - 5 - 6 = 8$

$17 - 5 - 3 = 9$

$18 - 10 - 3 = 9$

Umsebenzi Wokubakhulisa 3.18

Yiqiniso noma liphutha?

Faka uphawu (✓). Uma impendulo yamukeleka.

Faka isiphambano (✗). Uma impendulo ingamukeleki.

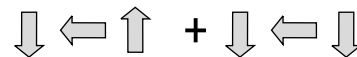
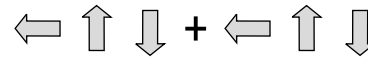
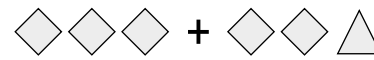
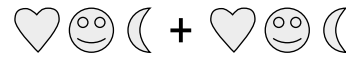

Umsebenzi Wokubakhulisa 3.19

Utholani?

Uma ubala ngaku-2 kusukela koku-2 uya ema-20?

Uma ubala ngaku-5 usukela koku-5 uya ema-50?

Uma ubala ngaku-1 usukela e-11 uya ema-31?

Uma ubala ngamashumi usukela e-0 – 100?

Umsebenzi Wokubakhulisa 3.20

Zingaki izikwele ezincane?

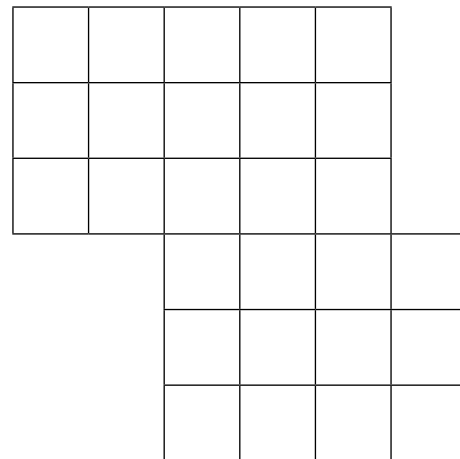

_____?

Umsebenzi Wokubakhulisa 3.17: Izimpendulo

Yiqiniso noma liphutha?

Faka uphawu (✓). Uma impendulo yamukeleka.

Faka isiphambano (✗). Uma impendulo ingamukeleki.

$4 + 13 = 20$

✗

$5 + 5 + 5 = 15$

✓

$6 + 7 + 3 = 17$

✗

$20 - 5 - 6 = 8$

✗

$17 - 5 - 3 = 9$

✓

$18 - 10 - 3 = 9$

✗

Umsebenzi Wokubakhulisa 3.18: Izimpendulo

Yiqiniso noma liphutha?

Faka uphawu (✓). Uma impendulo yamukeleka.

Faka isiphambano (✗). Uma impendulo ingamukeleki.



✓



✗

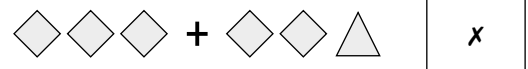

✗

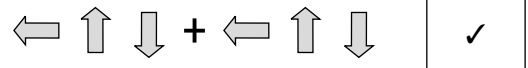

✓

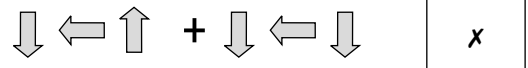

✗

Umsebenzi Wokubakhulisa 3.19: Izimpendulo

Utholani?

Uma ubala ngaku-2 kusukela koku-2 uya ema-20?

10

Uma ubala ngaku-5 usukela koku-5 uya ema-50?

10

Uma ubala ngaku-1 usukela e-11 uya ema-31?

21

Uma ubala ngamashumi usukela e-0 – 100?

10

Umsebenzi Wokubakhulisa 3.20: Izimpendulo

Zingaki izikwele ezincane?

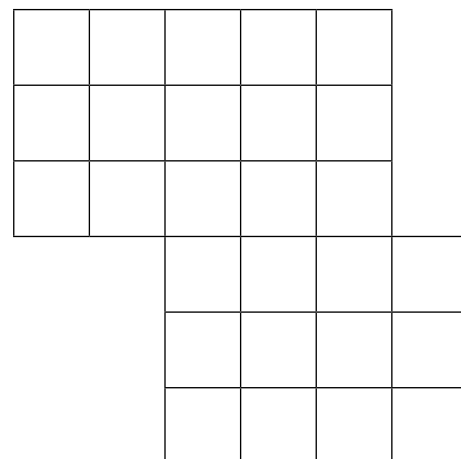

27 tikwele

Umsebenzi Wokubakhulisa 3.21

Thola indlela

Qala ebusweni bokuqala uthole indlela eya ebusweni bokugcina ngokudlula ebusweni obujabulile bodwa. Ungadluli ebusweni obungajabulile.

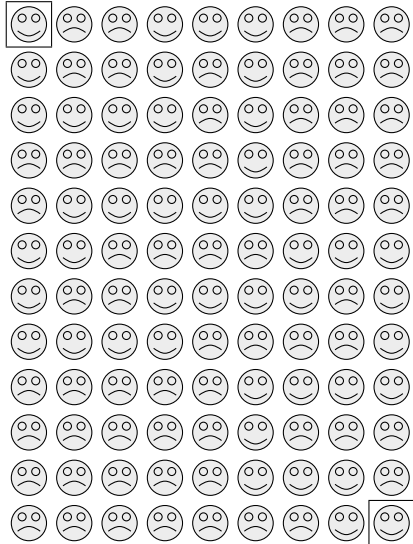

Umsebenzi Wokubakhulisa 3.22

Bheka izinombolo ezingezansi?

Faka umbala kugridi yegama laleyo nombolo.

s	o	n	e	t	o	w
f	i	v	e	s	e	v
n	r	t	h	r	e	e
i	t	e	n	s	i	x
n	w	e	i	g	h	t
e	o	f	o	u	r	b

- 1 10
- 3 9
- 2 4
- 5 8

Umsebenzi Wokubakhulisa 3.23

Obani abangani bami?

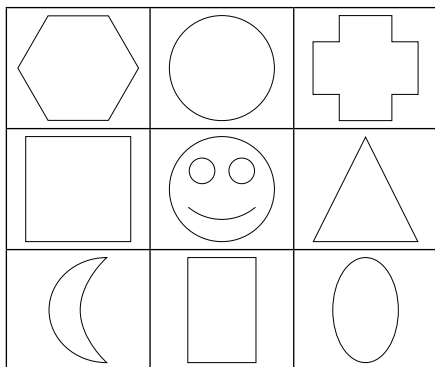

Faka umbala imifanekiso:

- Isiphambano-owolintshi.
- Unxantathu-obomvana.
- Indingilizi-oluhlaza okwesibhakabhaka.
- Onxande-oluhlaza okotshani.
- Ubuso ophuzi.

Umsebenzi Wokubakhulisa 3.24

Thola izakhiwo

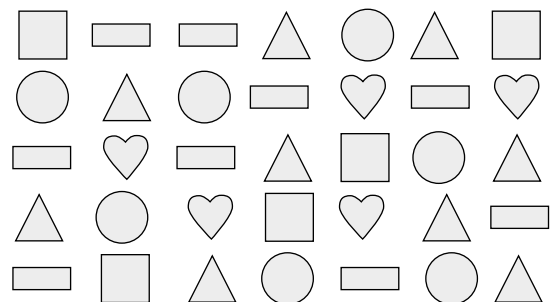

Bangaki?

- Bangaki onxantathu: _____
- Bangaki onxande: _____
- Zingaki izindingilizi: _____
- Zingaki izikwele: _____

Umsebenzi Wokubakhulisa 3.25





Qedela le Sudoku

	2	3	4
3	4	1	
2	1	4	
	3	2	1





Umsebenzi Wokubakhulisa 3.26

Imali





Khetha uhlamvu lwemali oluyinani eliphezulu:

1. 	2. 	3. 	4. 

Khetha uhlamvu lwemali oluyinani eliphansi:

1. 	2. 	3. 	4. 

Khetha uhlamvu lwemali enizolusebenzisa ukuthenga amaswidi abiza ama-35c:

1. 	2. 	3. 	4. 

Umsebenzi Wokubakhulisa 3.27

Yini engingayithenga?

Unama-R2,00. Ungawathenga amakhekhe asankomishi amathathu?

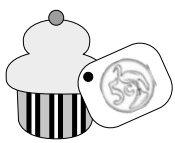

Unama-R5,00. Ungawathenga amakhekhe amabhola amathathu?



Umsebenzi Wokubakhulisa 3.28

Qedela le Sudoku

2	1	4	3
4			1
1			4
3	4	1	2

Umsebenzi Wokubakhulisa 3.25: Izimpendulo





Qedela le Sudoku

1	2	3	4
3	4	1	2
2	1	4	3
4	3	2	1





Umsebenzi Wokubakhulisa 3.26: Izimpendulo

Imali





Khetha uhlamvu lwemali oluyinani eliphezulu:

1. 	2. 	3. 	4. 

Khetha uhlamvu lwemali oluyinani eliphansi:

1. 	2. 	3. 	4. 

Khetha uhlamvu lwemali enizolusebenzisa ukuthenga amaswidi abiza ama-35c:

1. 	2. 	3. 	4. 

Umsebenzi Wokubakhulisa 3.27: Izimpendulo

Yini engingayithenga?

Unama-R2,00. Ungawathenga amakhekhe asankomishi amathathu?



yebo

Unama-R5,00. Ungawathenga amakhekhe amabhola amathathu?



cha

Umsebenzi Wokubakhulisa 3.28: Izimpendulo

Qedela le Sudoku

2	1	4	3
4	3	2	1
1	2	3	4
3	4	1	2

Umsebenzi Wokubakhulisa 3.29

Izibalo ezixovekile

Sebenzisa izinombolo ezisemabhokisini ukwenza izibalo.

$\square + \square = \square$
 $\square + \square = \square$
 $\square + \square + \square = \square$

Umsebenzi Wokubakhulisa 3.30

Izinombolo ezintathu

Bhala izinombolo ezi-3 emabhulokhini ezithi uma zihlanganiswa zakhe inombolo ephansi ekugcineni.

			15
			19
			26
			21

Umsebenzi Wokubakhulisa 3.31

Inani

Isilinda ngayinye inaliphi inani uma unxande enoku-4, isiyingi sinoku-3, unxantathu enoku-1 idayimane linokuyi-10? Bhala impendulo ebhokisini.

\square
 \square
 \square

Umsebenzi Wokubakhulisa 3.32

Faka umbala ukukhombisa impendulo

Faka umbala ezinombolweni ezihlangana zakhe eyokuqala ebhulokhini.

10	3	5	2	9	7	4	0
20	8	6	10	4	3	5	2
26	1	9	7	3	0	5	1

Umsebenzi Wokubakhulisa 3.29: Izimpendulo

Izibalo ezixovekile

Sebenzisa izinombolo ezisemabhokisini ukwenza izibalo.

$5 + 3 = 8$
 $12 + 0 = 5$
 $5 + 1 + 6 = 12$

Umsebenzi Wokubakhulisa 3.30: Izimpendulo

Izinombolo ezintathu

Bhala izinombolo ezi-3 emabhulokhini ezithi uma zihlanganiswa zakhe inombolo ephansi ekugcineni.

1	1	13	15
5	5	9	19
10	10	6	26
10	11	0	21

Umsebenzi Wokubakhulisa 3.31: Izimpendulo

Inani

Isilinda ngayinye inaliphi inani uma unxande enoku-4, isiyingi sinoku-3, unxantathu enoku-1 idayimane linokuyi-10? Bhala impendulo ebhokisini.

23
31
22

Umsebenzi Wokubakhulisa 3.32: Izimpendulo

Faka umbala ukukhombisa impendulo

Faka umbala ezinombolweni ezihlangana zakhe eyokuqala ebhulokhini.

10	3	5	2	9	7	4	0
10	3	5	2	9	7	4	0
20	8	6	10	4	3	5	2
20	8	6	10	4	3	5	2
26	1	9	7	3	0	5	1



Jika iMfundo
what I do matters

Jik'iMfundo is a programme to improve learning outcomes, funded by the National Education Collaboration Trust, the KwaZulu-Natal Department of Education and others.

THE PROGRAMME TO IMPROVE LEARNING OUTCOMES

The Shed
The Pines
9 Gordon Hill Road
Parktown
2193

Tel: +27 10 880 2431

Email: admin@pilo.co.za

ISBN: 978-1-990904-94-3